

JÄRNBENT STEYPA

Forsteyptar loftaplötur (filegran), 3. hæð

Yfirlitsmynd 1:50

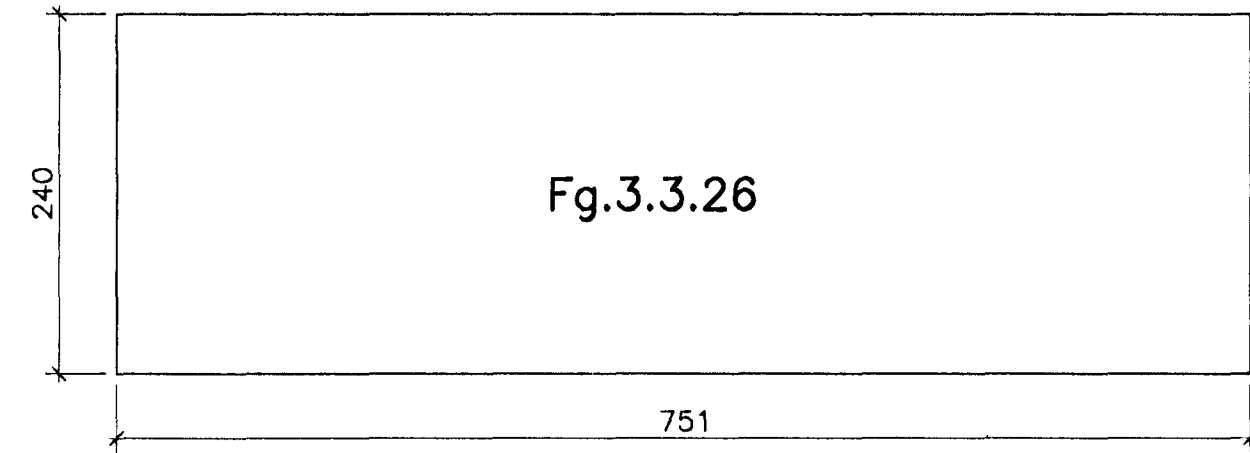
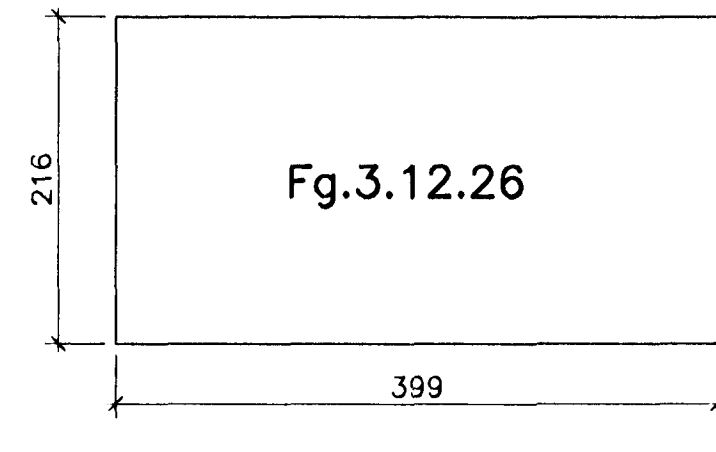
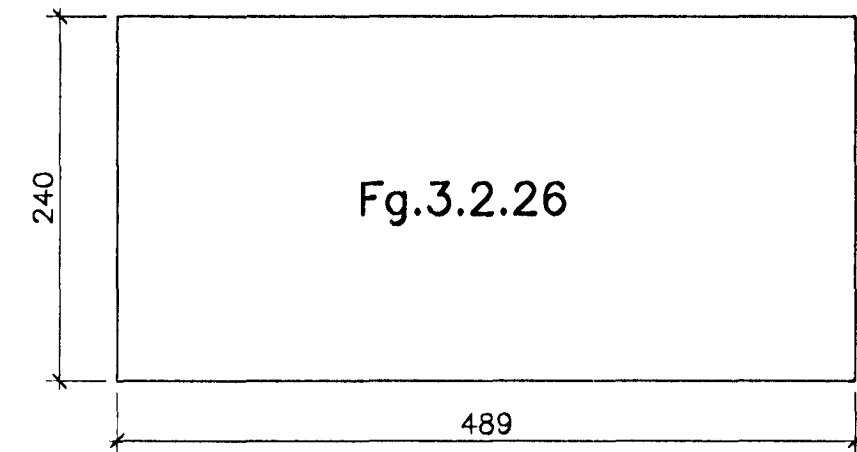
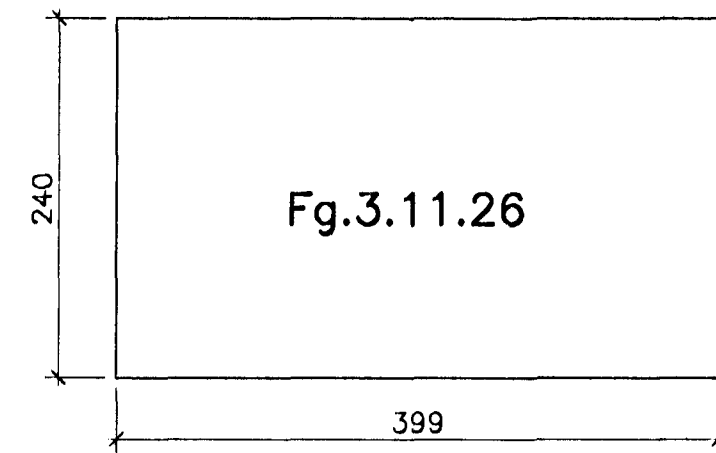
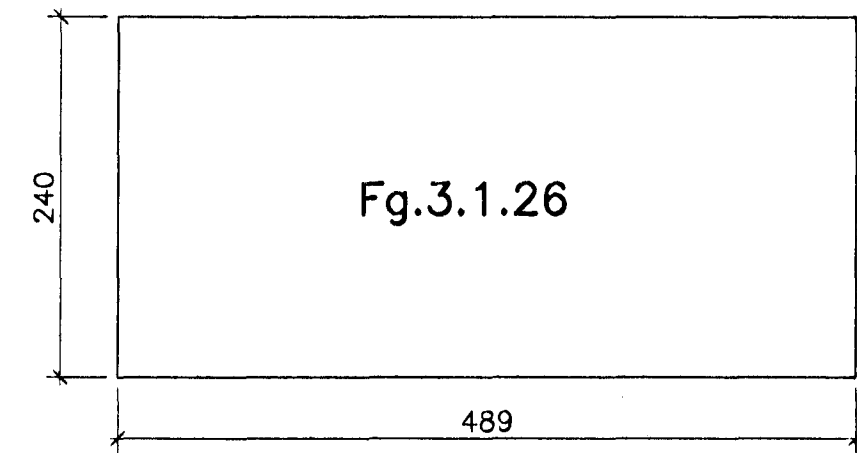

SKÝRINGAR:

Allar loftaplötur eru forsteyptar og forspennar 8 cm þykkar filegranplötur. Tengistigar (filegran-tróger) eru 14 cm háir með 90 cm bili. Forspennukaplar eru spennir í 1050 MPa og eru með 30 cm millibili. Sérmynd, sjá bl. 74.

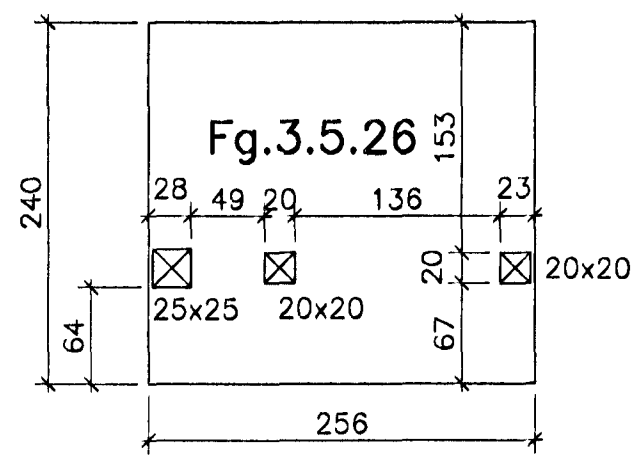
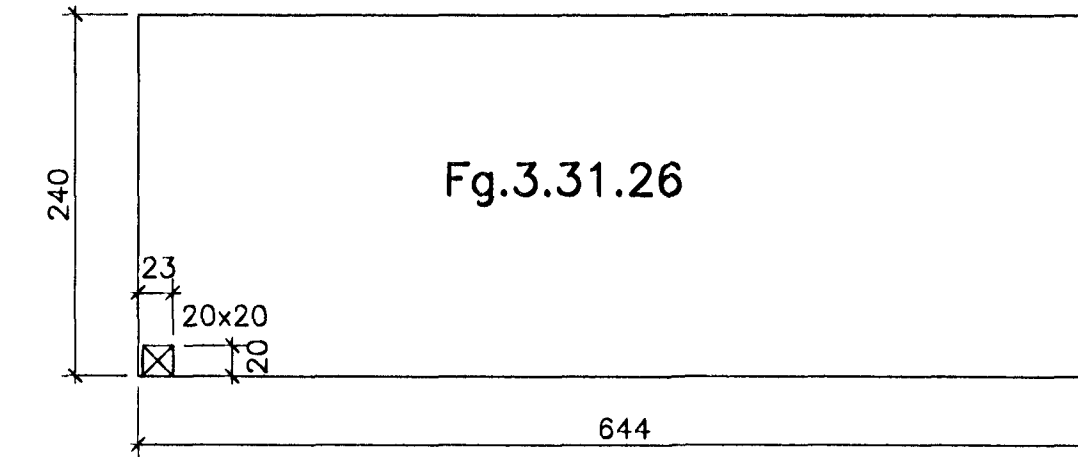
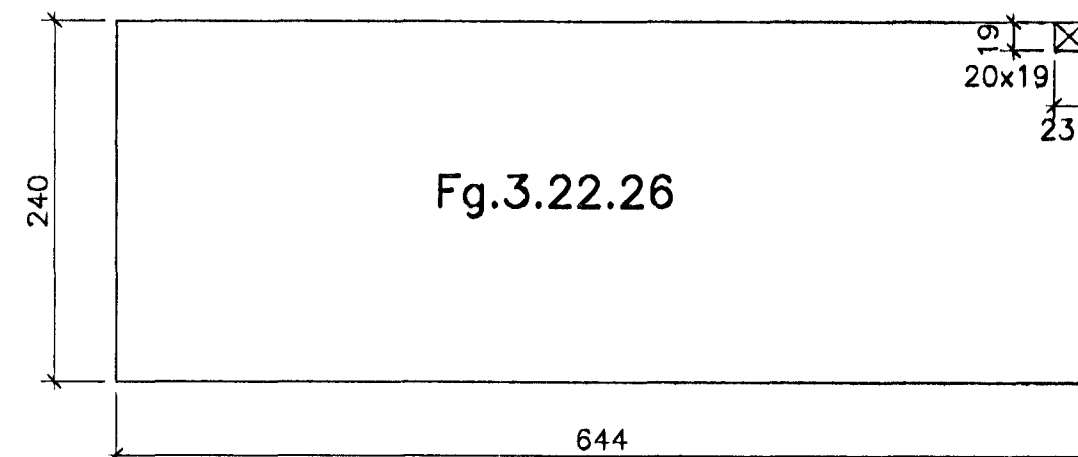
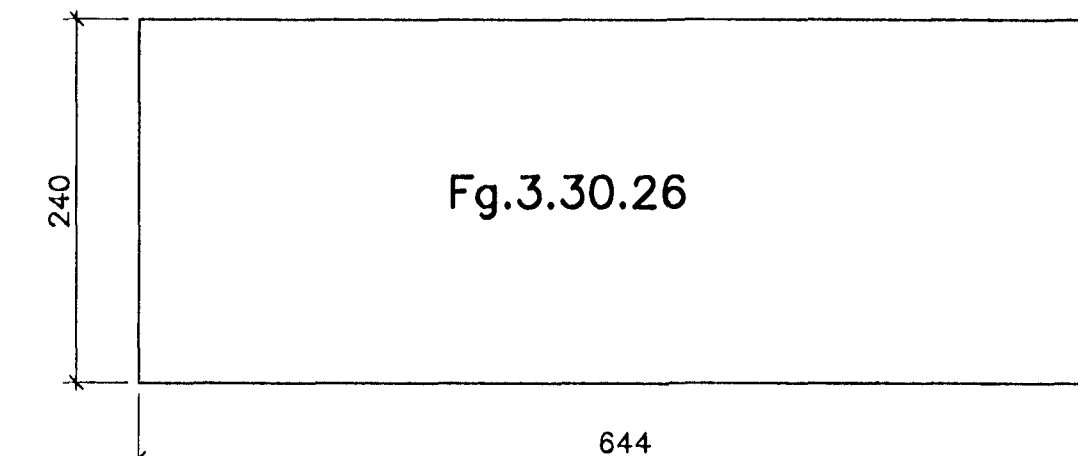
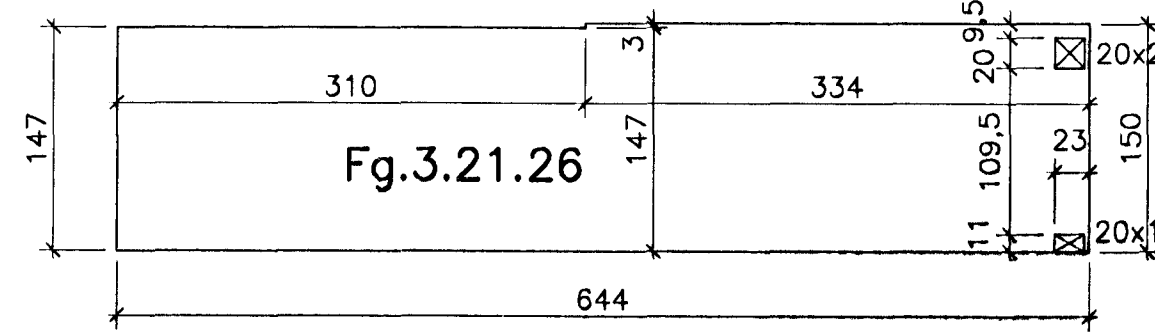
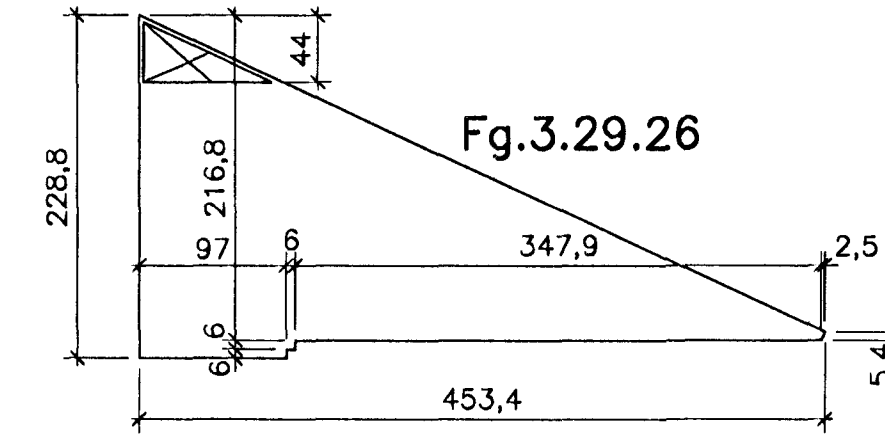
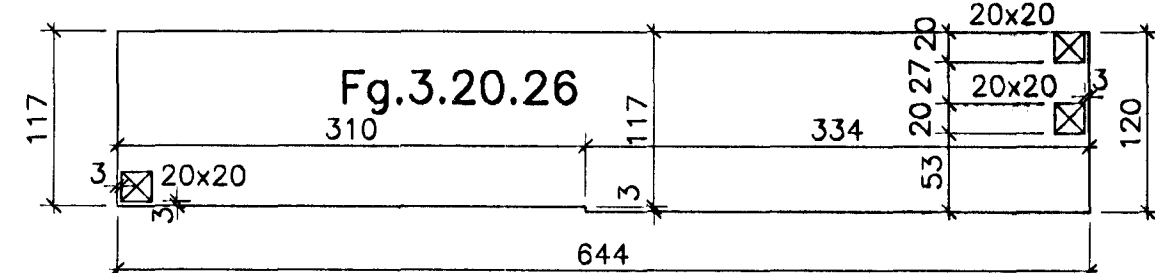
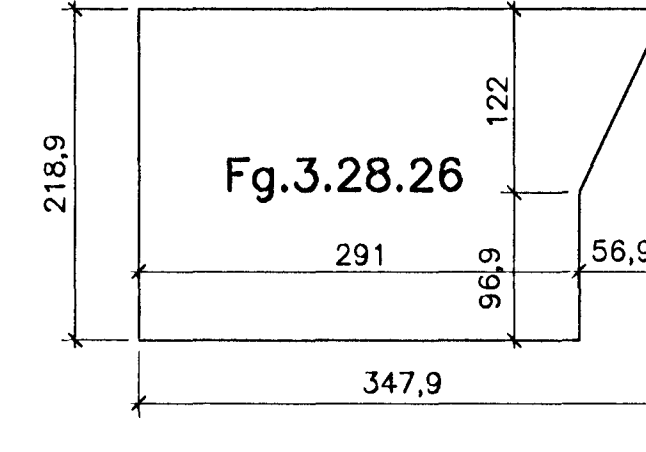
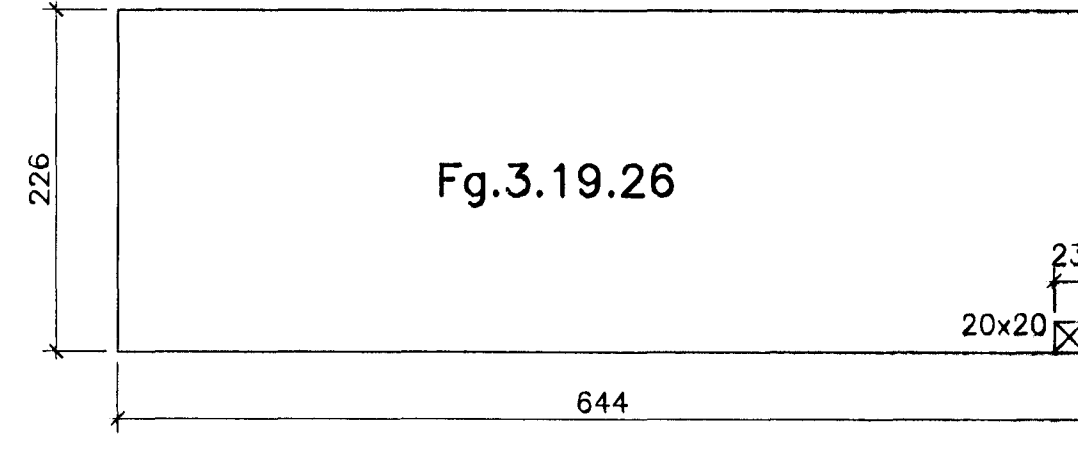
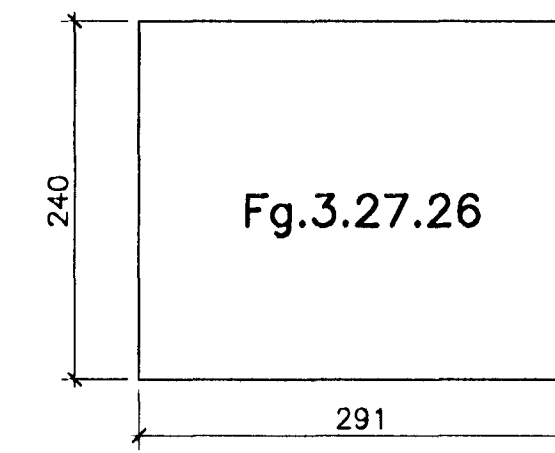
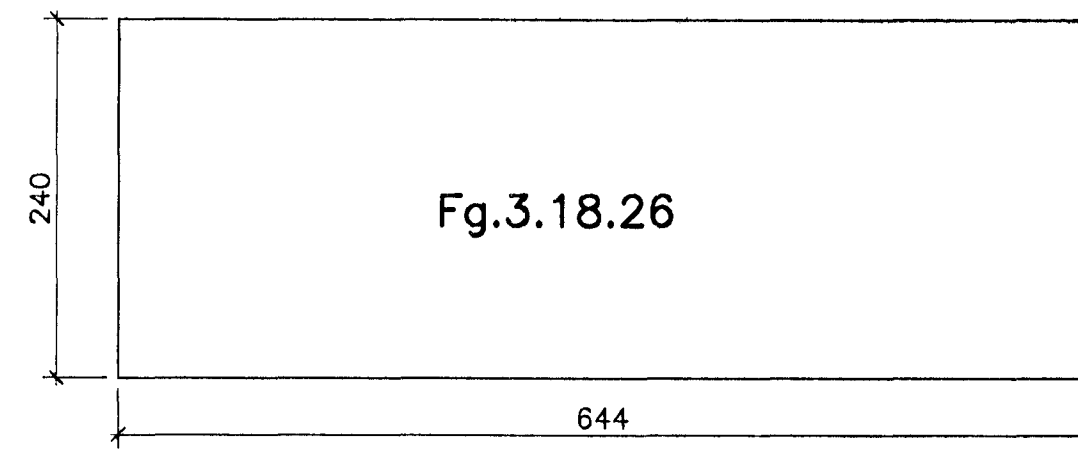
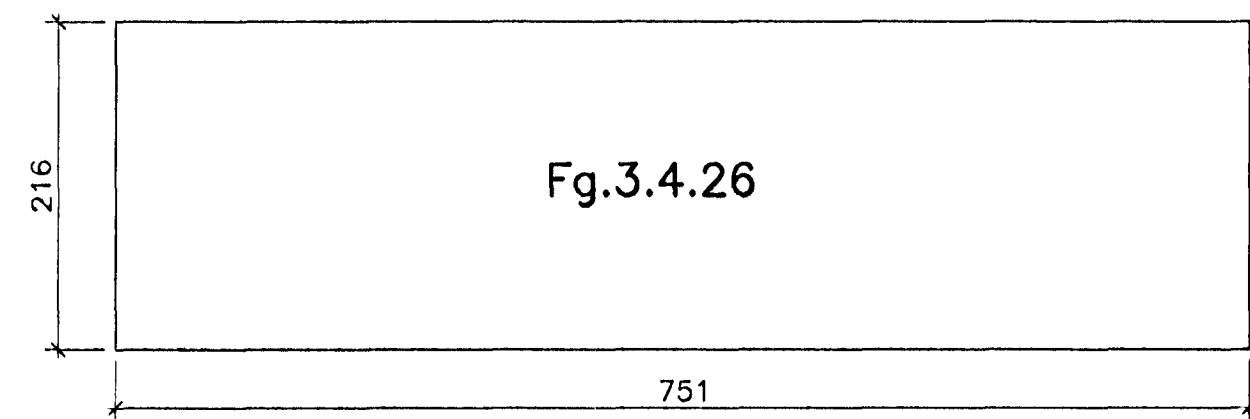

Fg.3.7.26 ekki til

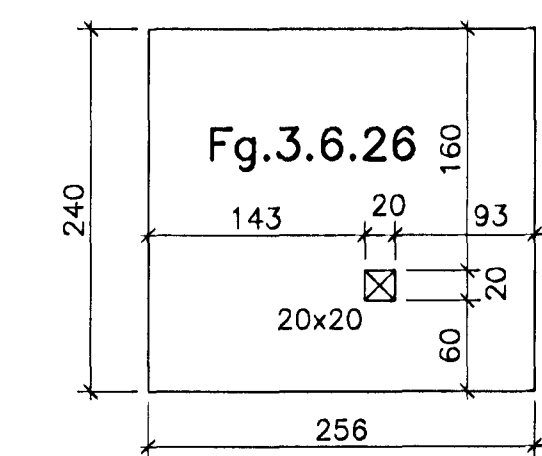
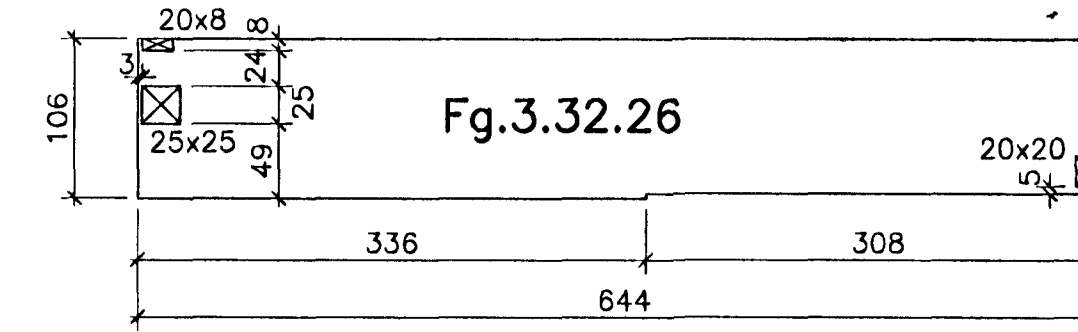
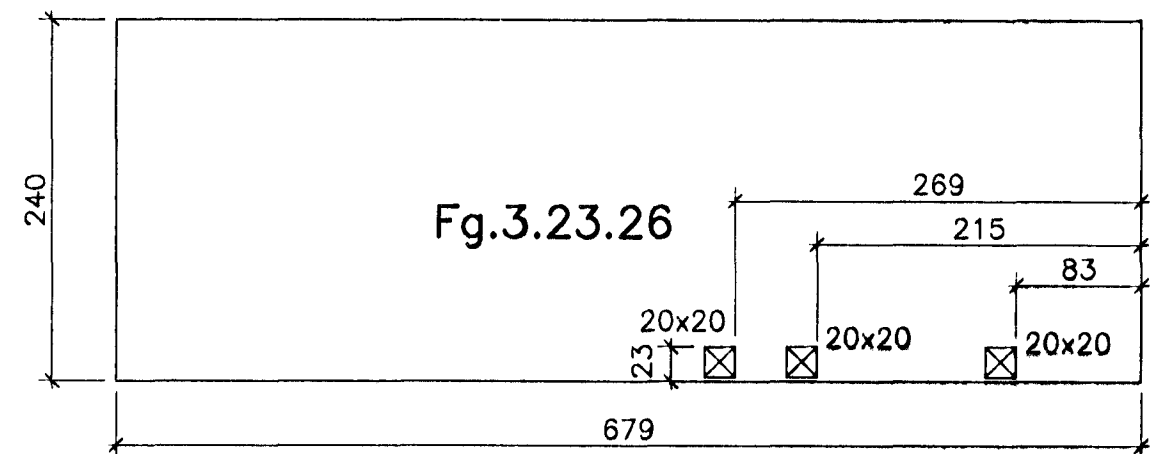
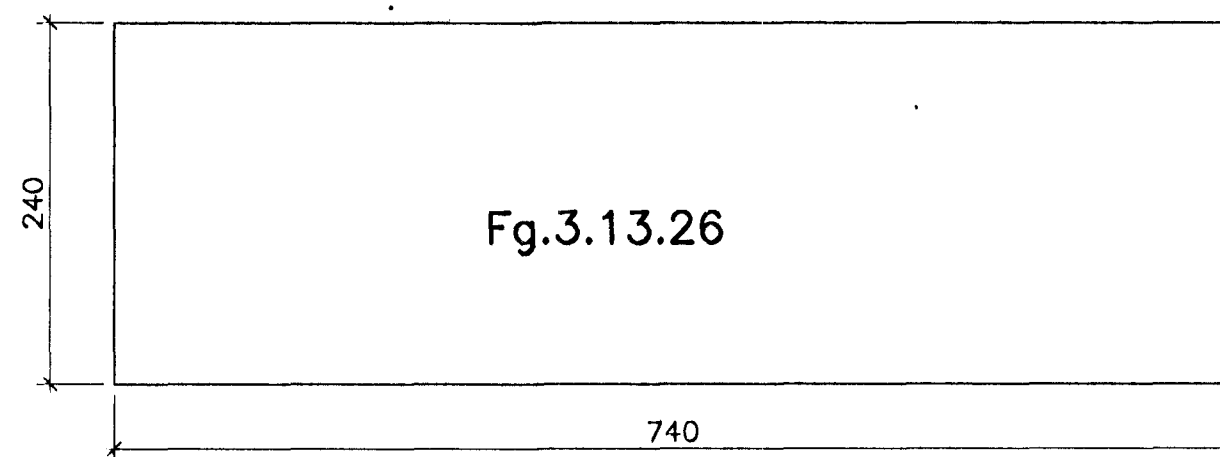

Fg.3.8.26 ekki til

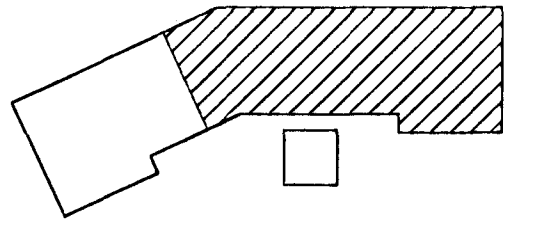
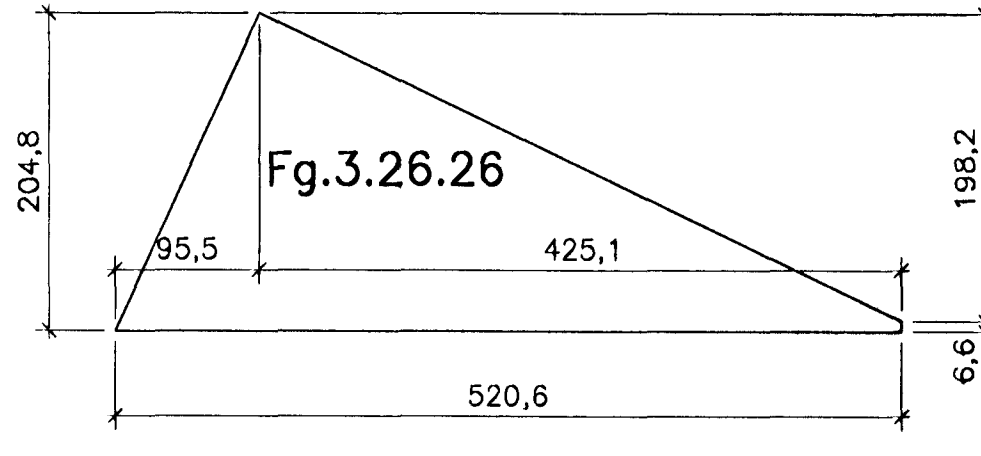
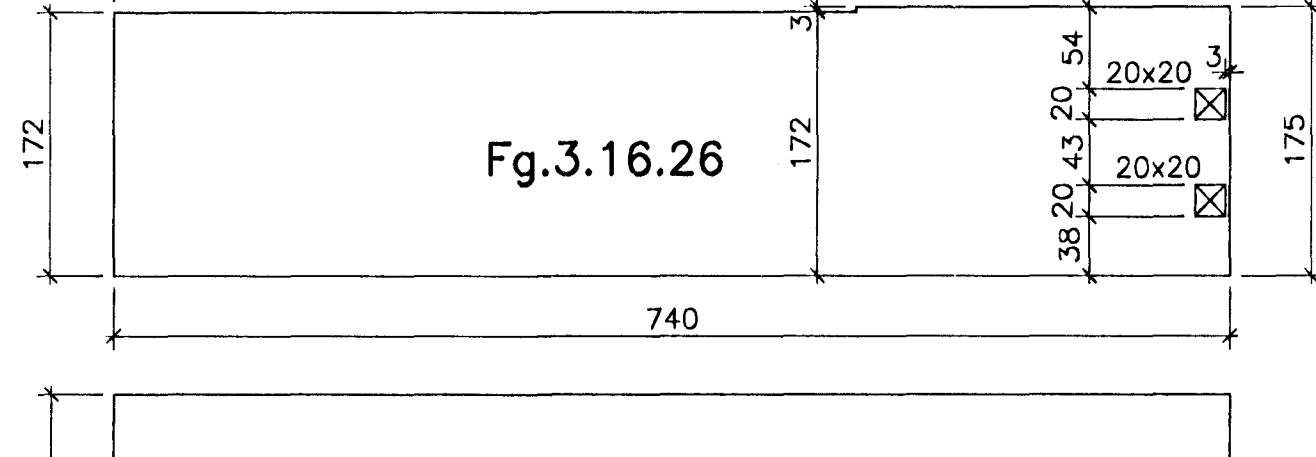
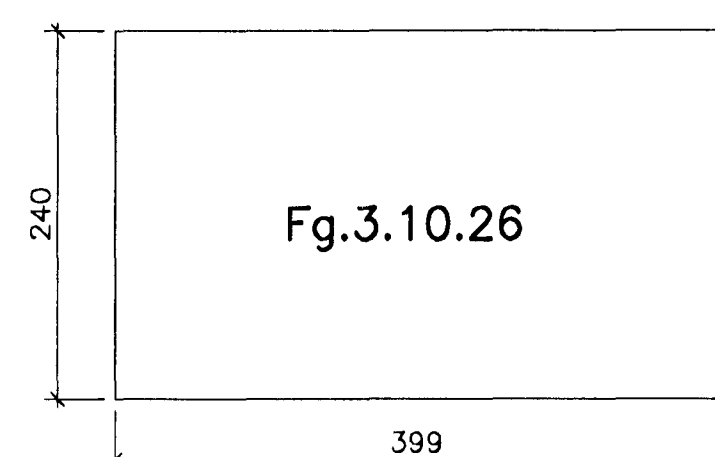
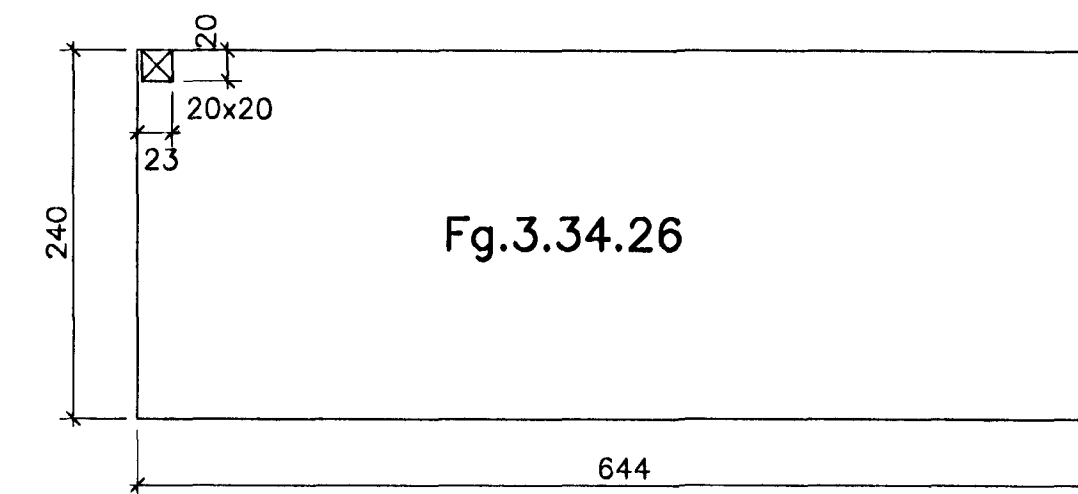
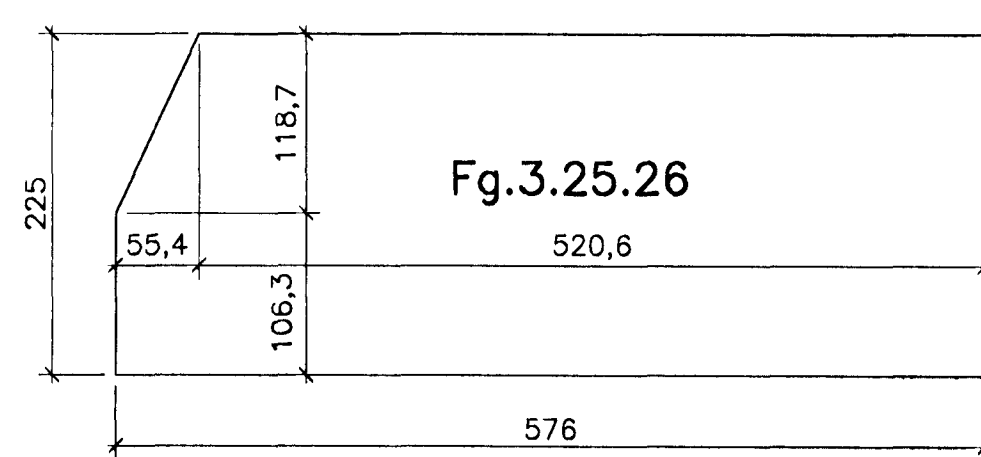
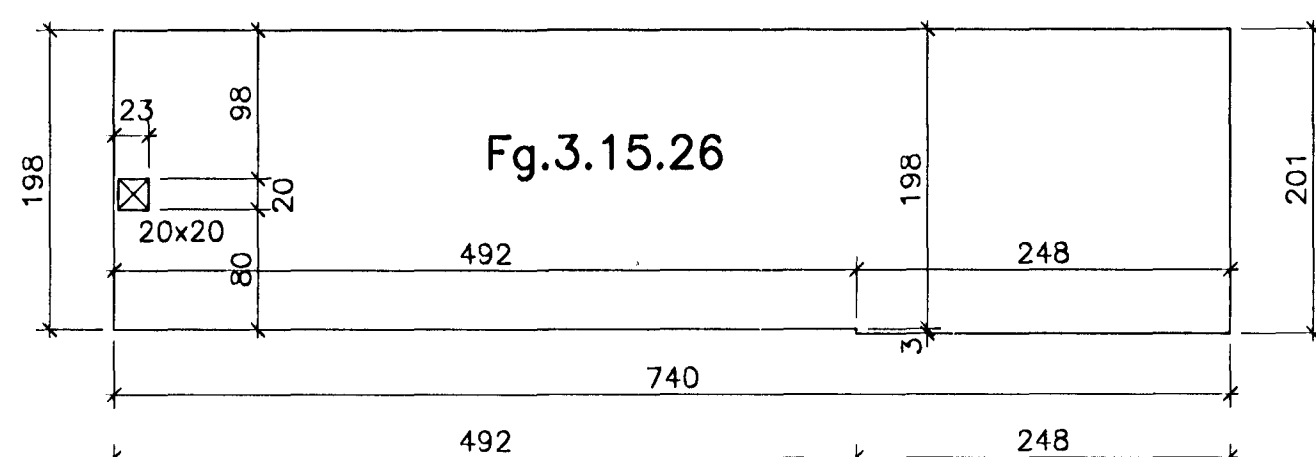
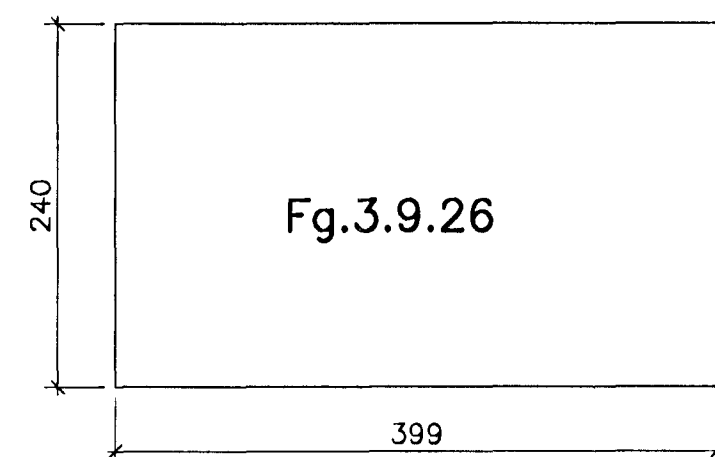
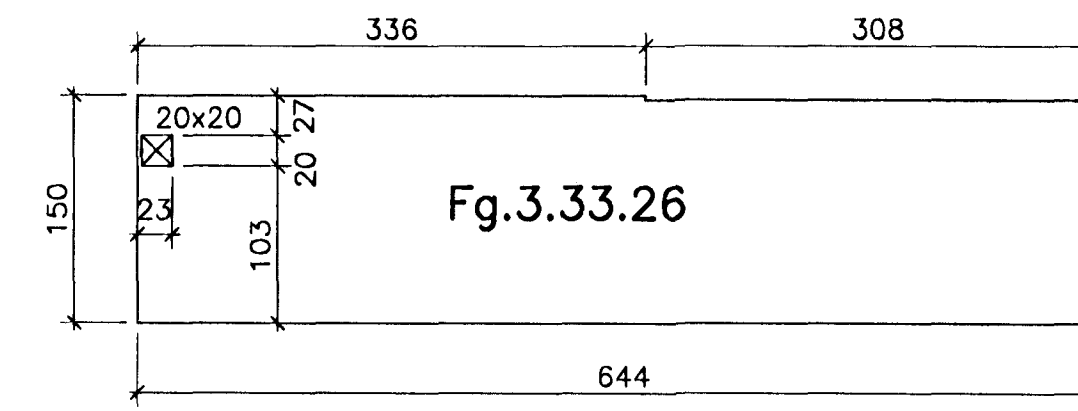
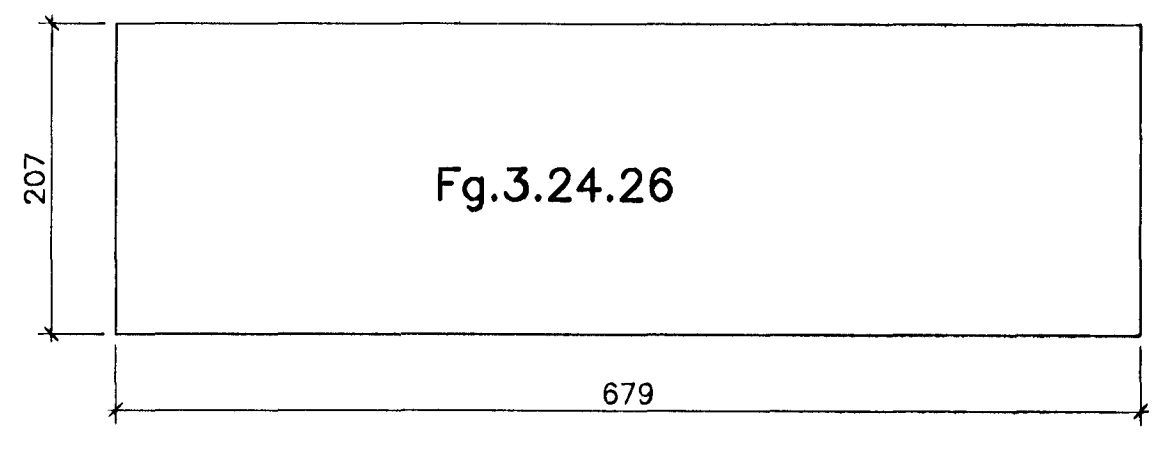
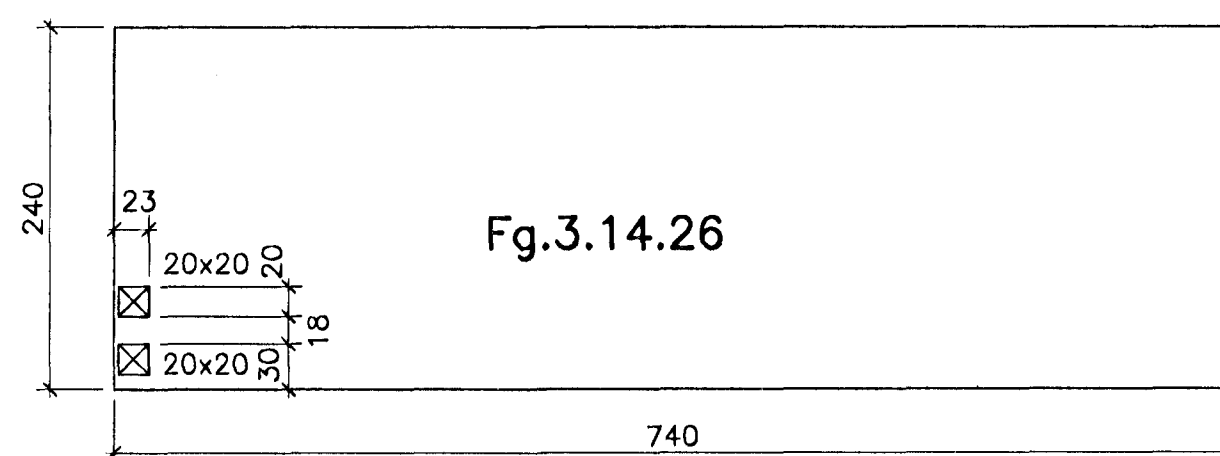

Breytingar:

Vífill Oddsson
101237-3629

Samþykkt þann
29 APR. 2005

TEIKNISTOFAN ÖDINSTORGI
Byggingafulltrúin í Hafnarfirði
F.h. Sigurbjartur Halldórsson

Verkefni: Lækjargata 26 Hafnarfirði
Heiti: Järnbent steypa: Forsteyptar loftaplötur (filegranplötur)
Hönnun: Vífill Oddsson verkfræðingur

VÍFILL ODDSSON VERKFRÆÐINGUR
kt. 101237-3629 FVFI - FRV
ÓDINGSGÖTU 7 REYKJAVÍK SIMI: 510-2200
M. 1:50 FAX: 510-2201
R. V.O./K.S.G.
T. K.S.G.
Dags. apríl 2005 Nr. 967-1-73