

JÄRNBENT STEYPA

Forsteyptar loftaplötur (filegran)

Yfirlitsmynd 1:50

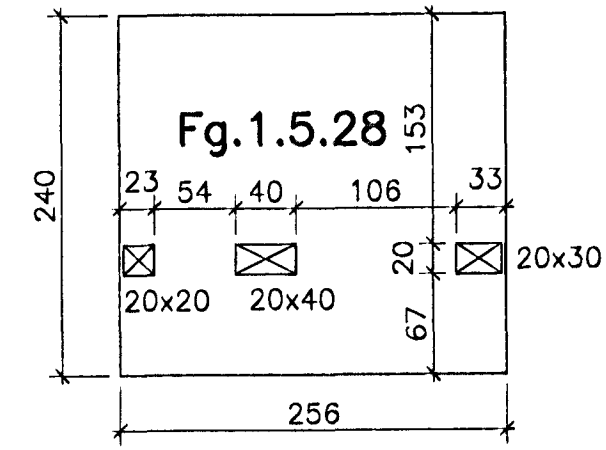
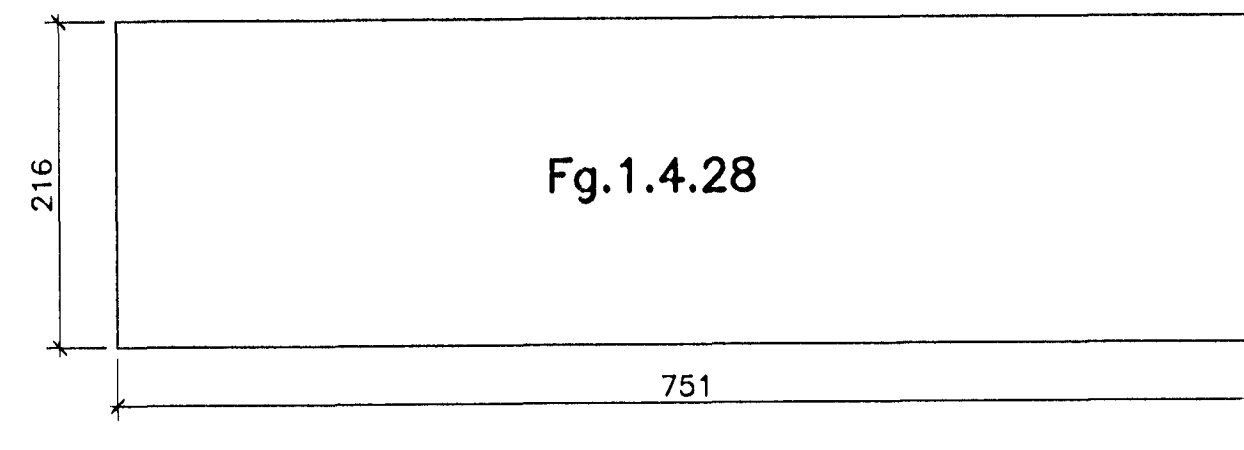
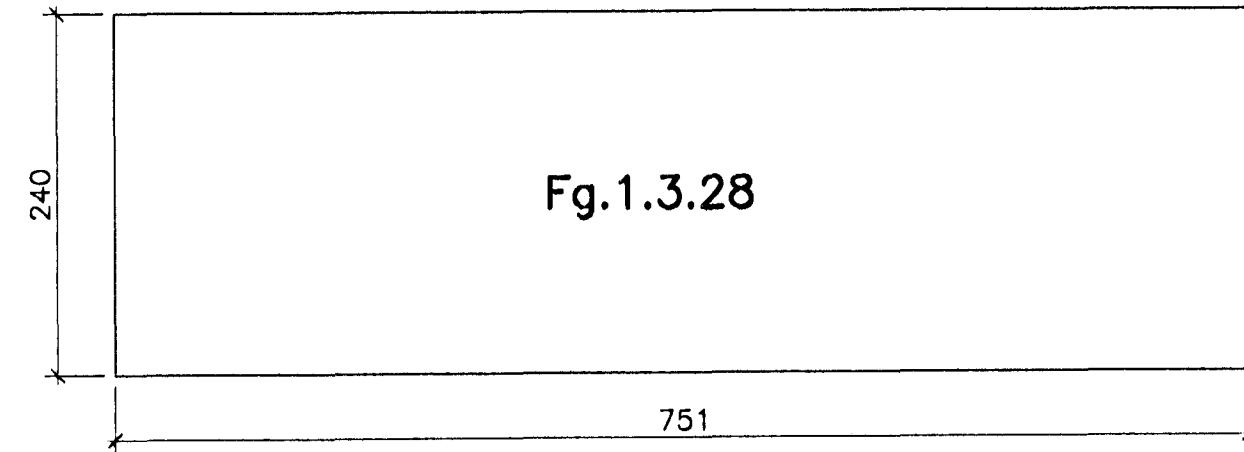
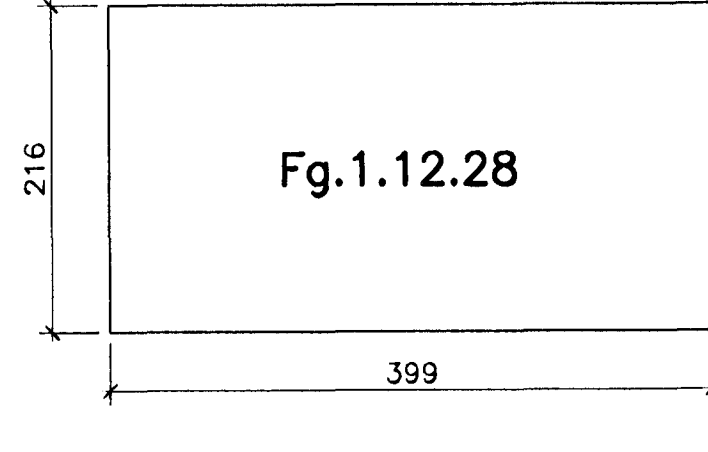
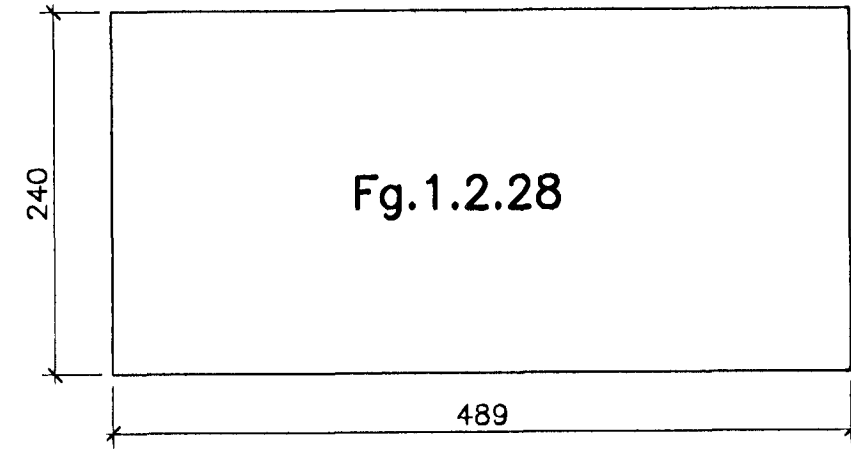
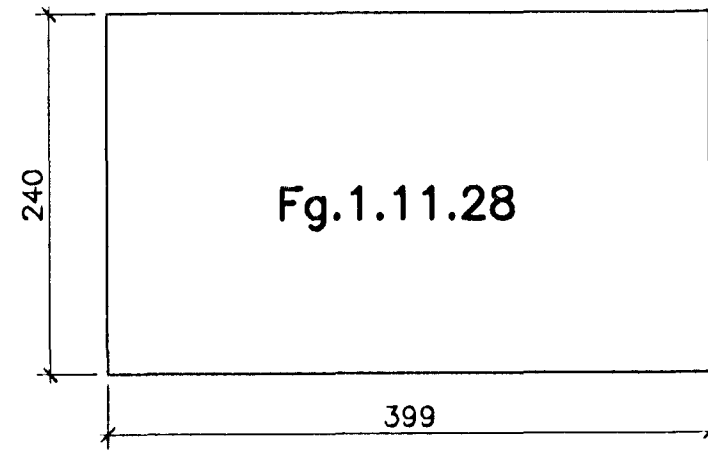
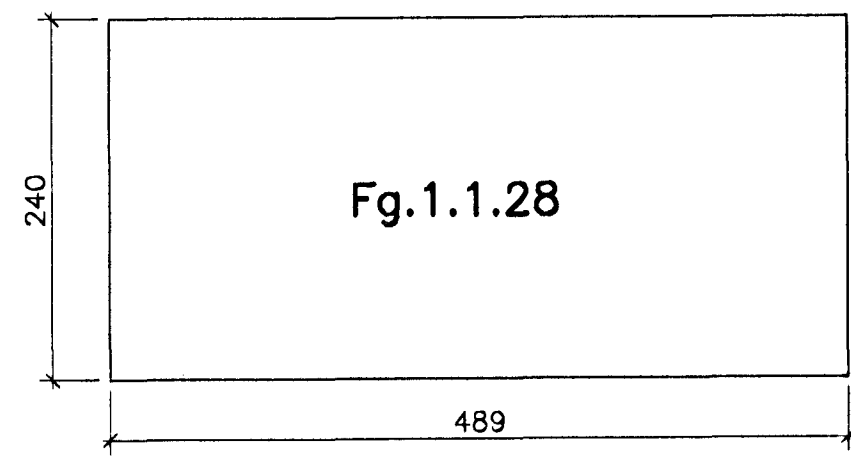

Fg.1.7.28
ekki til

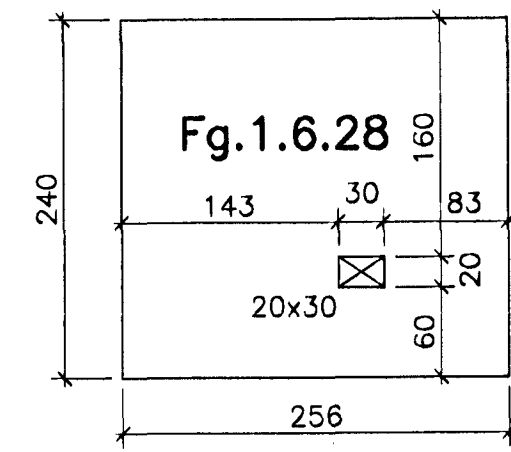

Fg.1.8.28
ekki til

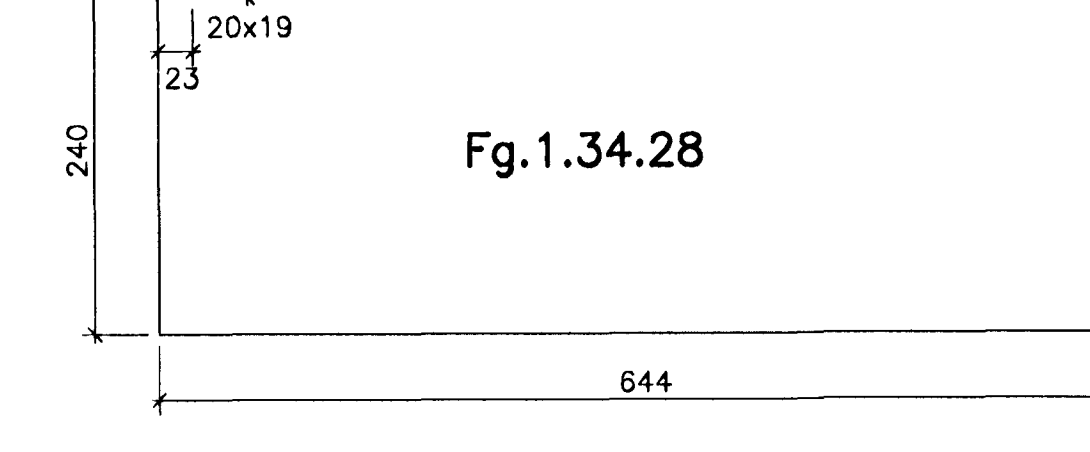
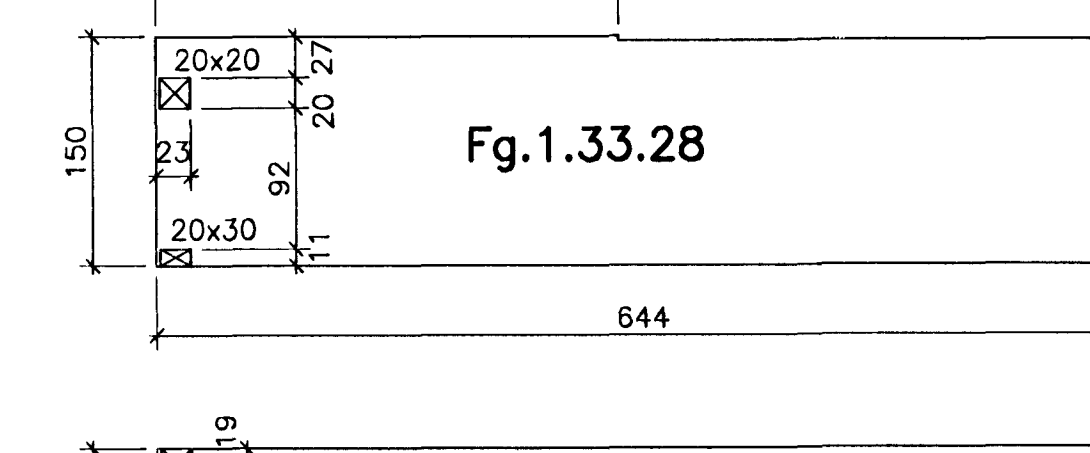
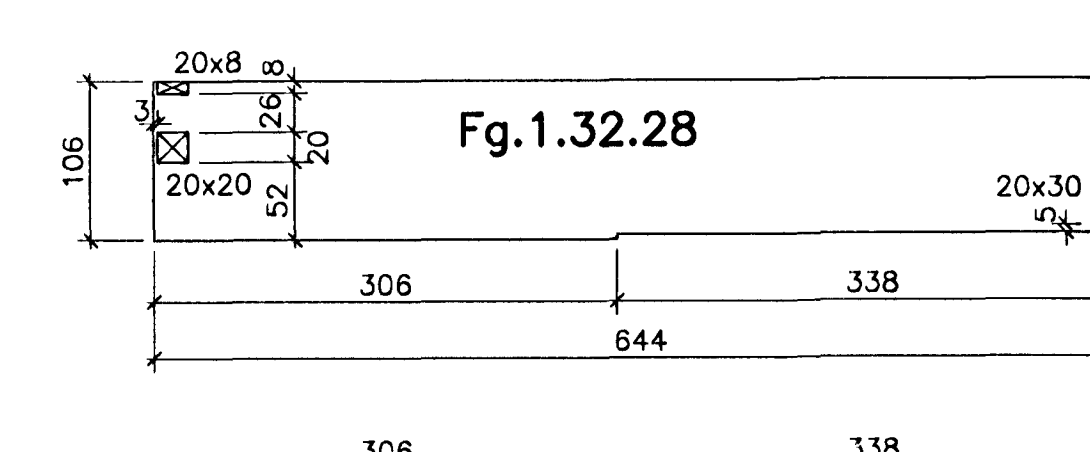
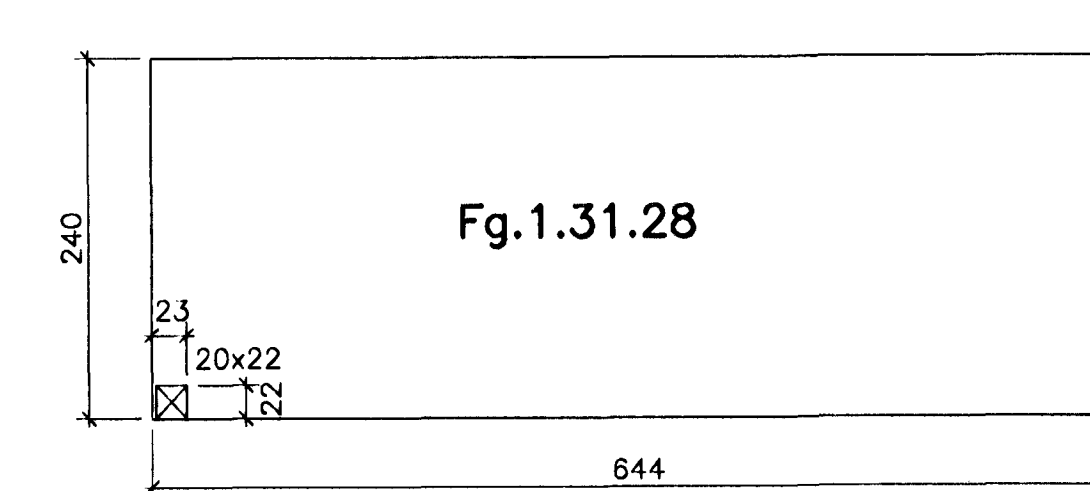
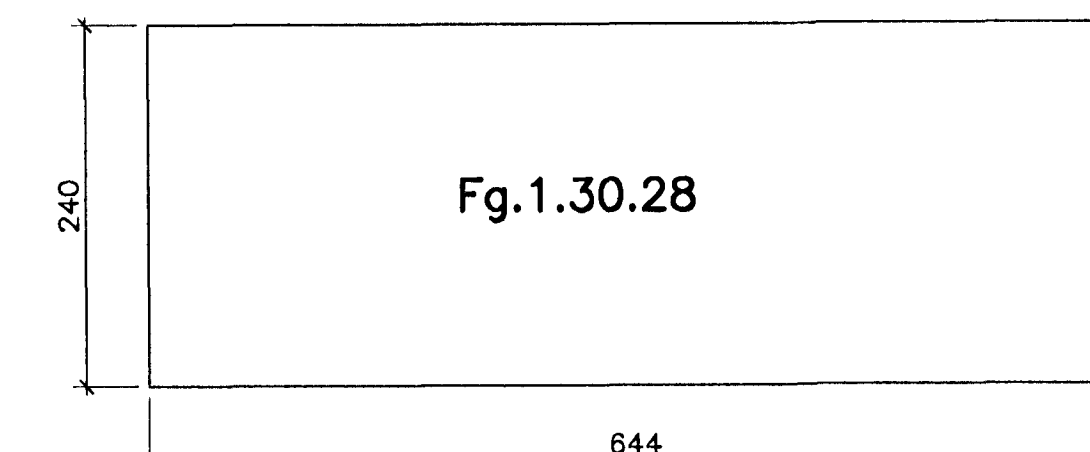
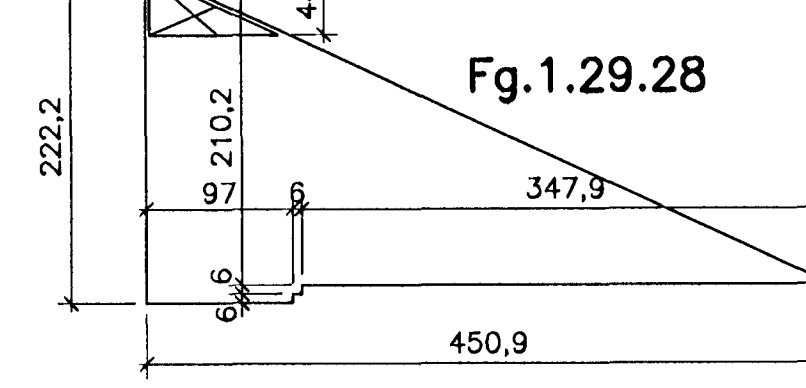
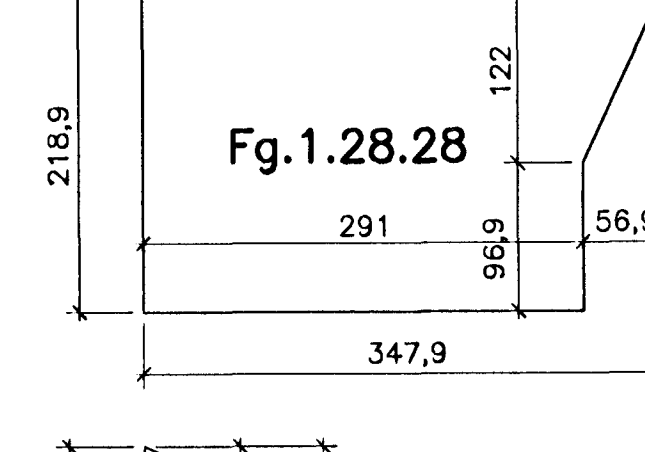
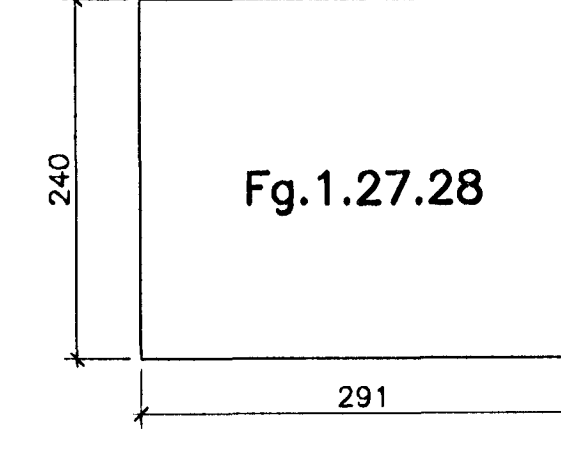
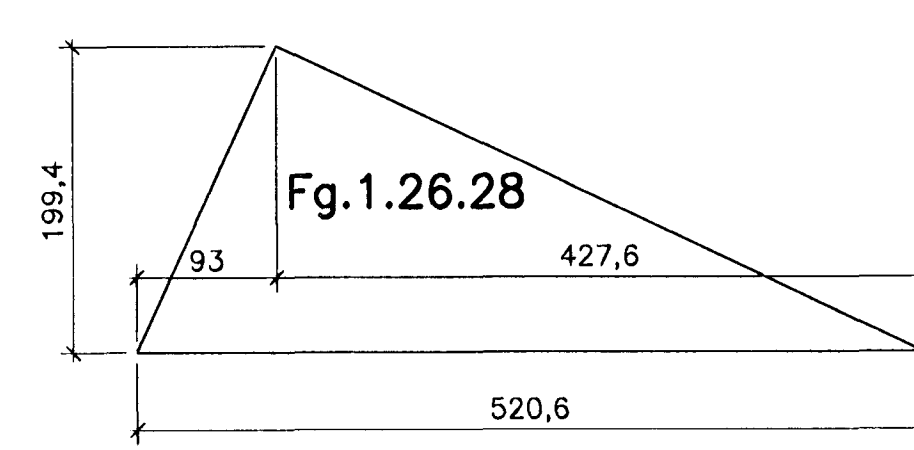
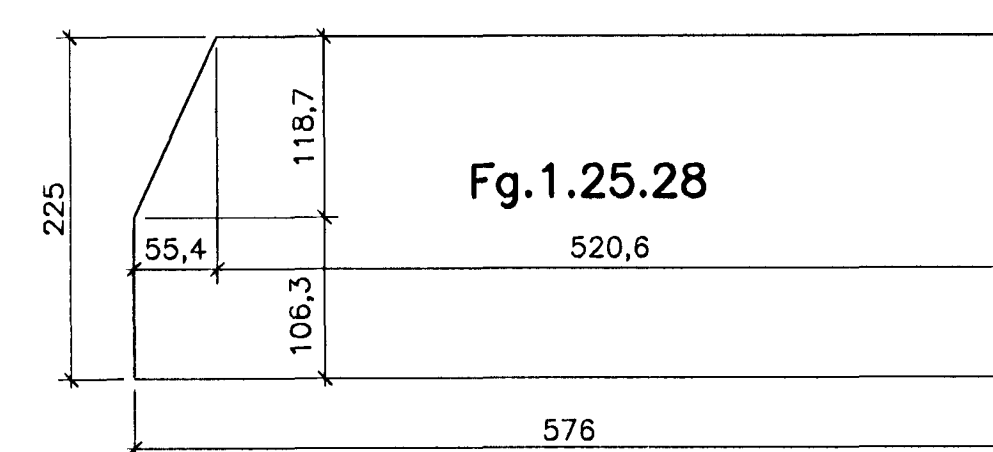
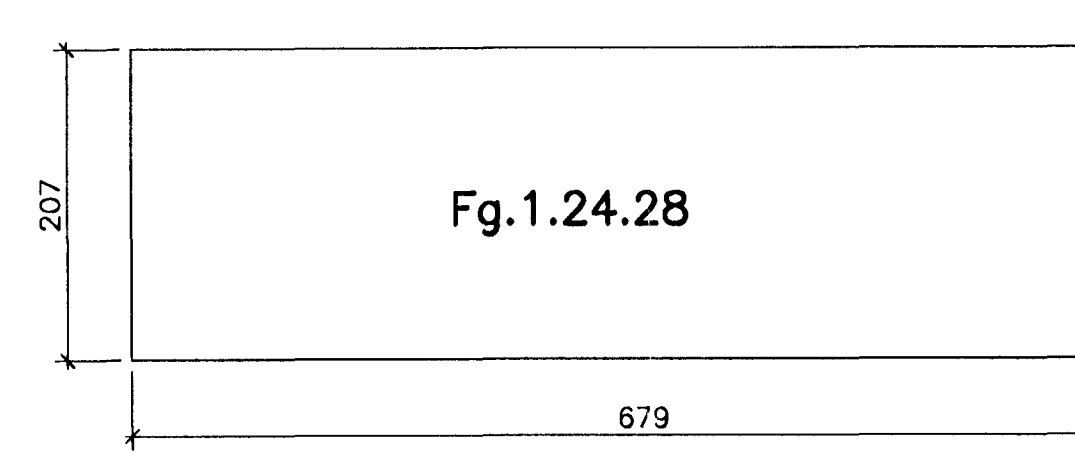
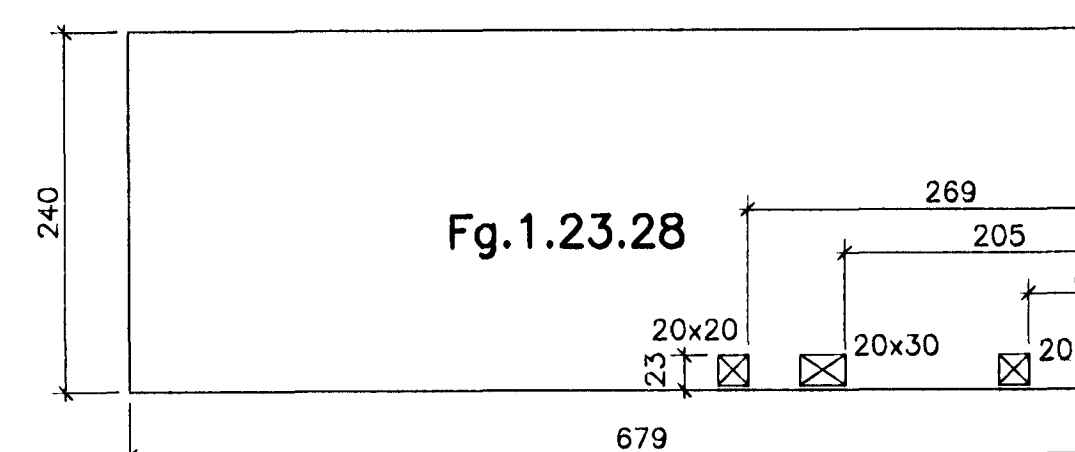
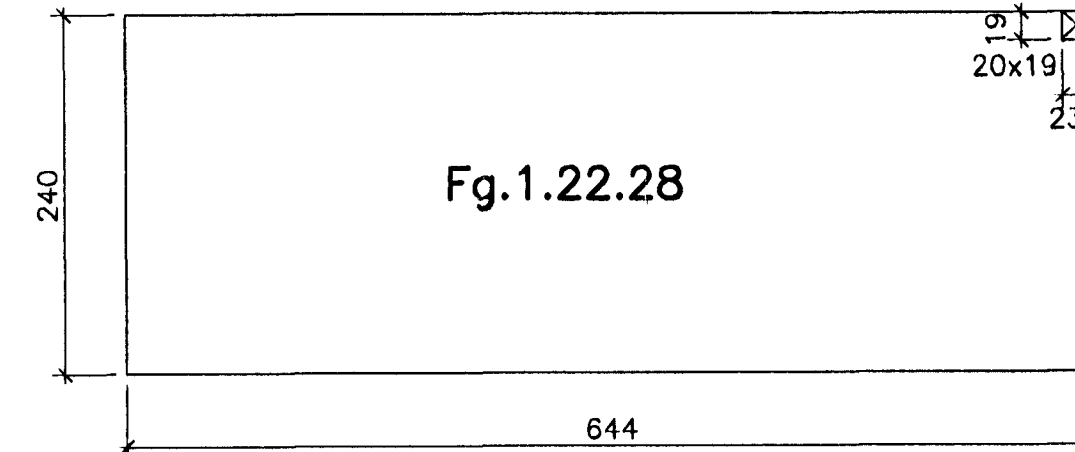
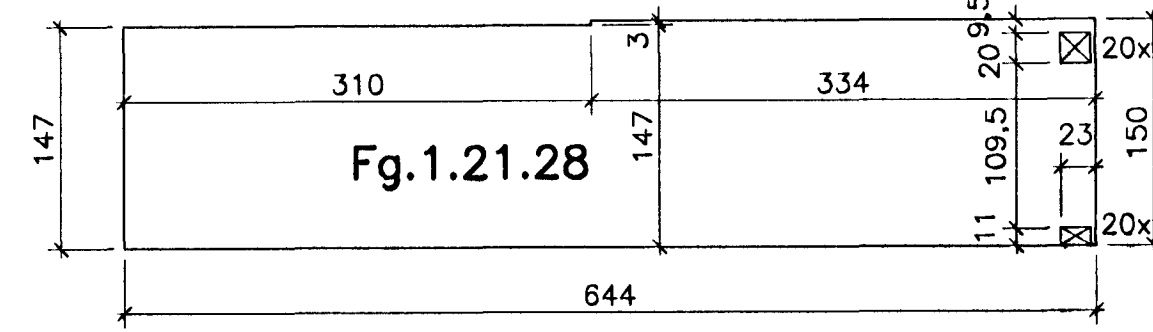
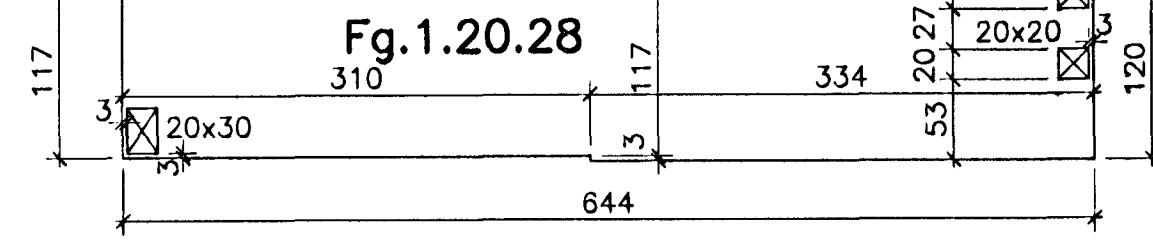
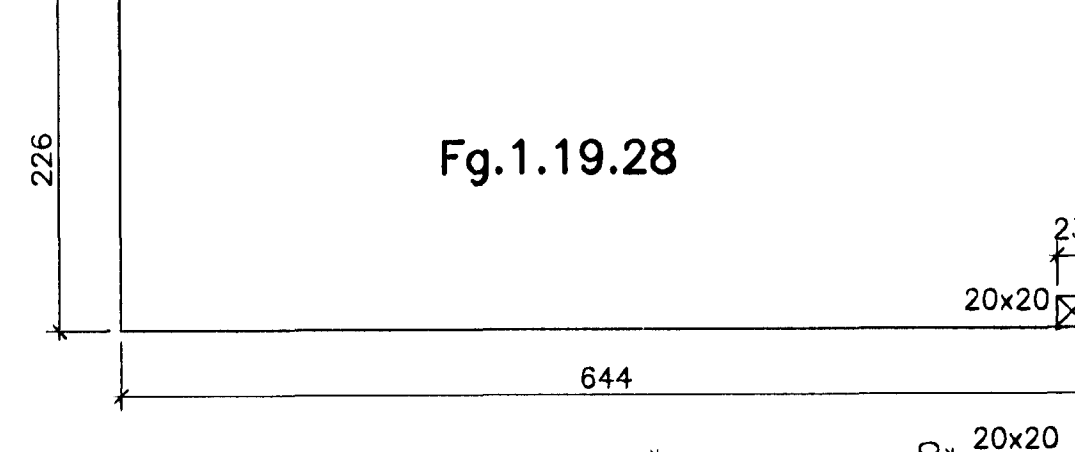
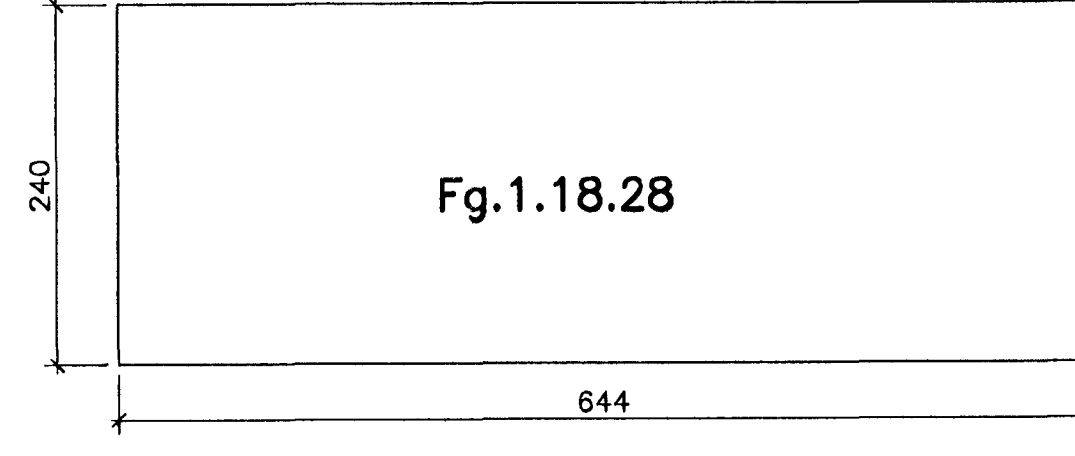
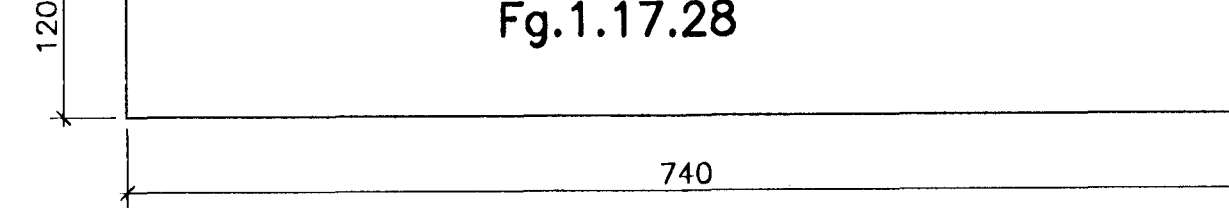
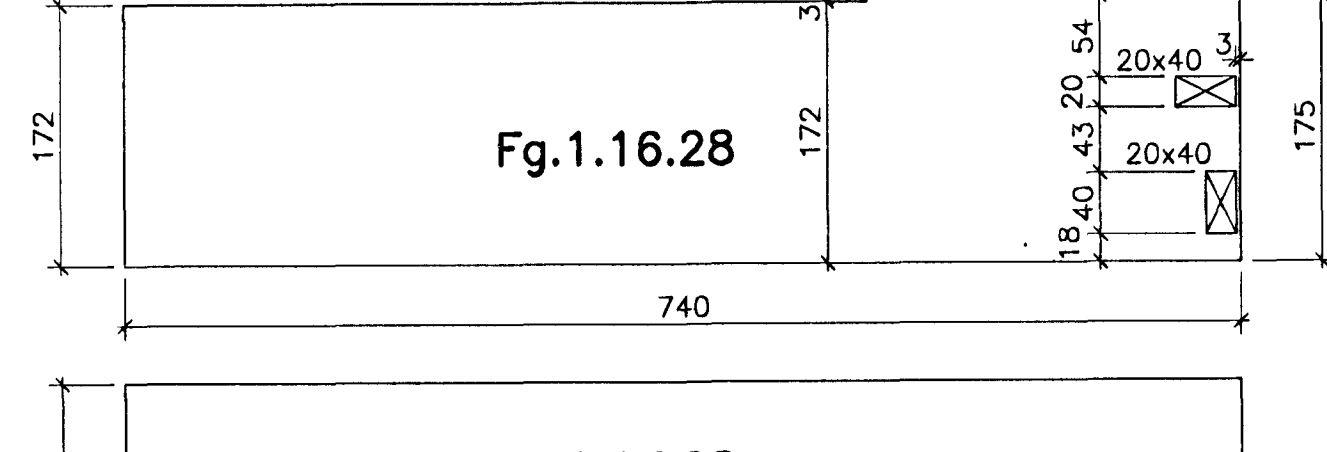
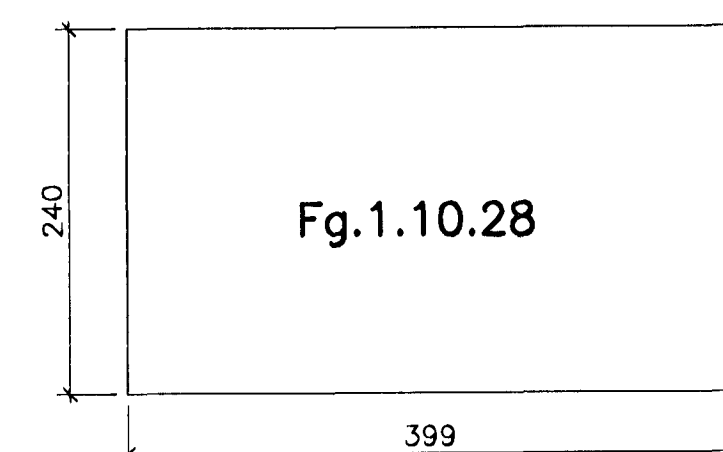
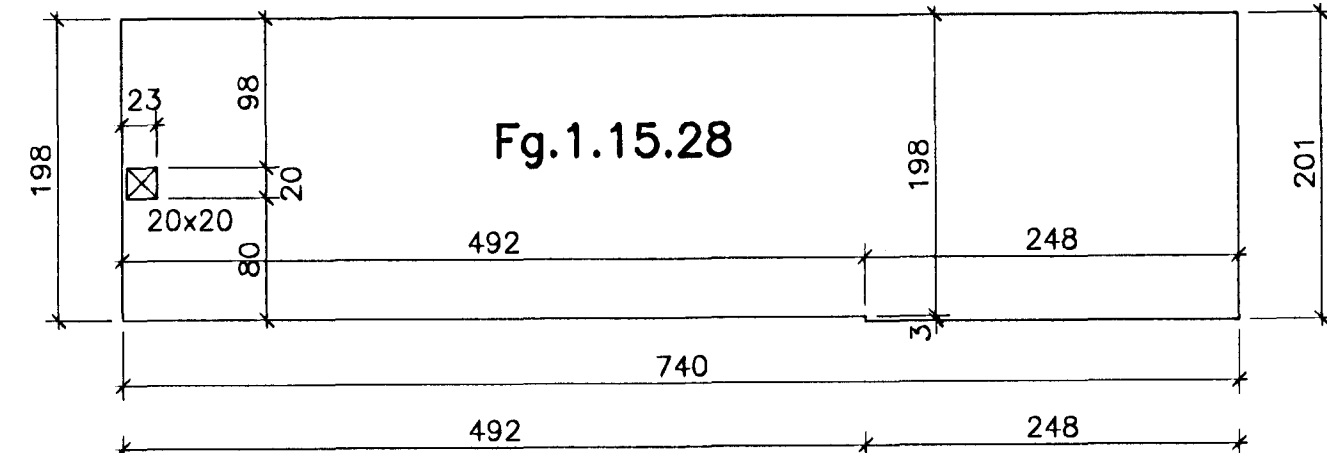
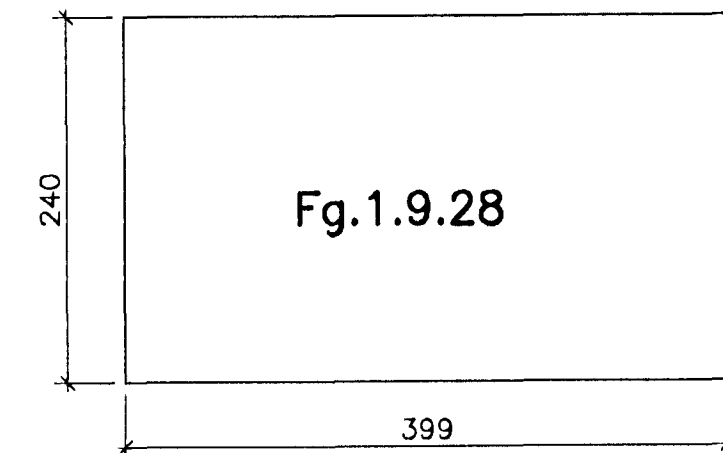
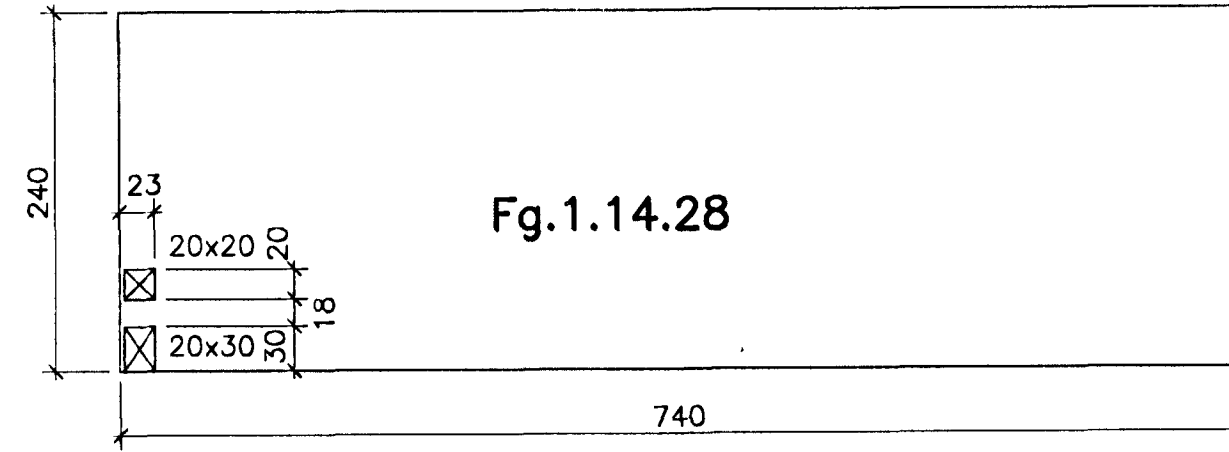
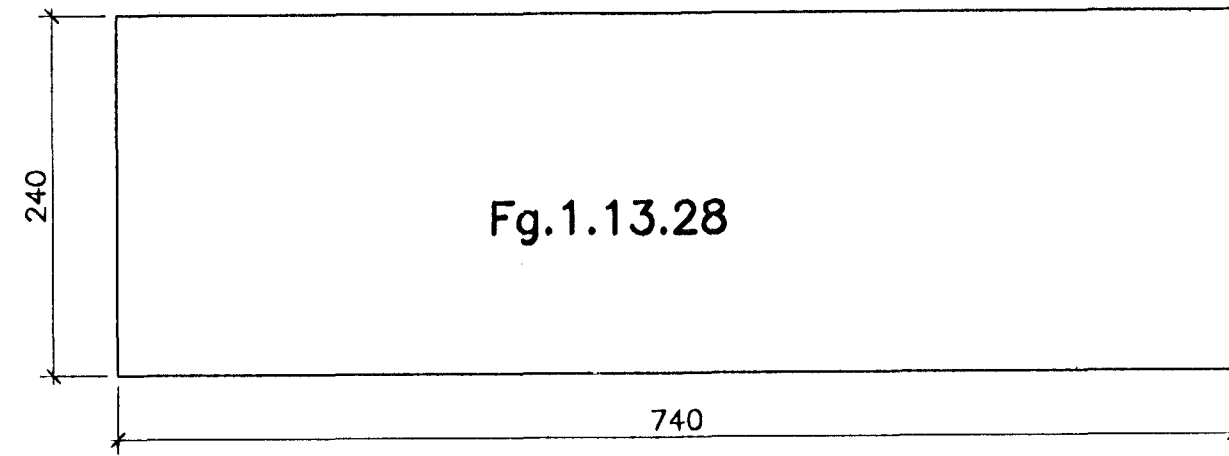

SKÝRINGAR:

Allar loftaplötur eru forsteyptar og forspennar 8 cm þykkar filegranplötur. Tengistigar (filegran-trager) eru 14 cm háir með 90 cm bili. Forspennukaplar eru spennir í 1050 MPa og eru með 30 cm millibili. Sérmynd, sjá bl. 12.

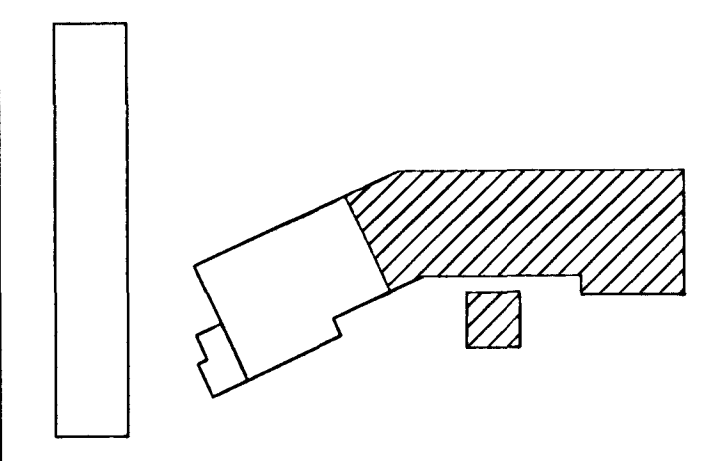

Breytingar:

Samþykkt þann
02 MAÍ 2005
Byggingafræðingur / Hafnarfirði
Fh. Sigurbjartur Halldórsson

TEIKNISTOFAN
ODINSTORGI

Verkefni: Lækjargata 28 Hafnarfirði

Heiti: Järnbent steypa: Forsteyptar loftaplötur (filegranplötur)

Hönnun: Vífill Oddsson verkfræðingur
Nifal Oddsson
101237-3629

VÍFILL ODDSSON VERKFRÆÐINGUR I
kt. 101237-3629 FVFI - FRV
SÍMI: 510-2200
ÓDINSGÖTU 7 REYKJAVÍK FAX: 510-2201

M. 1:50
R. V.O./K.S.G.
T. K.S.G.
Dags. feb. 2005 Nr. 968-1-10