

JÄRNBENT STEYPA

Forsteyptar loftaplötur (filegran)

Yfirlitsmynd 1:50

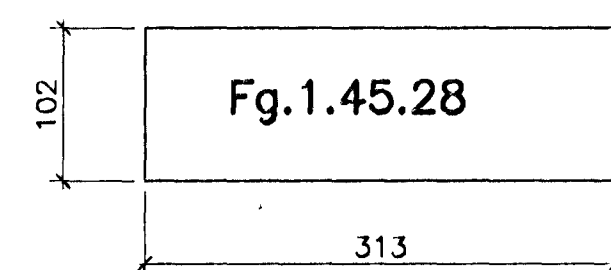
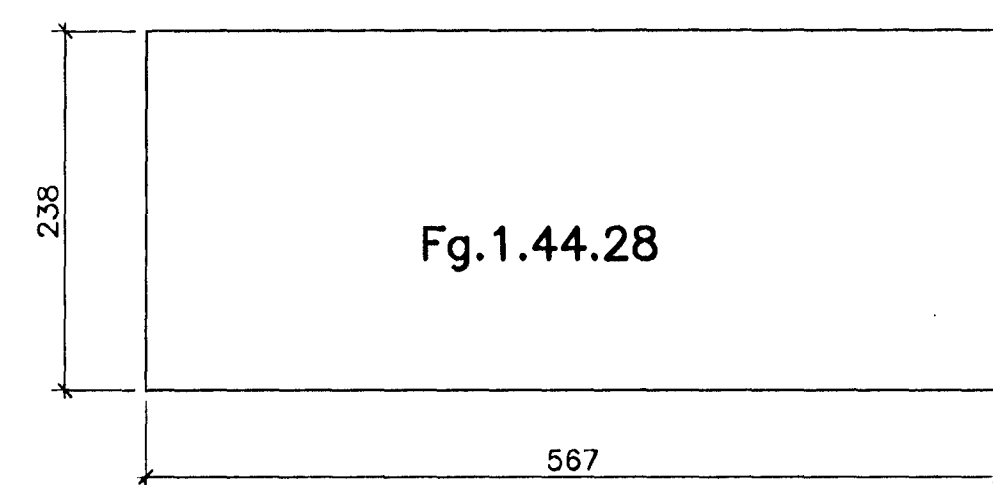
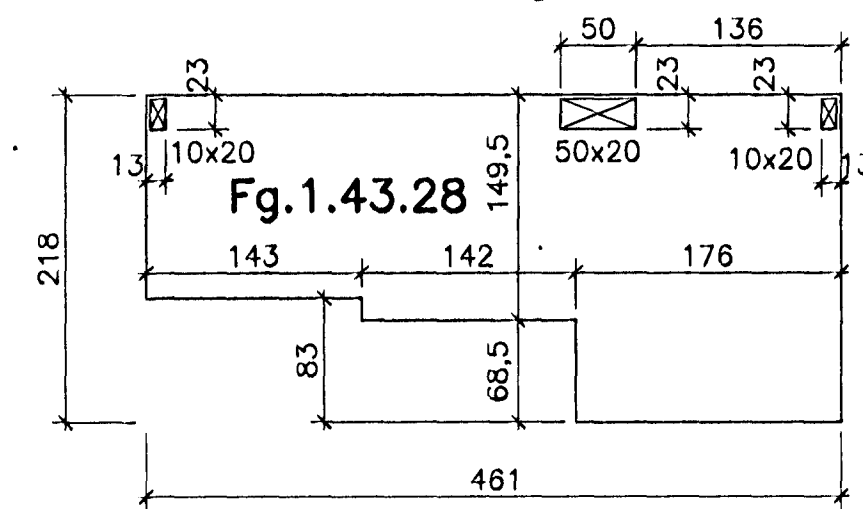
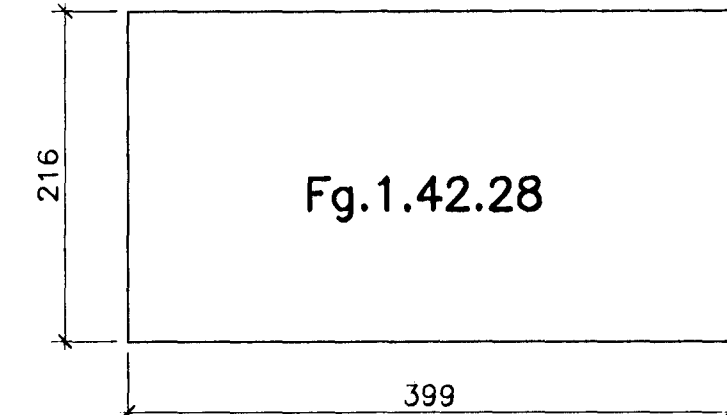
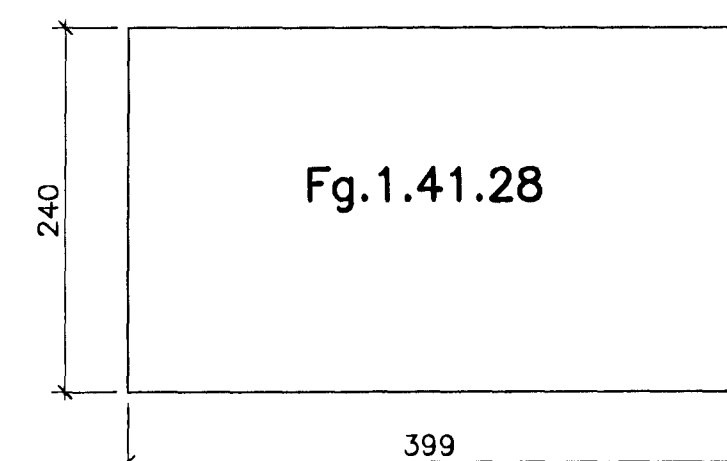
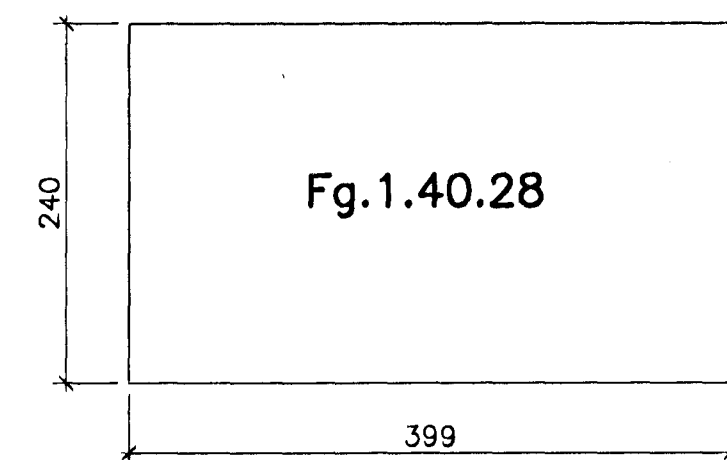
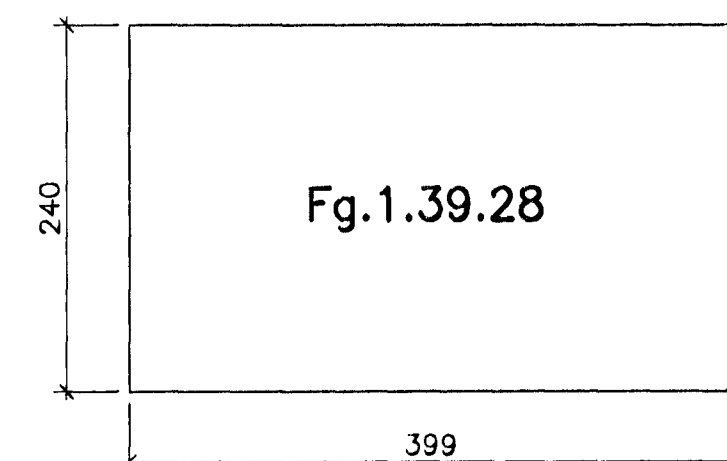
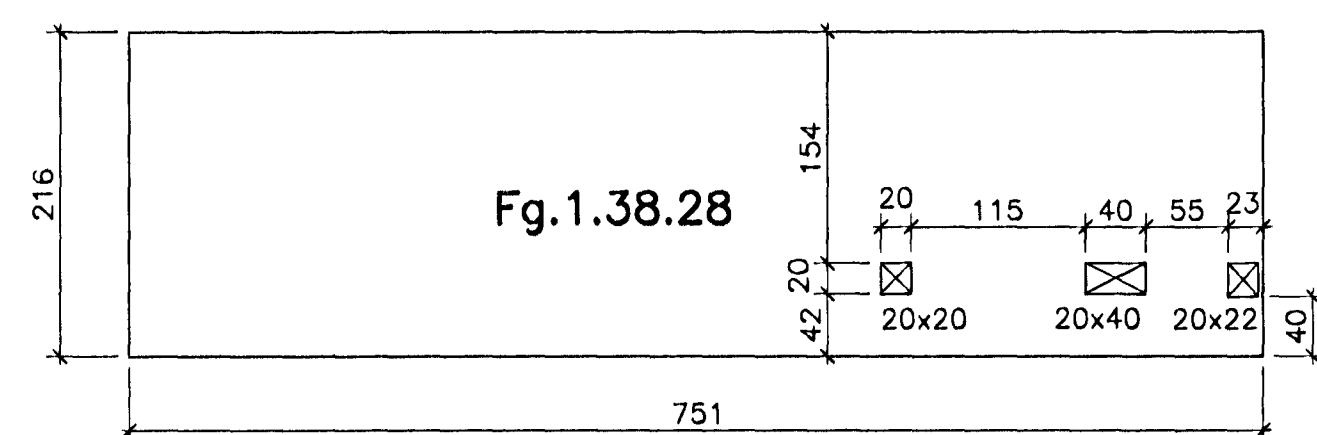
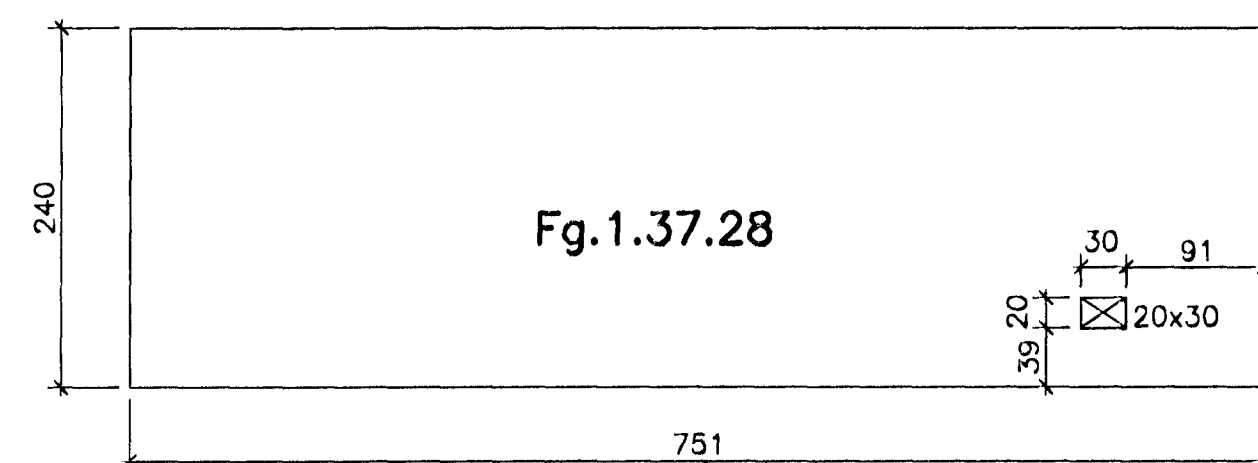
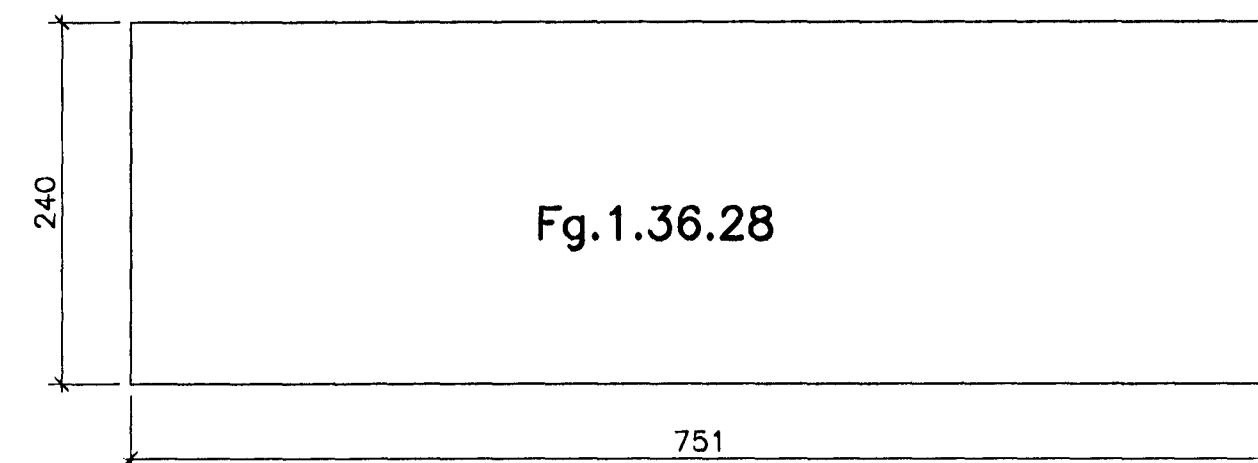
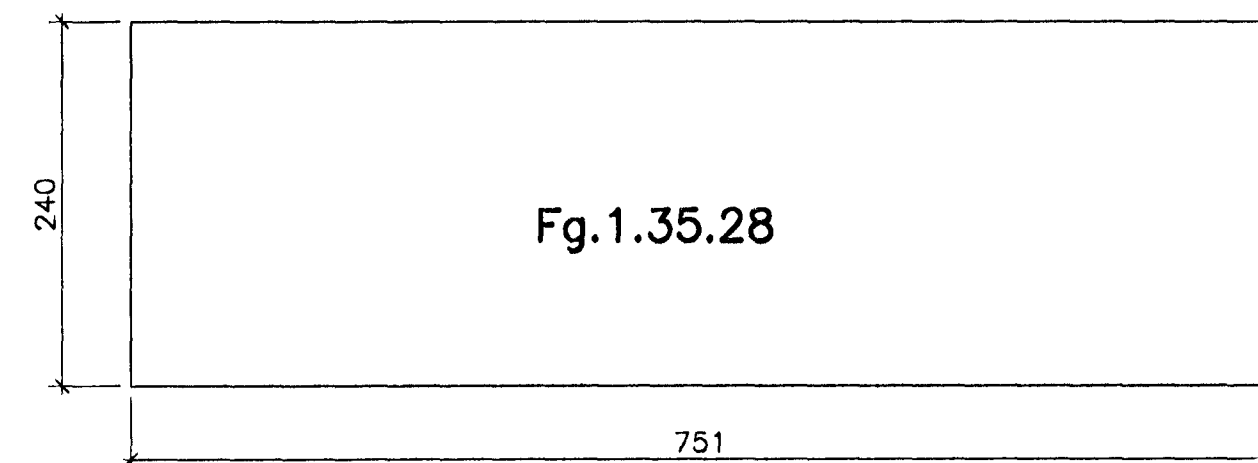

SKÝRINGAR:

Allar loftaplötur eru forsteyptar og forspennar 8 cm bykkar filegranplötur. Tengistigar (filegran-trager) eru 14 cm háir með 90 cm bili. Forspennukaplar eru spennir í 1050 MPa og eru með 30 cm millibili. Sérmynd, sjá bl. 12.

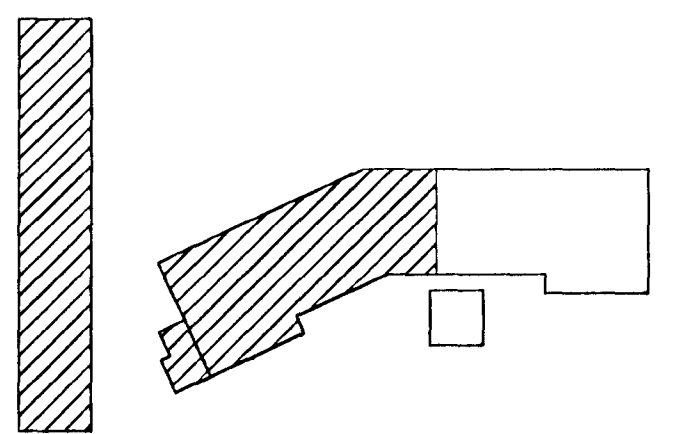
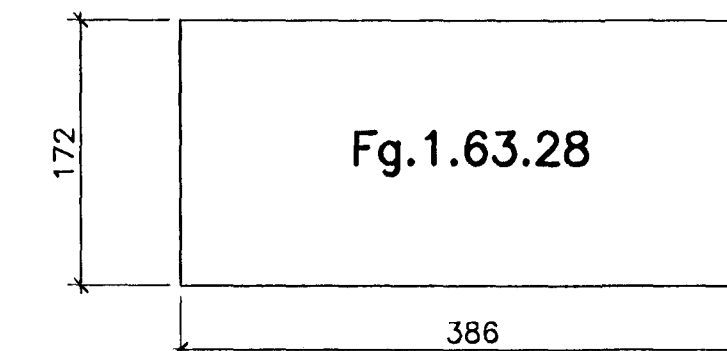
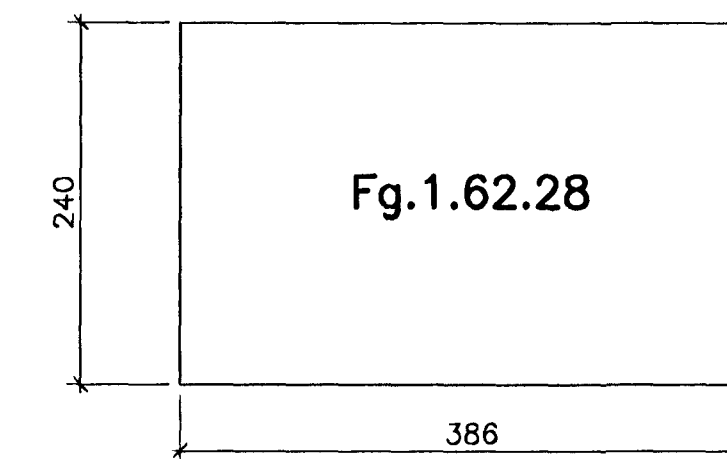
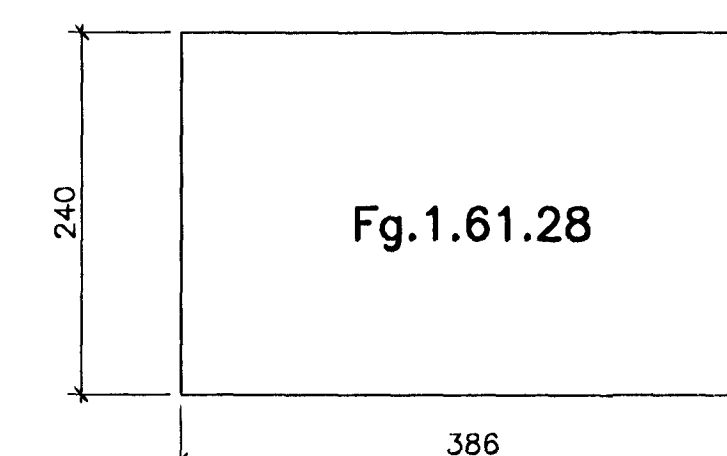
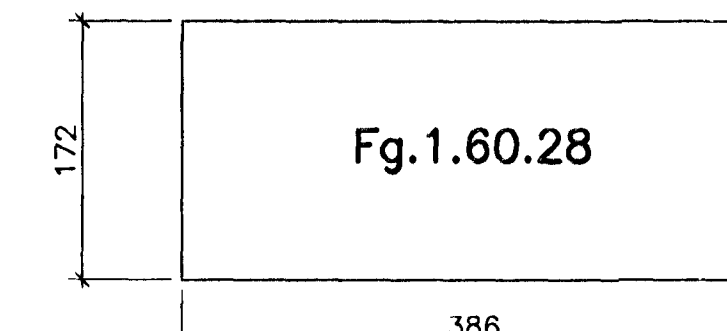
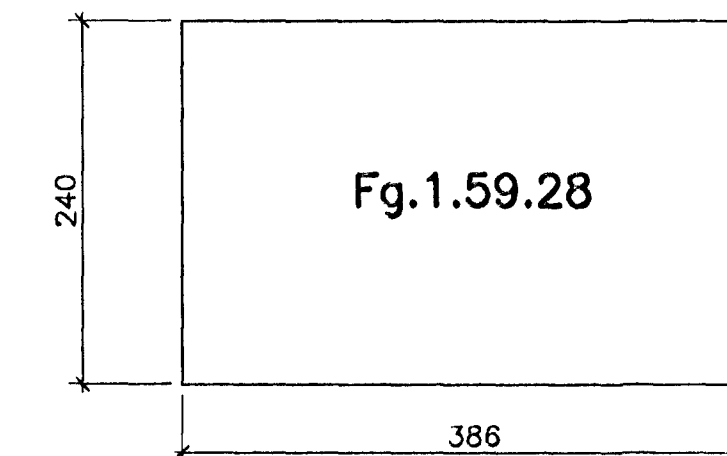
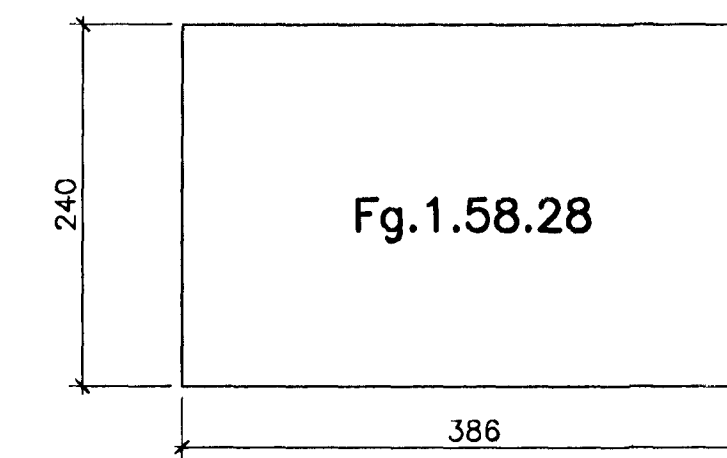
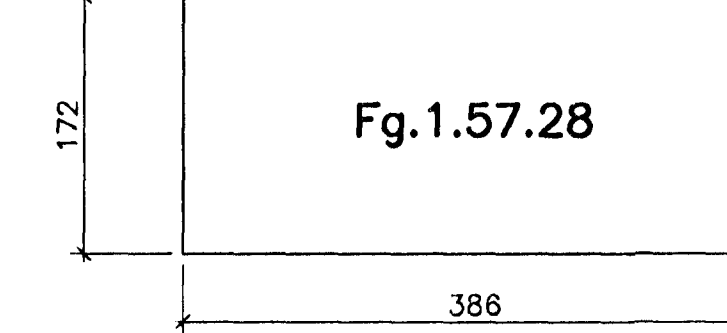
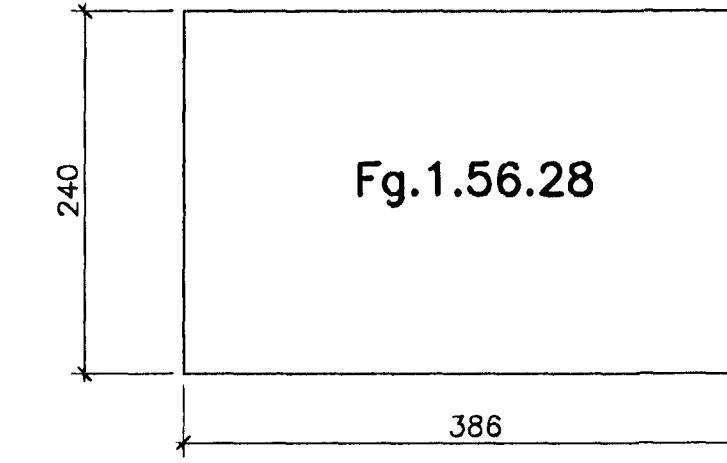
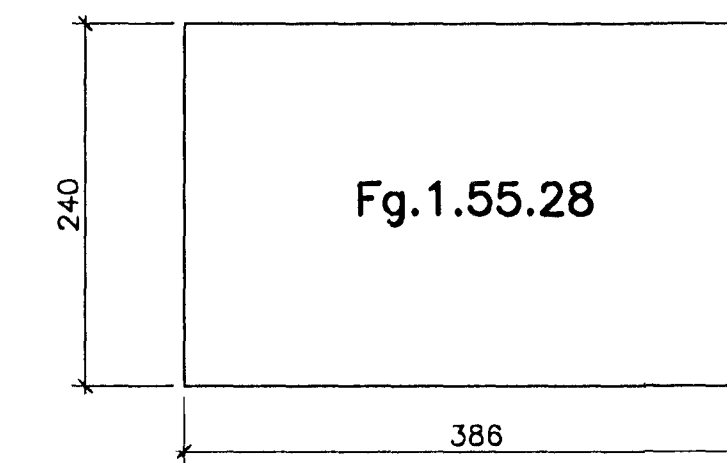
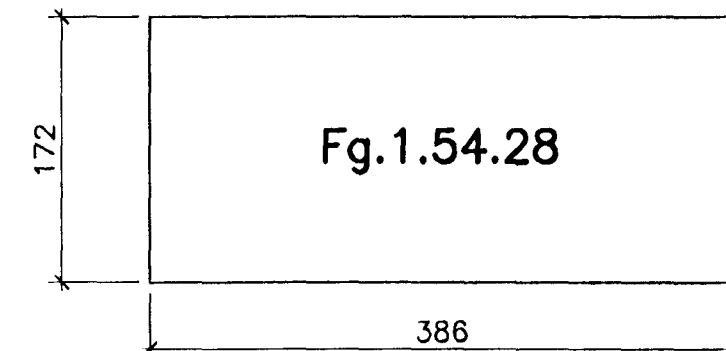
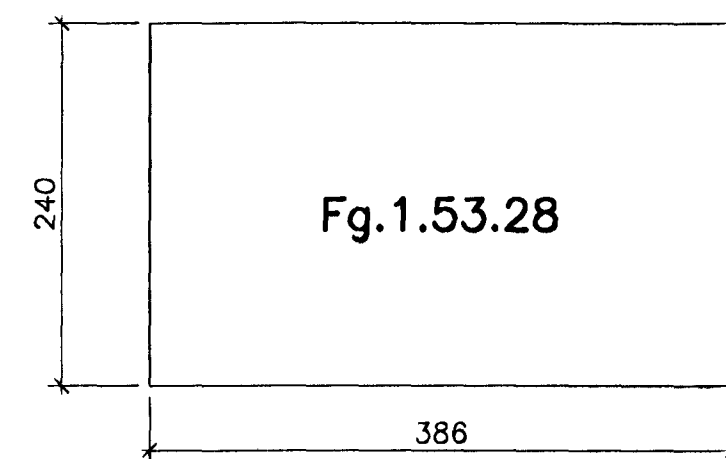
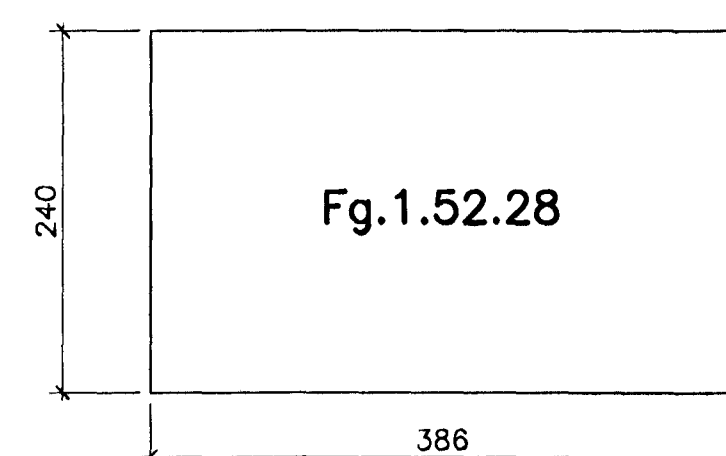
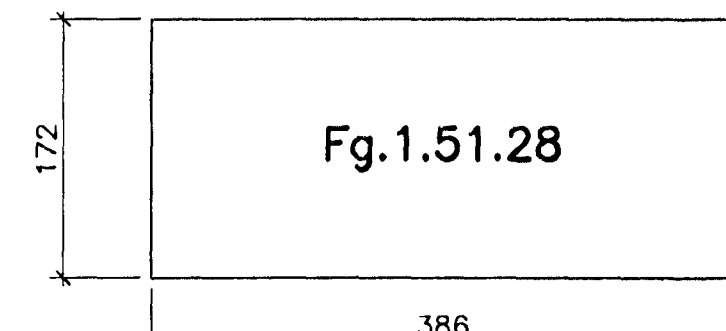
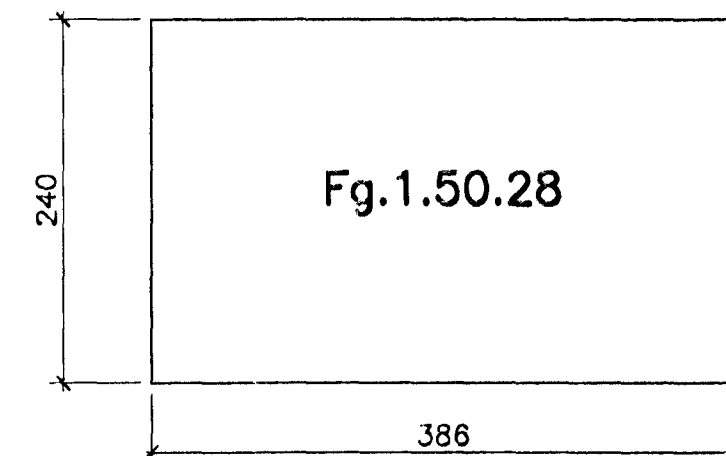
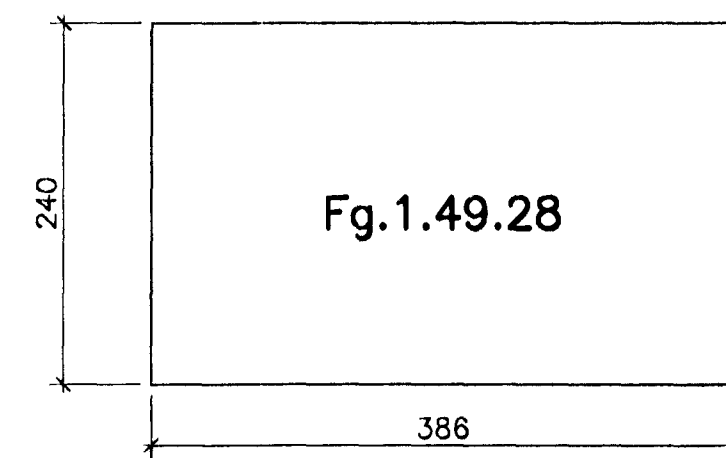
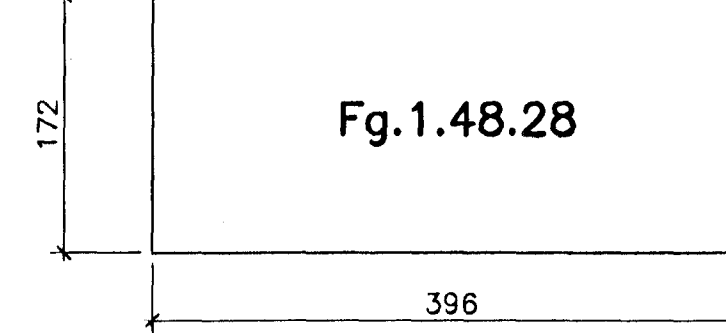
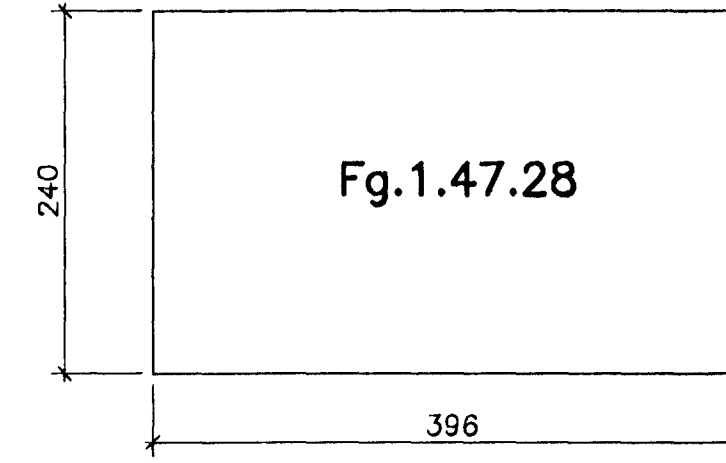
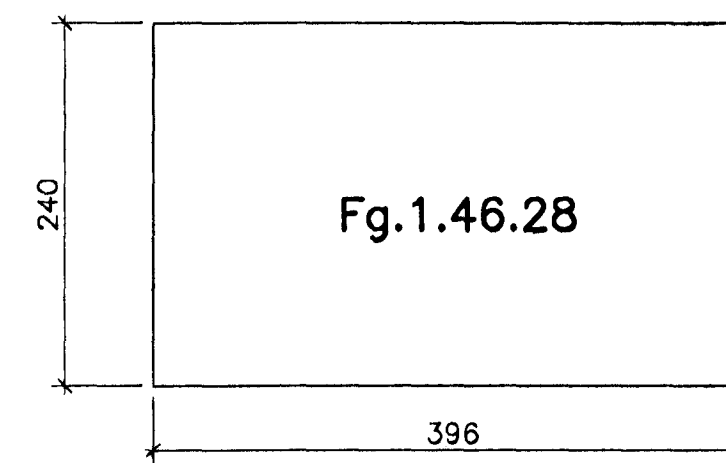

Breytingar:

Samþykkt þann

02 MAI 2005

Byggingafulltrúinn í Hafnarfirði
F.h. Sigurbjartur Hallgrímsson

TEIKNISTOFAN
ÓDINSTORGI

Verkefni: Lækjargata 28 Hafnarfirði

Heiti: Järnbent steypa: Forsteyptar loftaplötur (filegranplötur)

Hönnun: Vífill Oddsson verkfræðingur

Vífill Oddsson
1012 37 3629

VÍFILL ODDSSON VERKFRÆÐINGUR
kt. 101237-3629 FVFI - FRV
SIMI: 510-2200
ÓDINGGÖTU 7 REYKJAVÍK FAX: 510-2201

M. 1:50
R. V.O./K.S.G.
T. K.S.G.
Dags. feb. 2005 Nr. 968-1-11