

JÄRNBENT STEYPA

Forsteyptar loftaplötur (filegran) yfir 2. og 3. hæð

Yfirlitsmynd 1:50

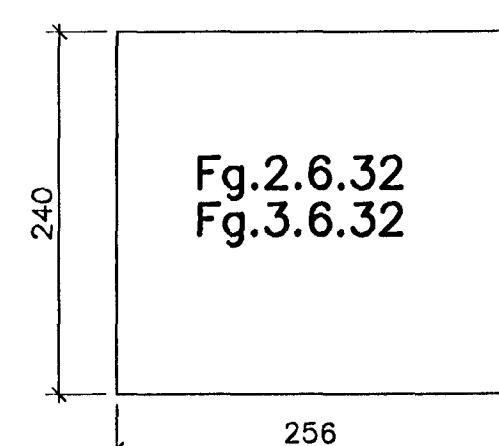
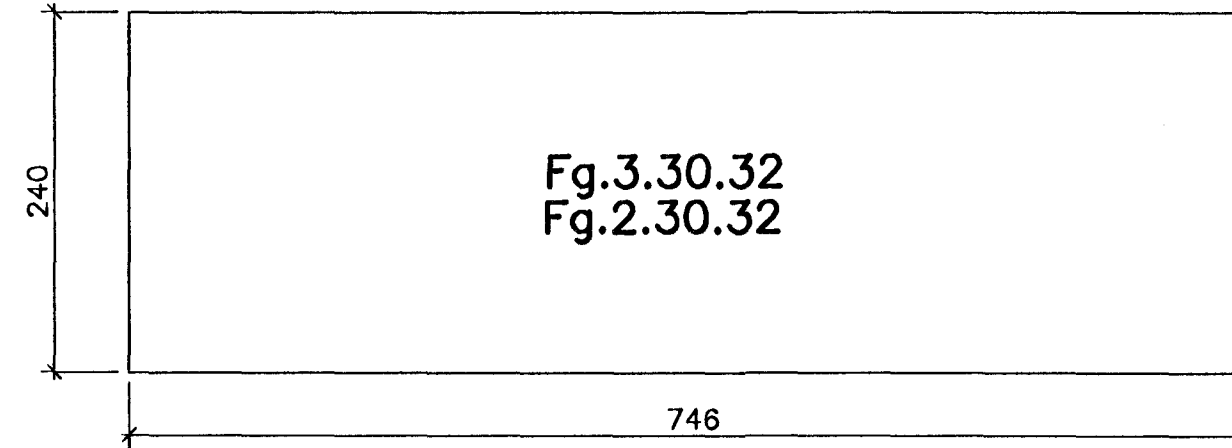
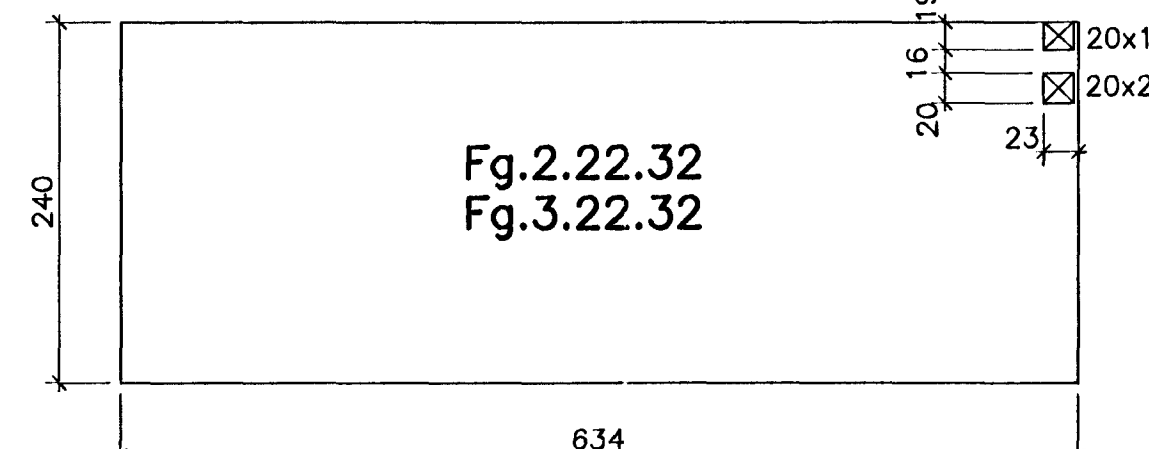
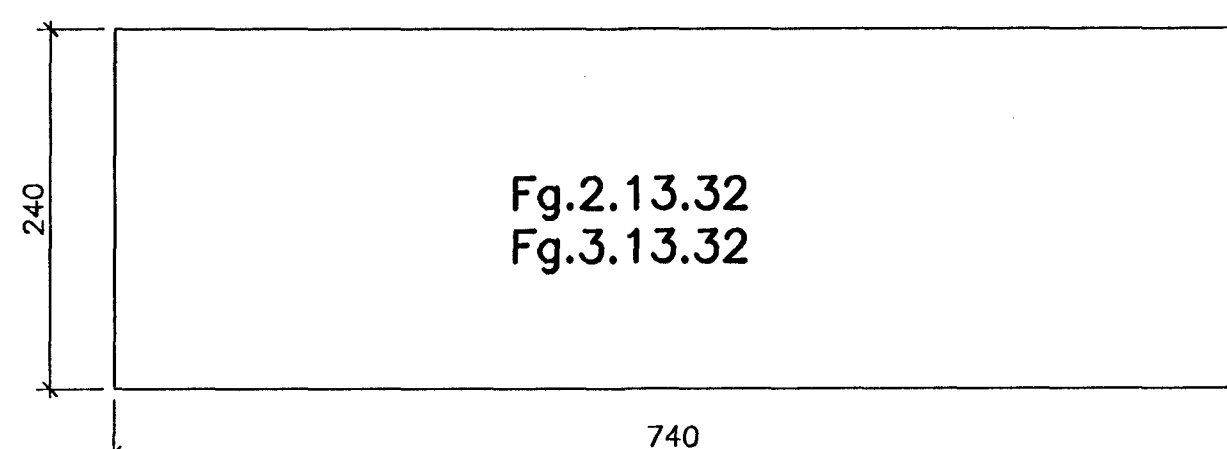
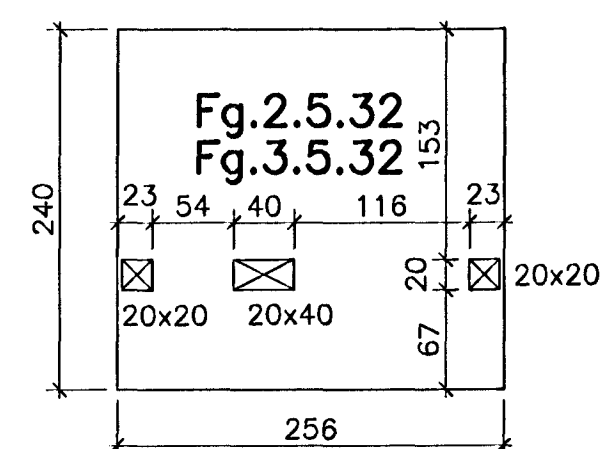
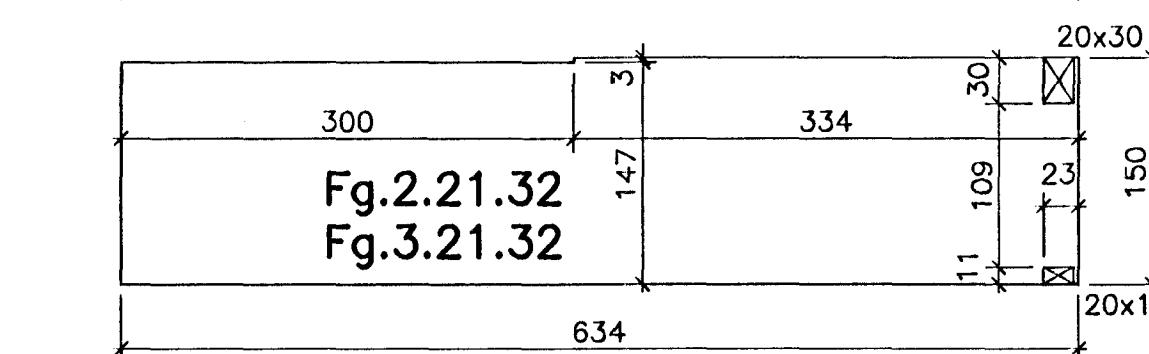
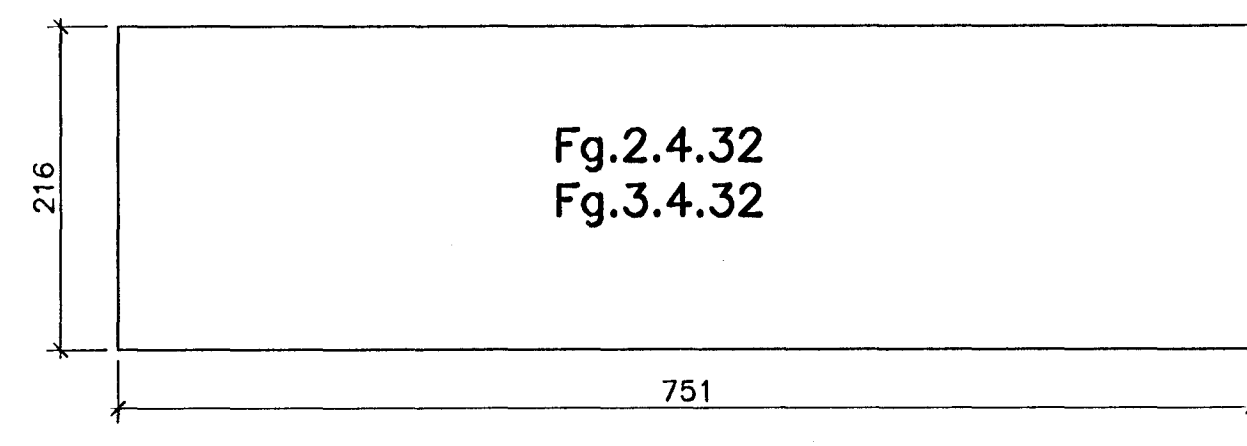
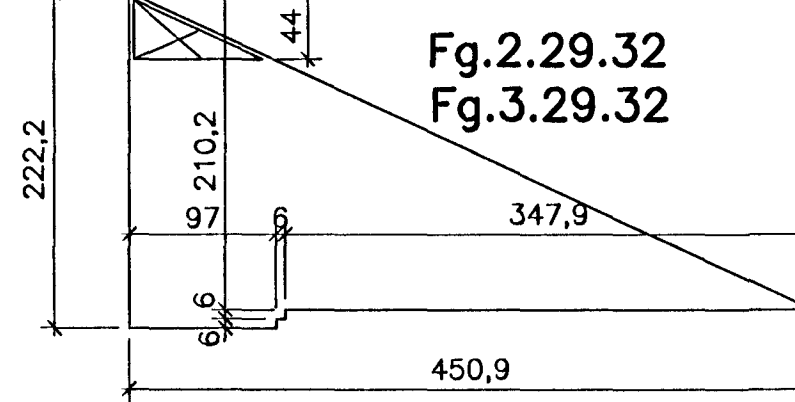
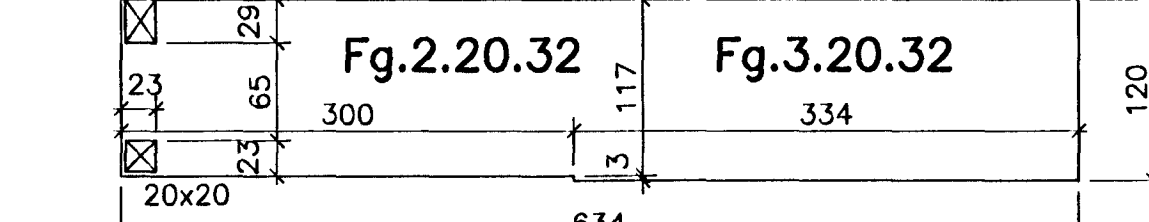
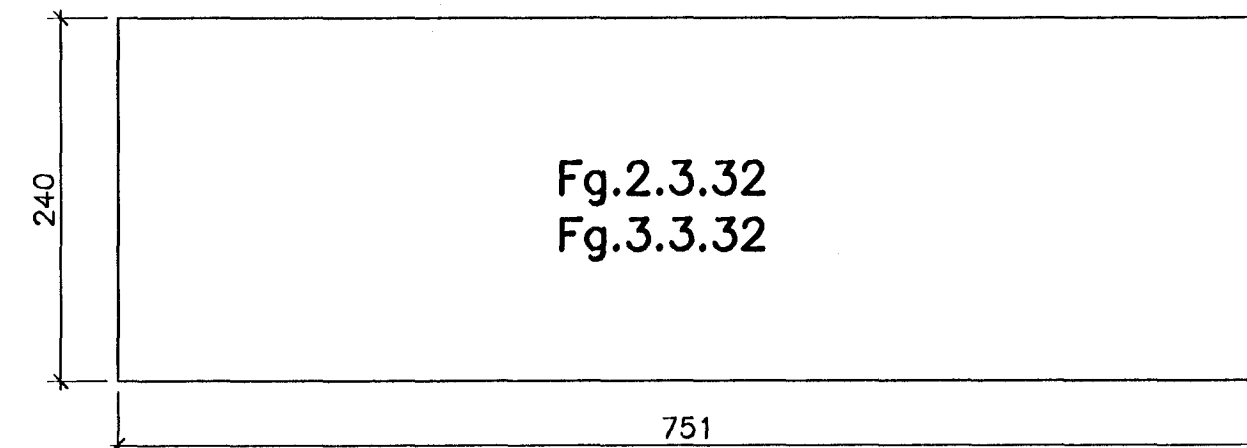
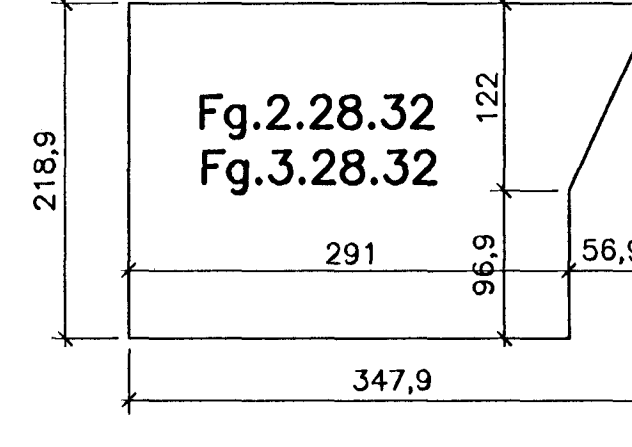
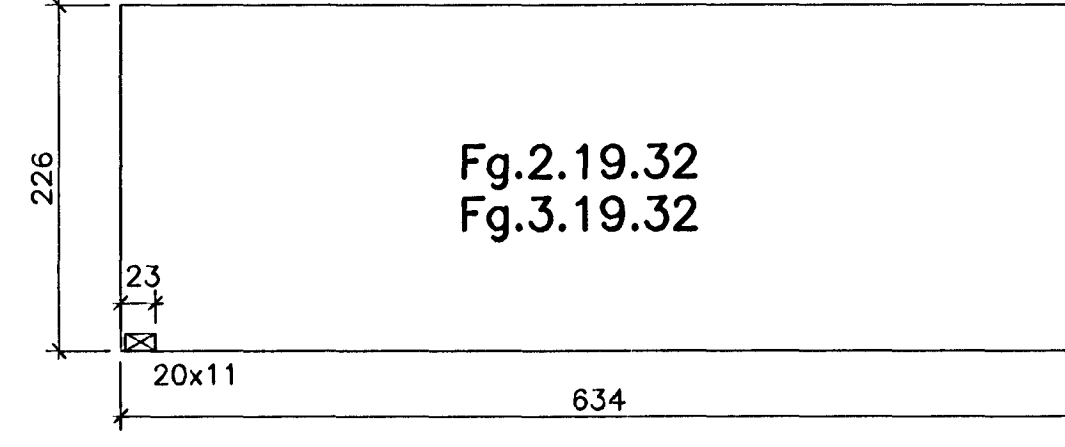
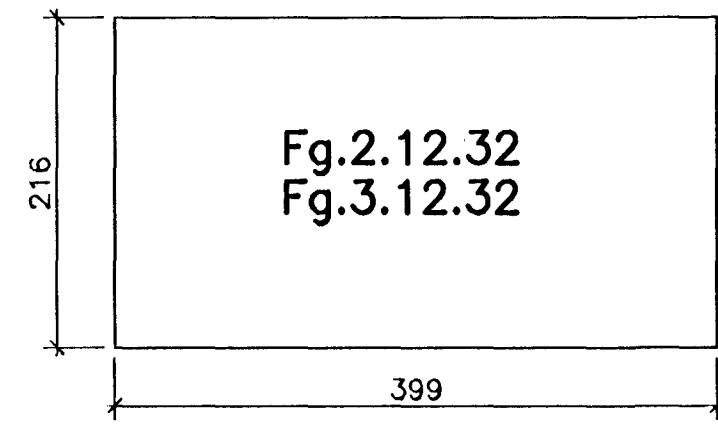
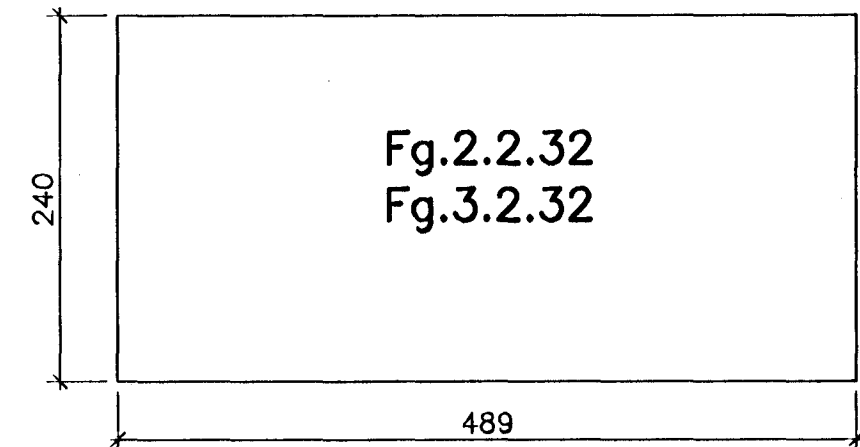
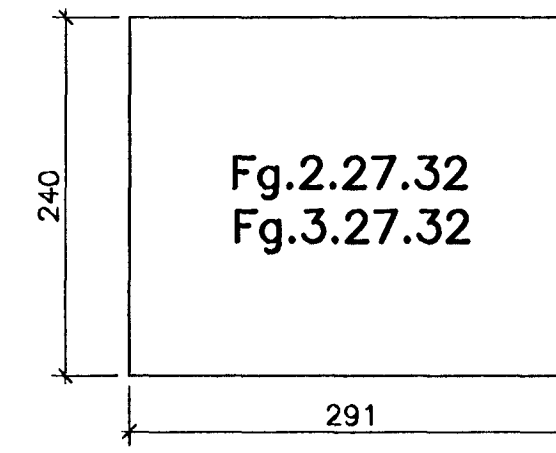
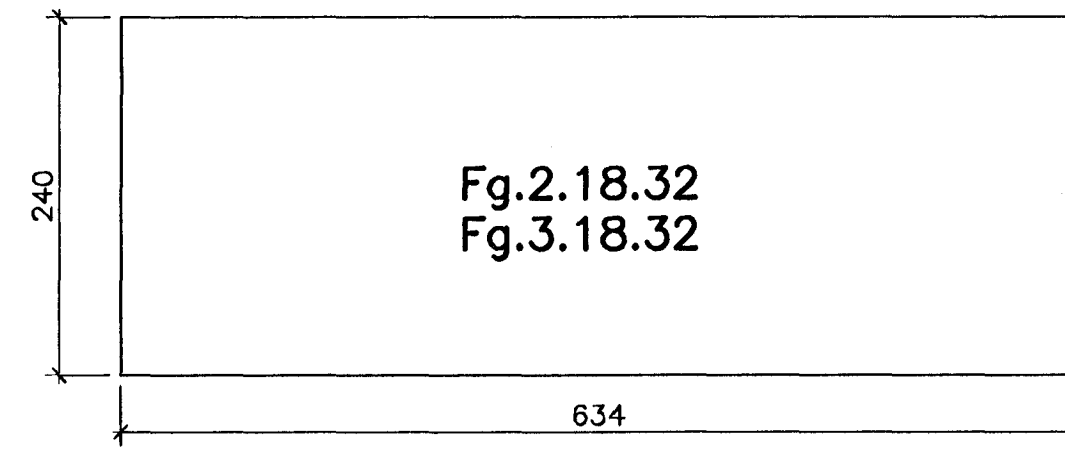
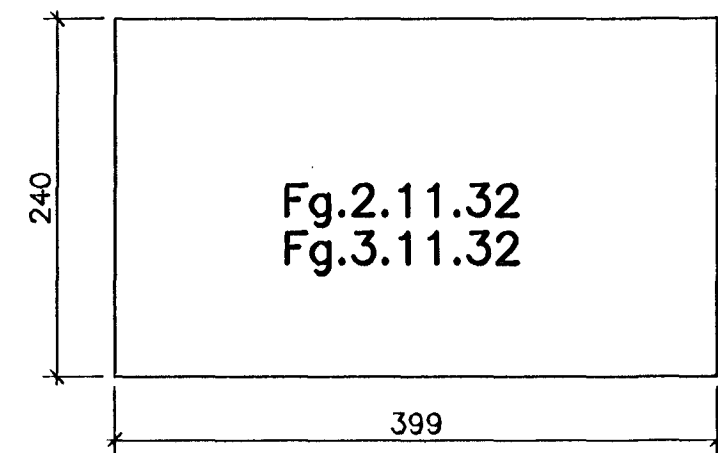
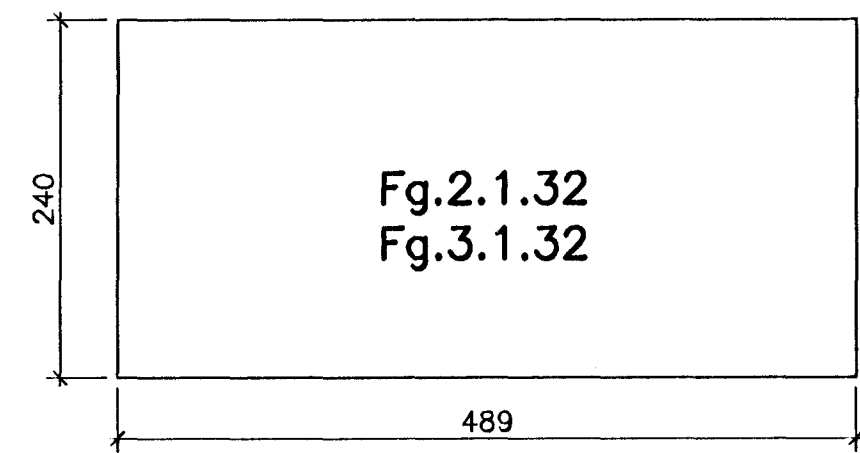

Fg.3.7.32 ekki til
Fg.2.7.32 ekki til
Fg.3.8.32 ekki til
Fg.2.8.32 ekki til

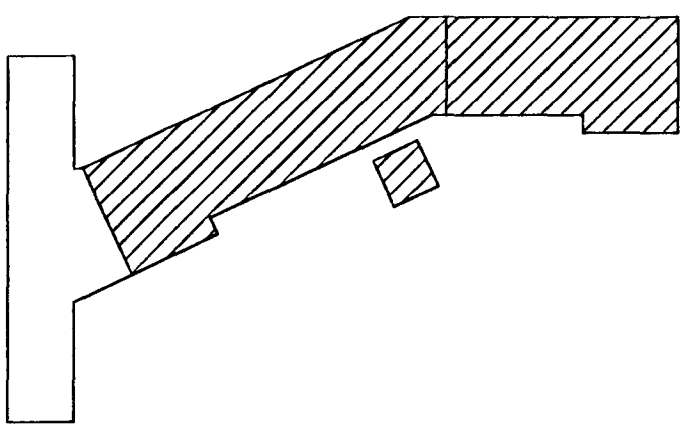
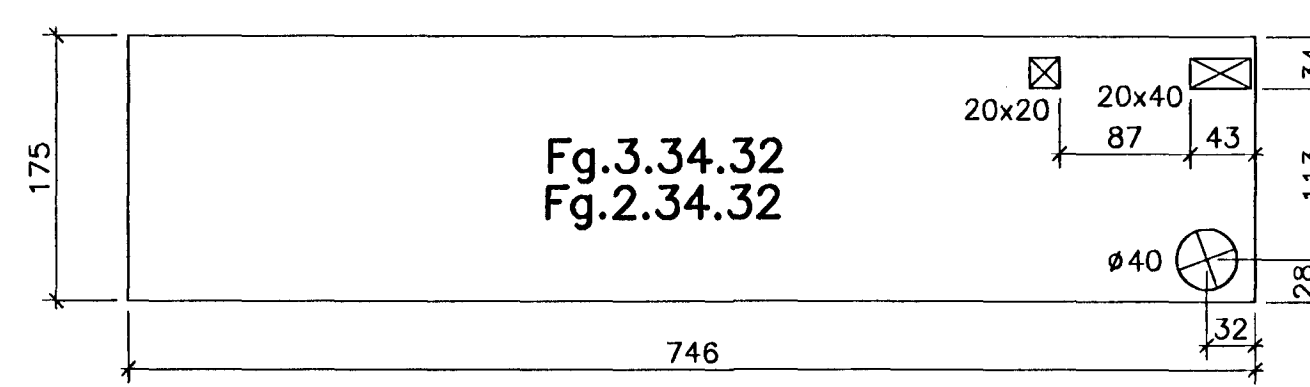
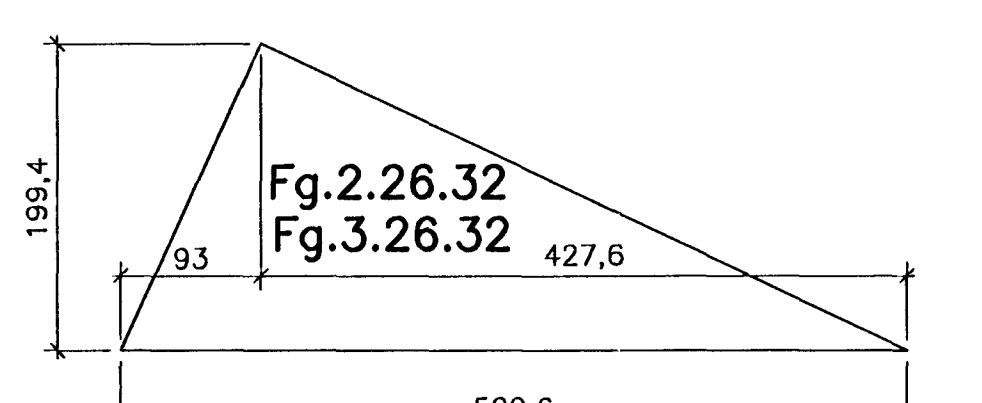
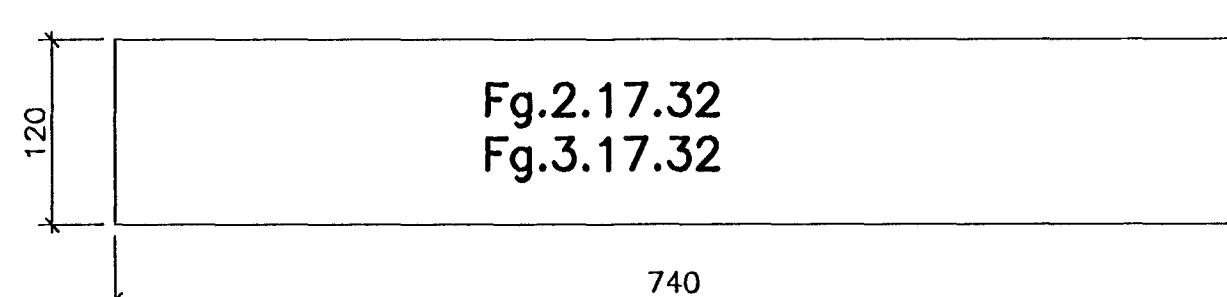
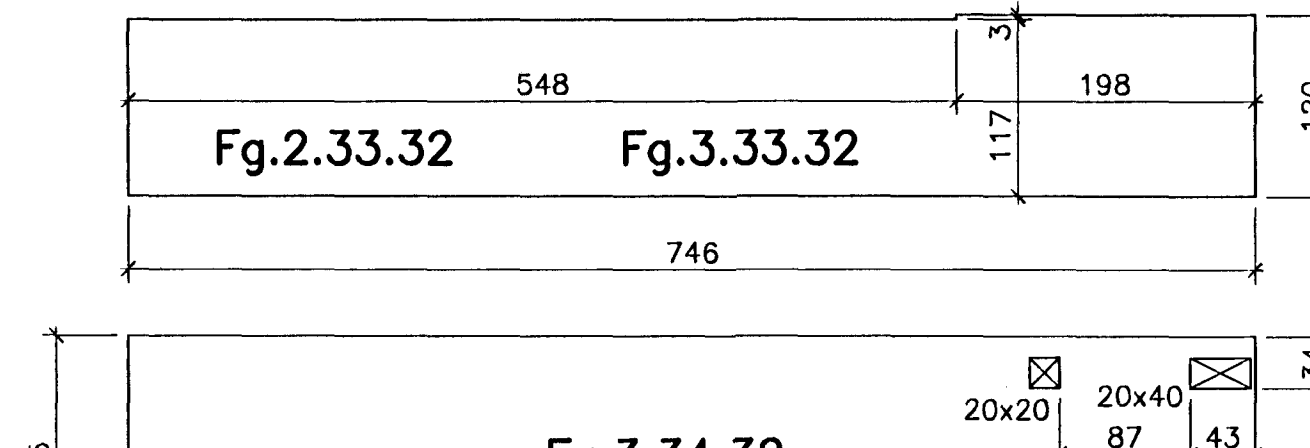
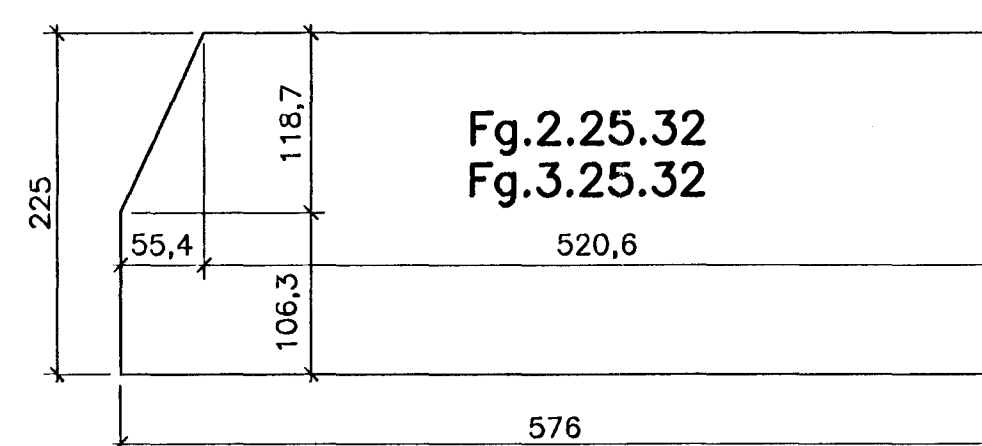
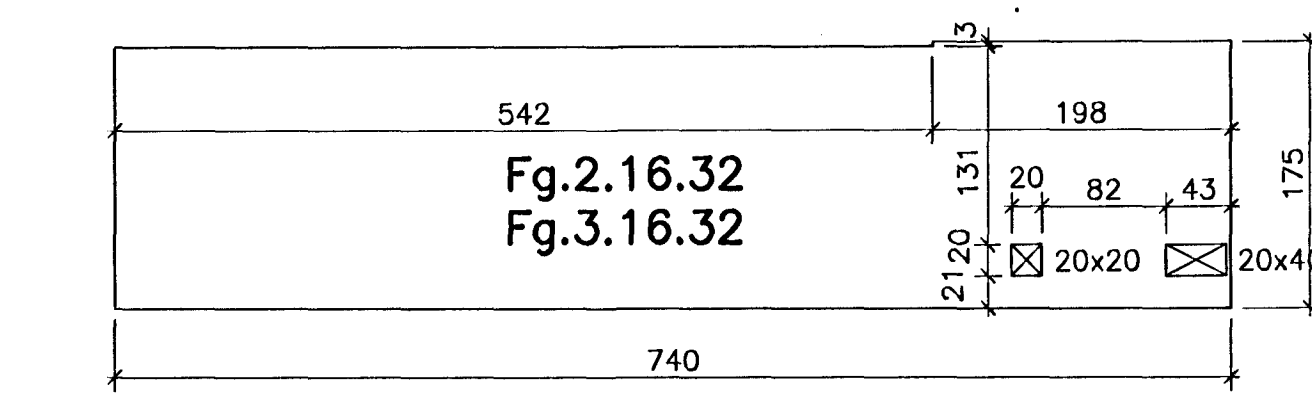
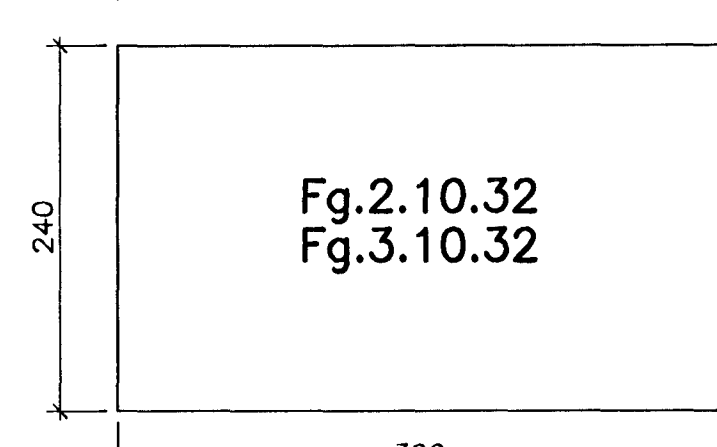
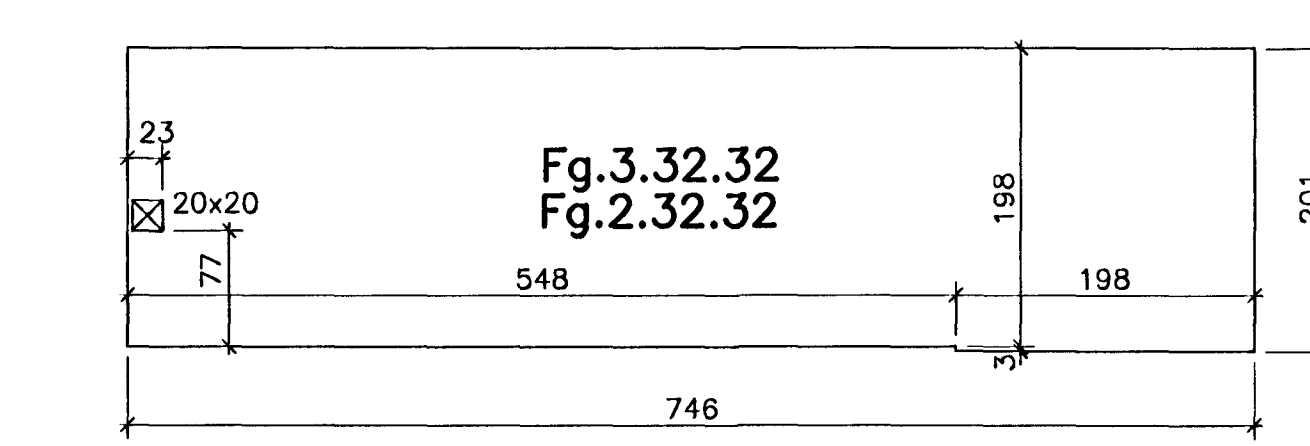
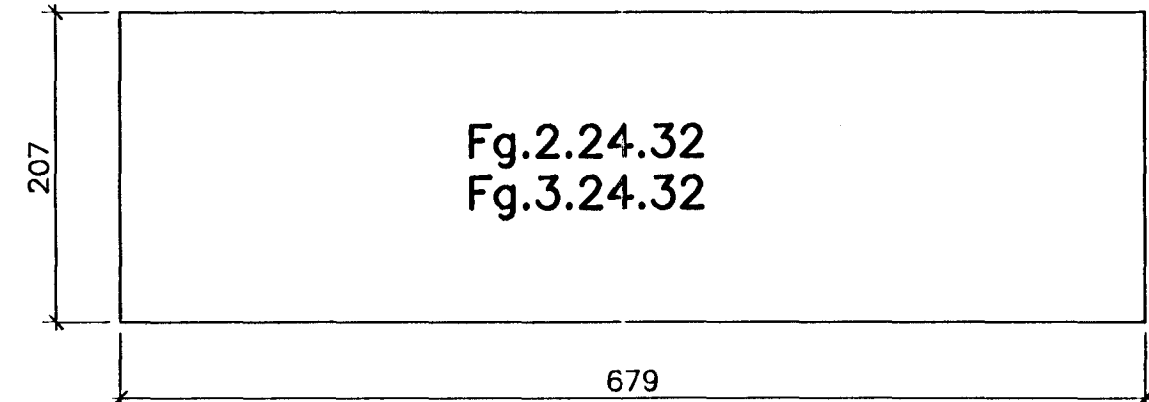
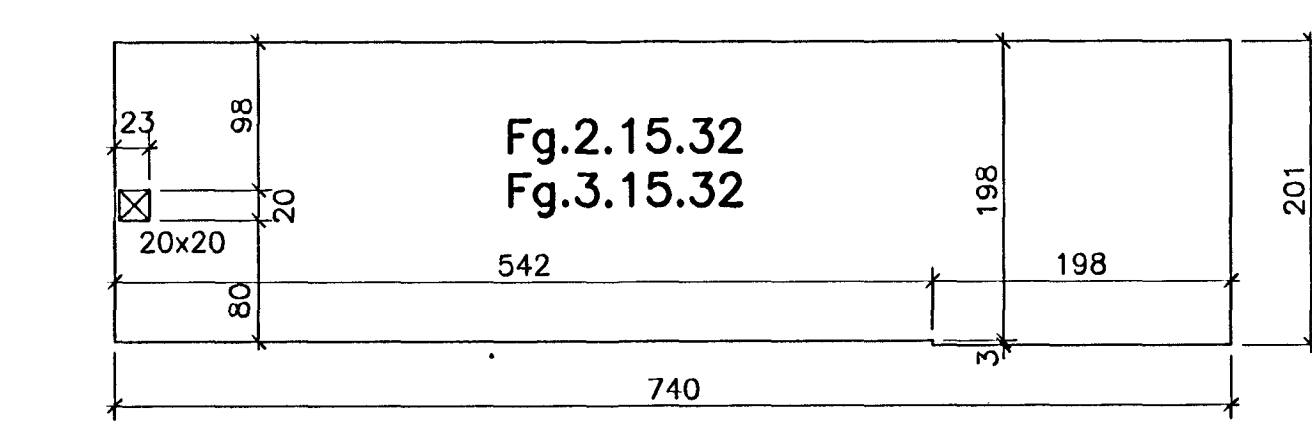
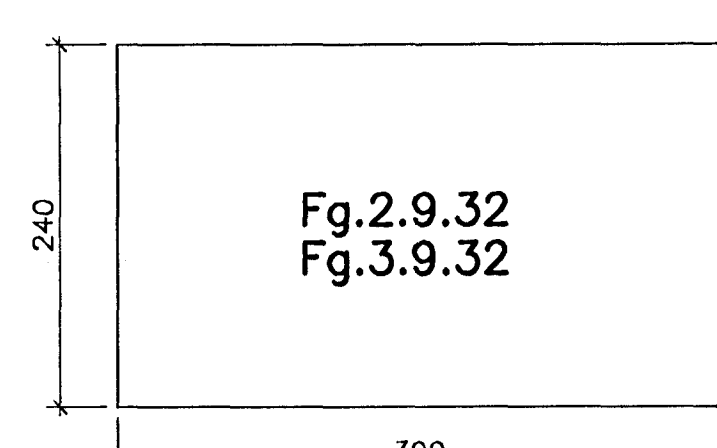
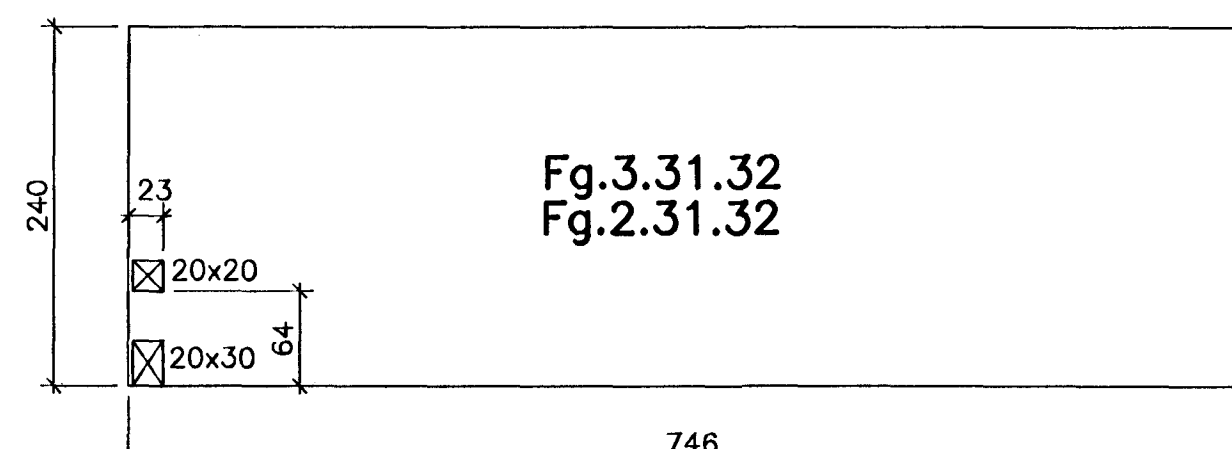
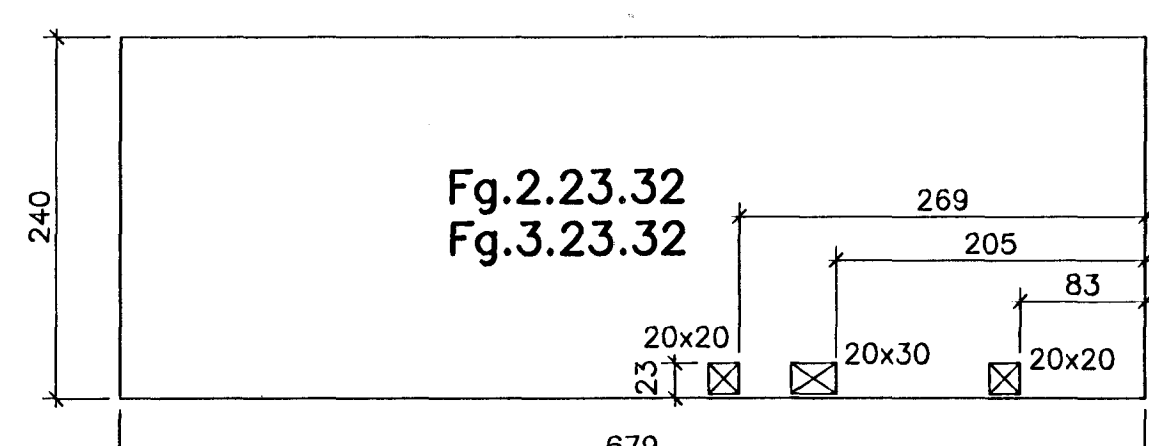
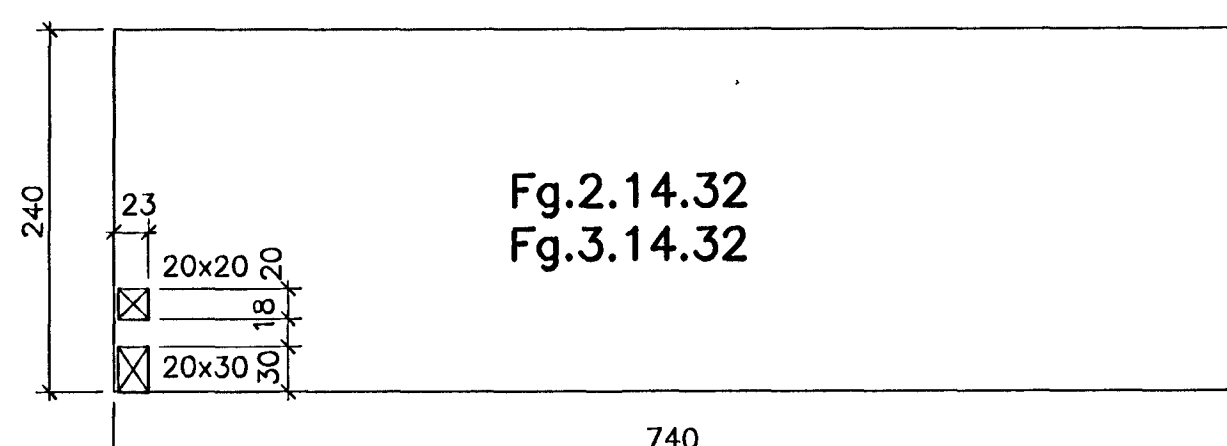

Breytingar:

SKÝRINGAR:

Allar loftaplötur eru forsteyptar og forspennnar 8 cm bykkar filegranplötur. Tengistigar (filegran-trager) eru 14 cm háir með 90 cm bili. Forspennukaplar eru spennir í 1050 MPa og eru með 30 cm millibili. Sérmynd, sjá bl. 53.

Sifissel Oddsson
101237-3629

TEIKNISTOFAN ODINSTORGI Samþykkt þannir
07 MARS 2005
Byggingafrádráttur í Hafnarfirði
Fb. Sigurbjartur Halldórsson

Verkefni: Lækjargata 32 Hafnarfirði
Heiti: Járnhent steypa: Forsteyptar loftaplötur yfir 2. og 3. hæð
Hönnun: Vífill Oddsson verkfræðingur

VÍFILL ODDSSON VERKFRÆÐINGUR
kt. 101237-3629 FVFI - FRV
ÓDINGSGÖTU 7 REYKJAVÍK SÍMI: 510-2200
FAX: 510-2201

M. 1:50
R. V.O./K.S.G.
T. K.S.G.
Dags. des. 2004 Nr. 970-1-52