

# JARBENT STEYPA Forsteyptar loftaplötur (filegran) yfir 2. og 3. hæð Yfirlitsmynd 1:50

Fg.3.35.32 ekki til  
Fg.2.35.32 ekki til  
Fg.3.36.32 ekki til  
Fg.2.36.32 ekki til

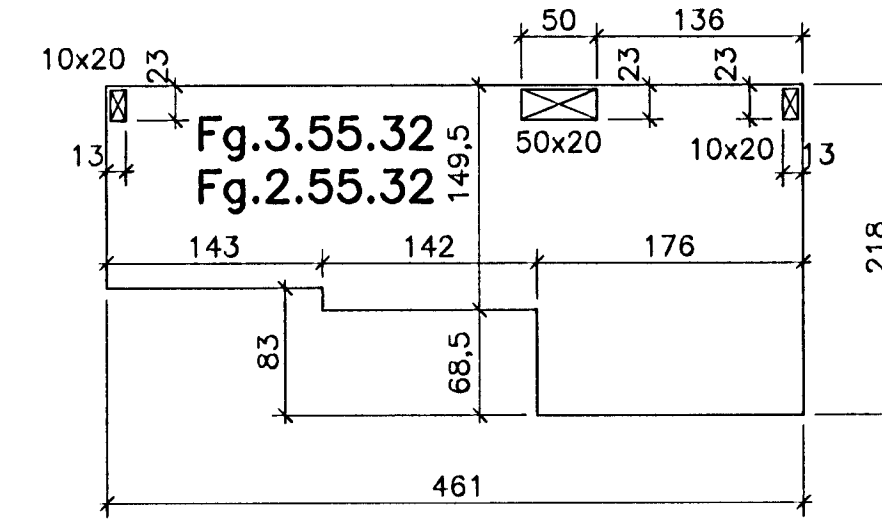
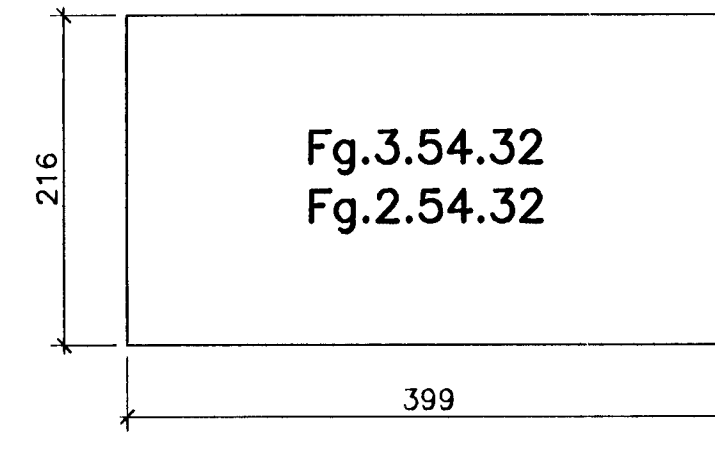
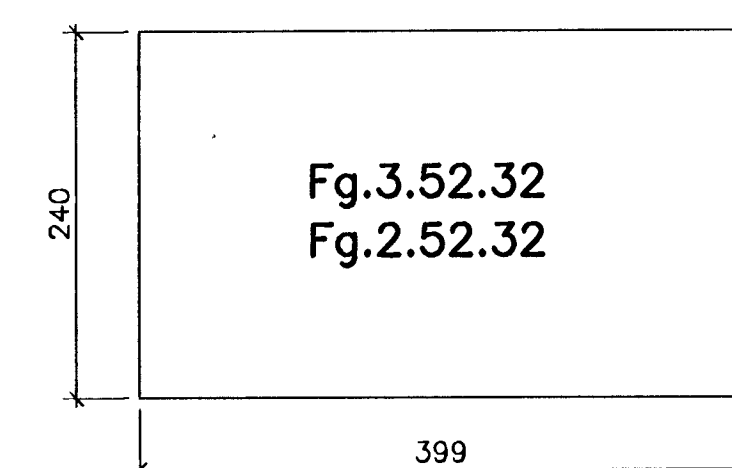
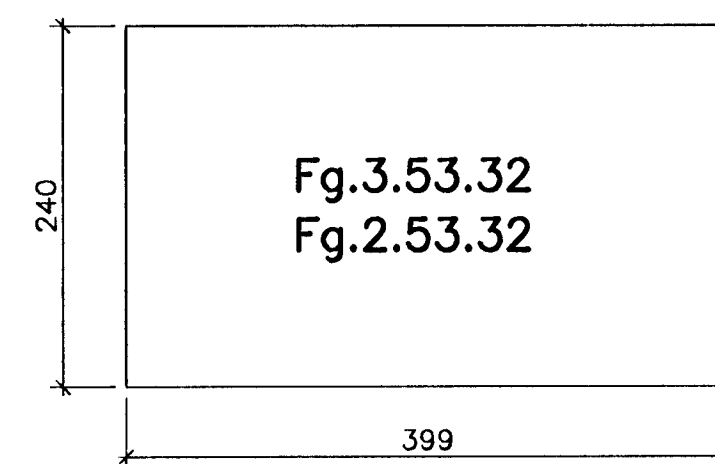
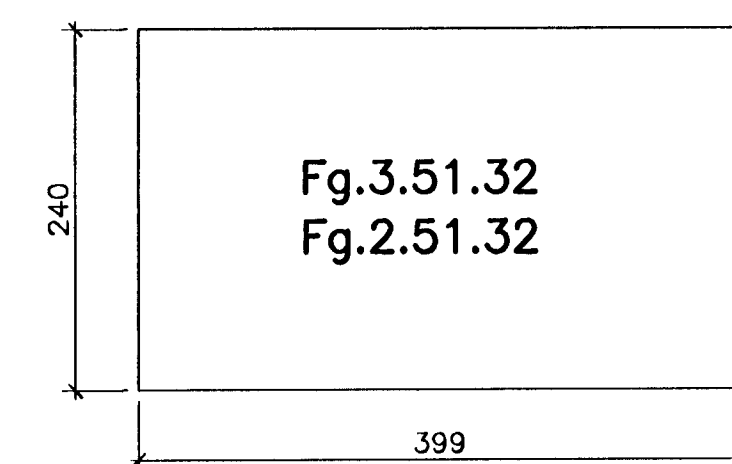
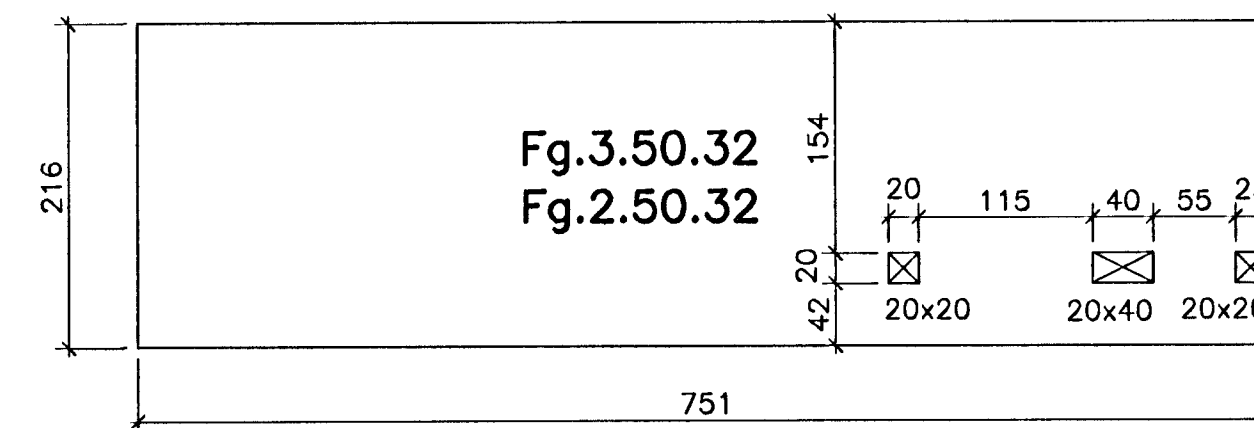
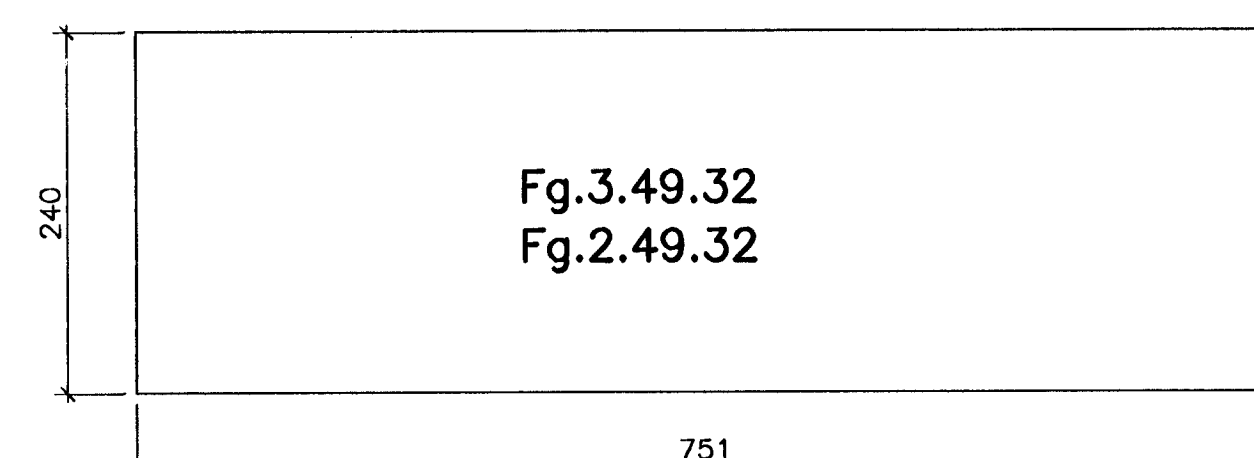
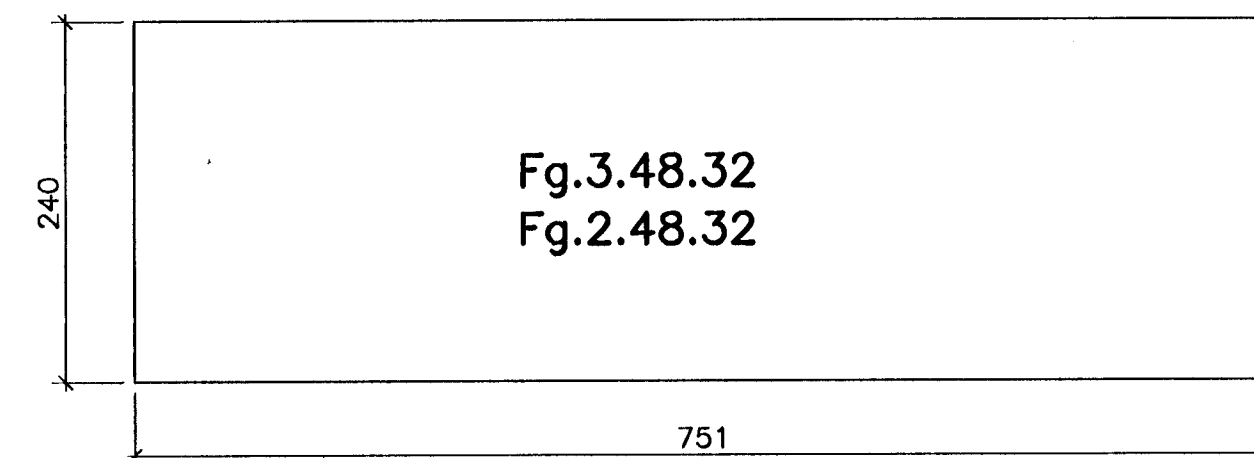
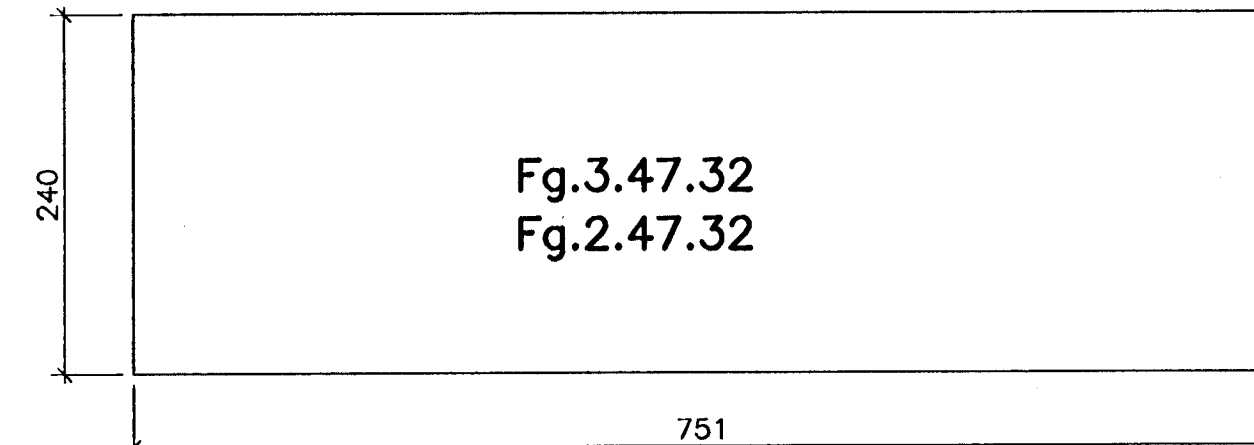
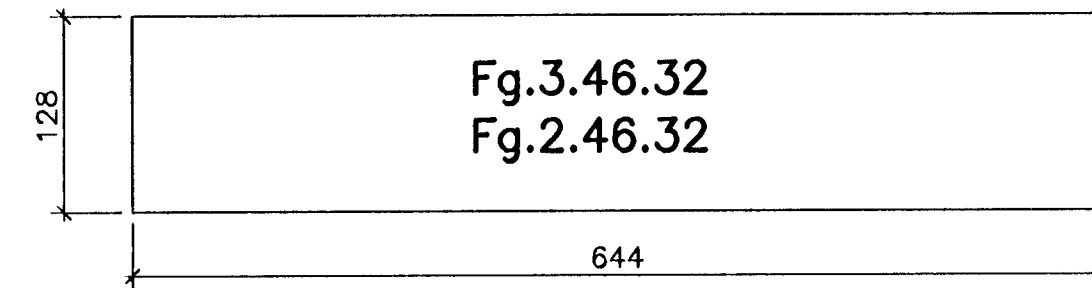
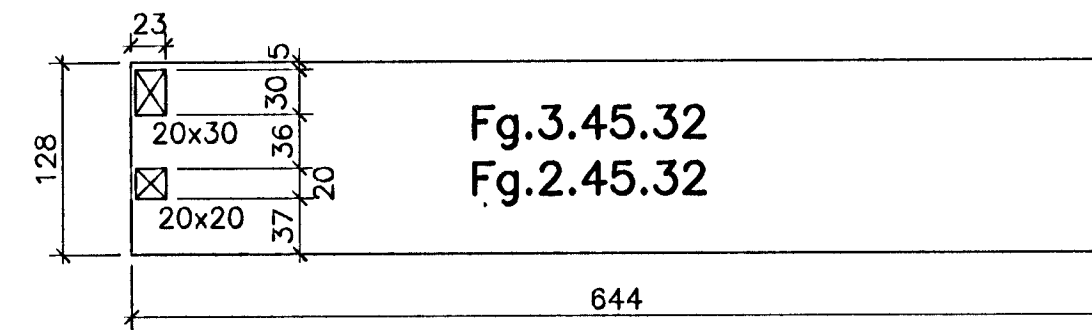
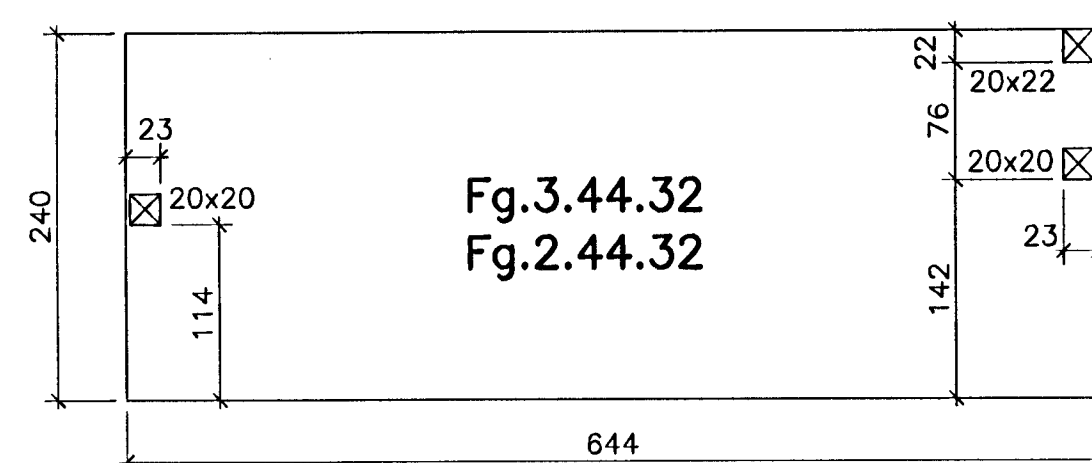
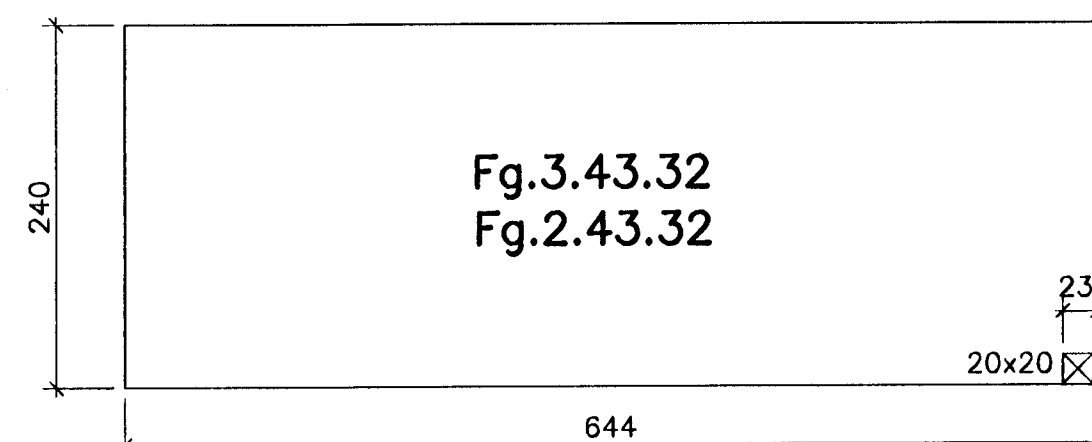
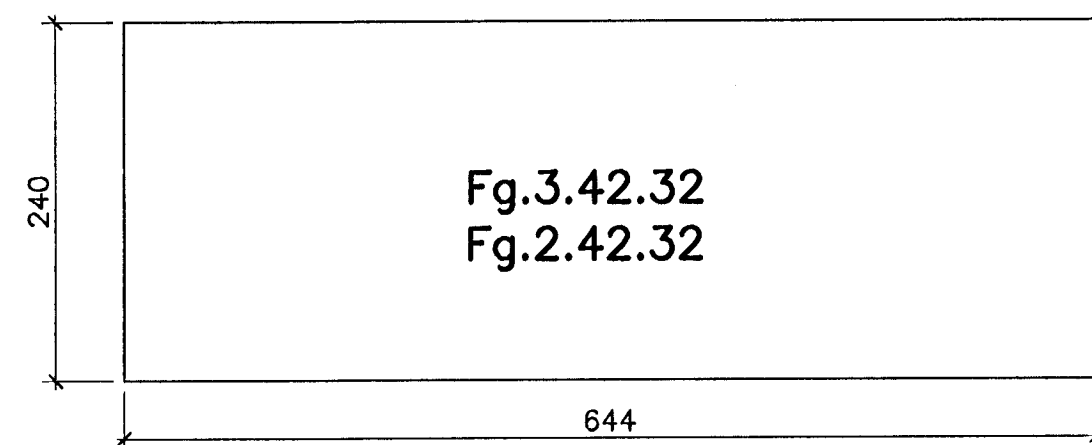
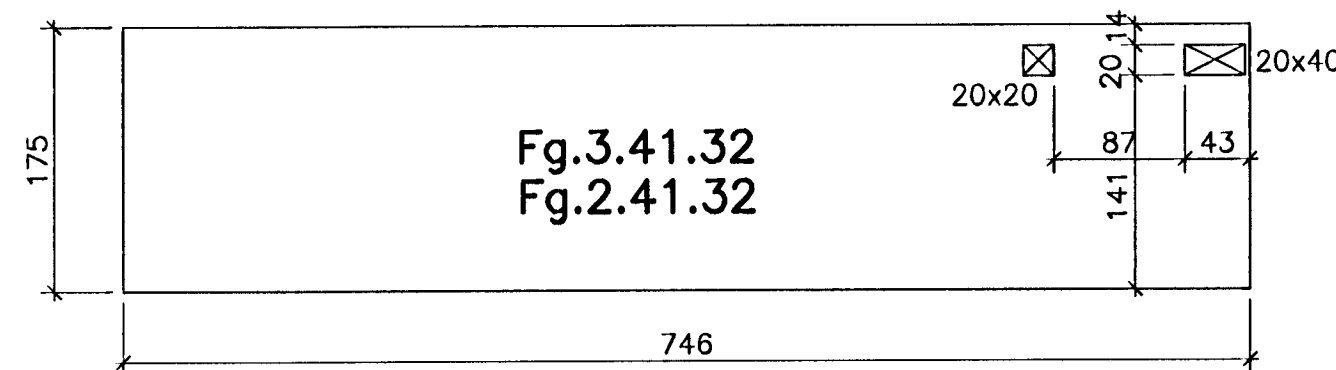
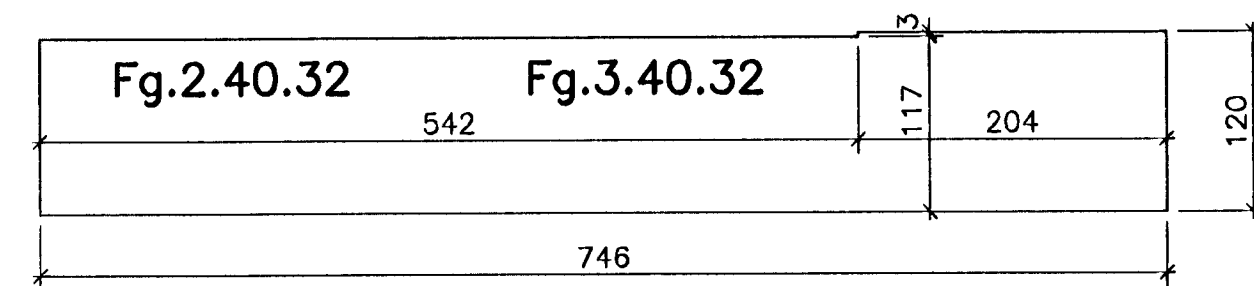
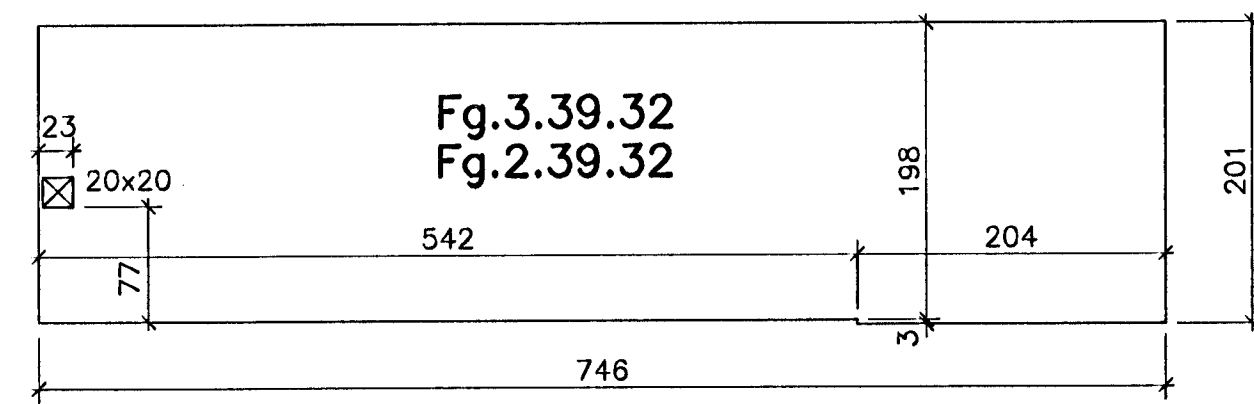
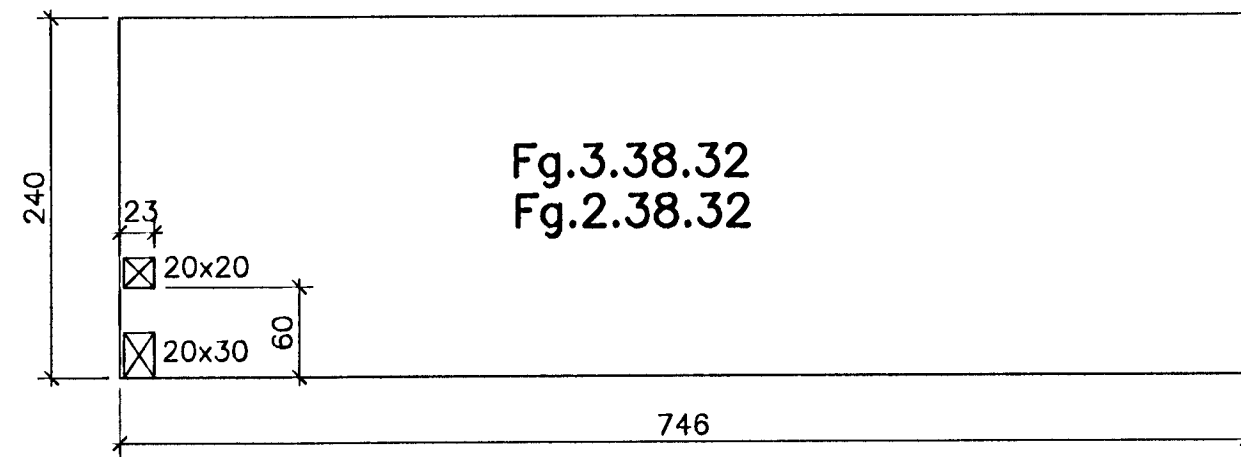
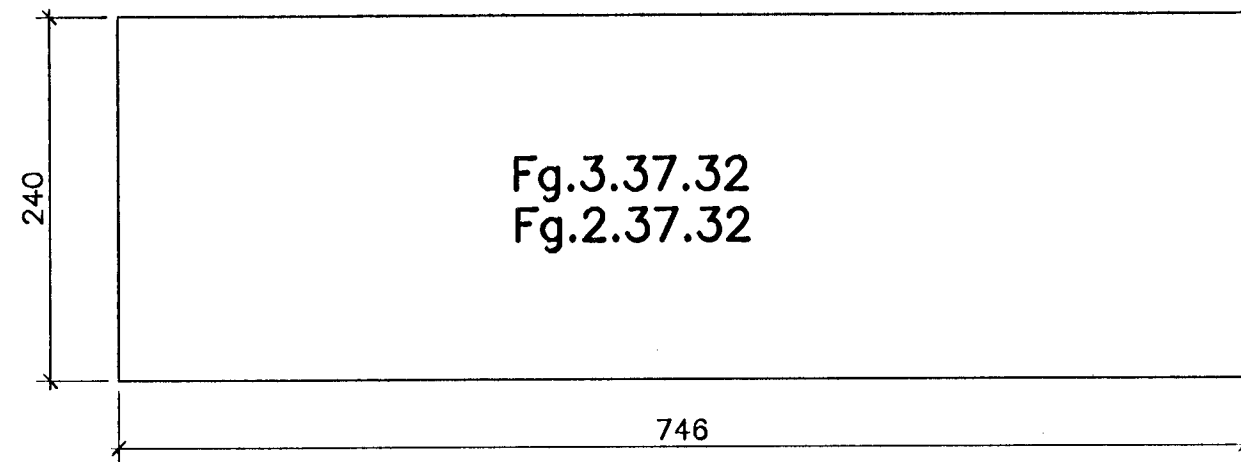

## SKÝRINGAR:

Allar loftaplötur eru forsteyptar og forspennar 8 cm þykkar filegranplötur. Tengistigar (filegran-trager) eru 14 cm háir með 90 cm bili. Forspennukaplar eru spennir í 1050 MPa og eru með 30 cm millibili.

## Kennisnið í filegranplötur 1:20

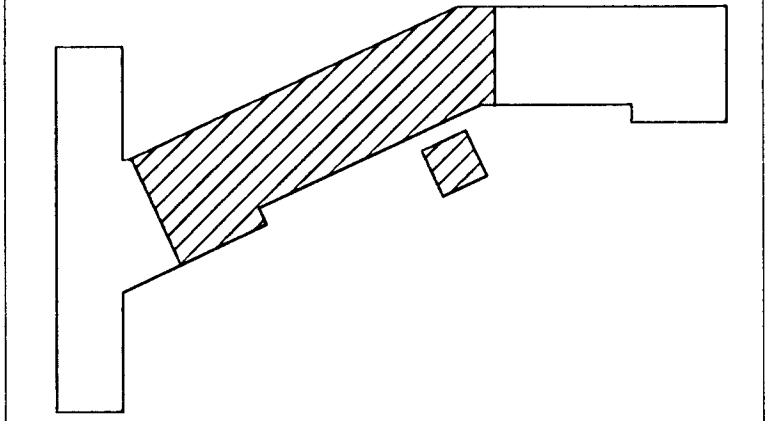
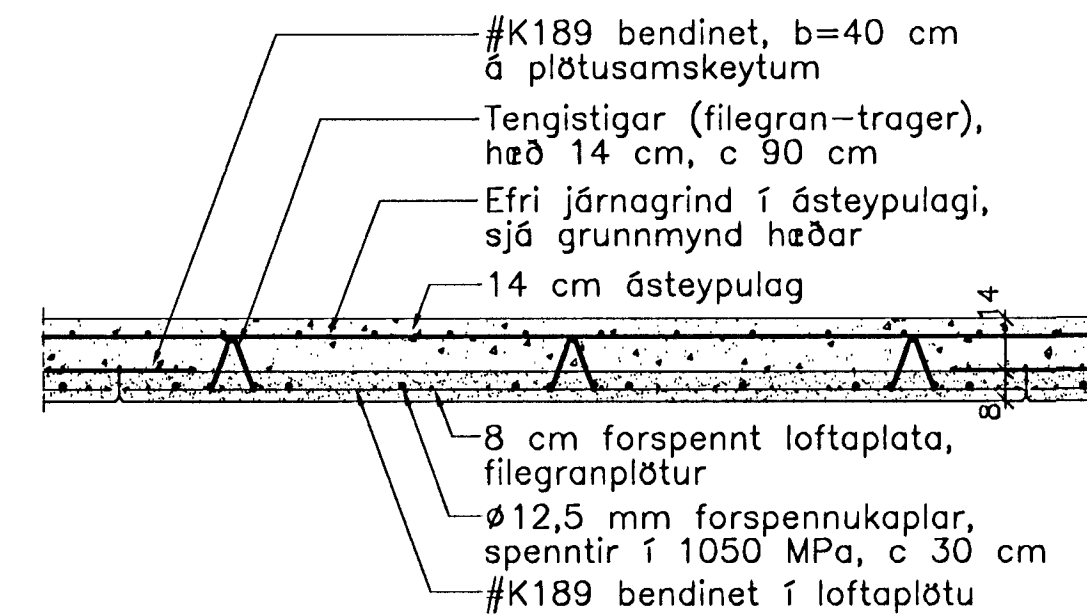

Breytingar:

*Vífill Oddsson*  
1012-3629  
Samþykkt þann 07 MARS 2005

**TEIKNISTOFAN ÖDINSTORGI**  
Byggingafræðingur í Hafnarfirði  
Eh. Sigurbjartur Halldórsson

Verkefni: Lækjargata 32 Hafnarfirði  
Heiti: Járnbent steypa: Forsteyptar loftaplötur yfir 2. og 3. hæð  
Hönnun: Vífill Oddsson verkfræðingur

VÍFILL ODDSSON VERKFRÆÐINGUR  
kt. 101237-3629 FVFI - FRV  
ÓDINSGÖTU 7 REYKJAVÍK SÍMI: 510-2200  
FAX: 510-2201

M. 1:50 og 1:20  
R. V.O./K.S.G.  
T. K.S.G.  
Dags. des. 2004 Nr. 970-1-53