

Samþykkt á fundi bygginga-
nefndar þ. 25/6 1989
BYGGINGAFULLTRÚINN
Í HAFNARFIRÐI

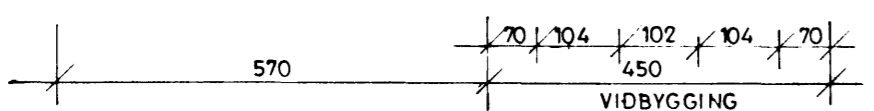

GRUNNMYND AÐALHÆÐAR 1:100

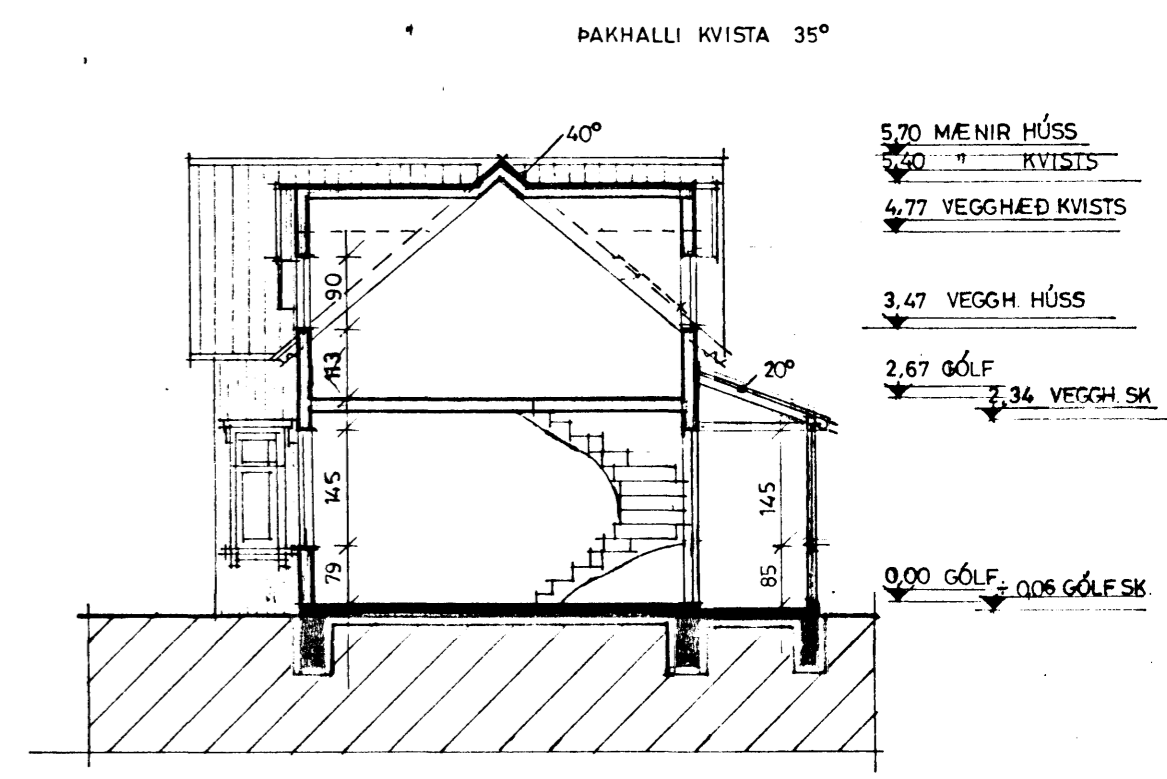
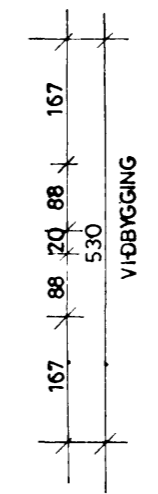
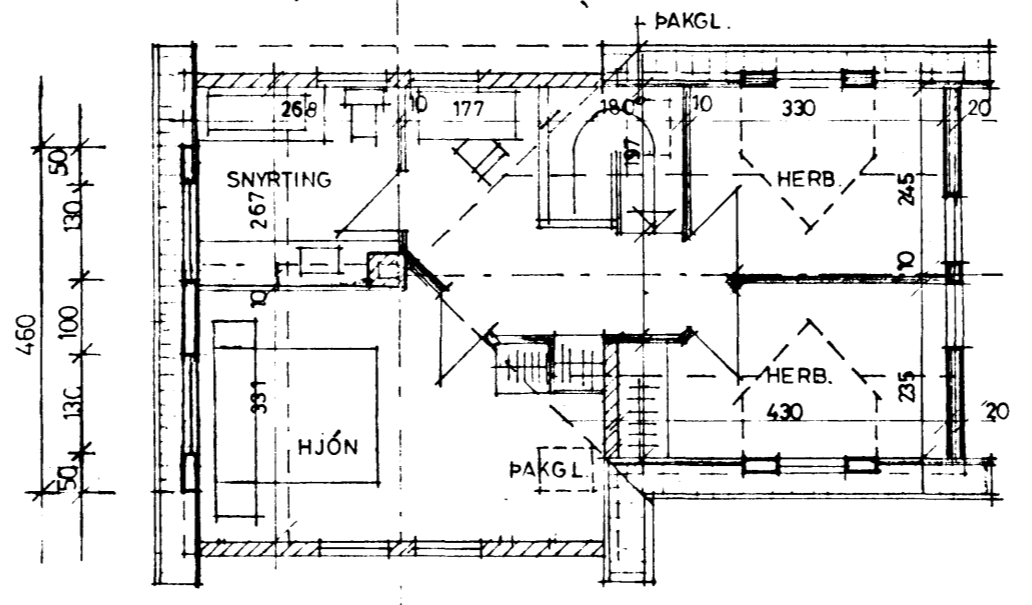
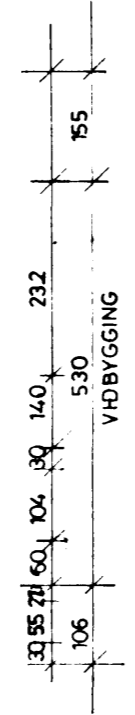
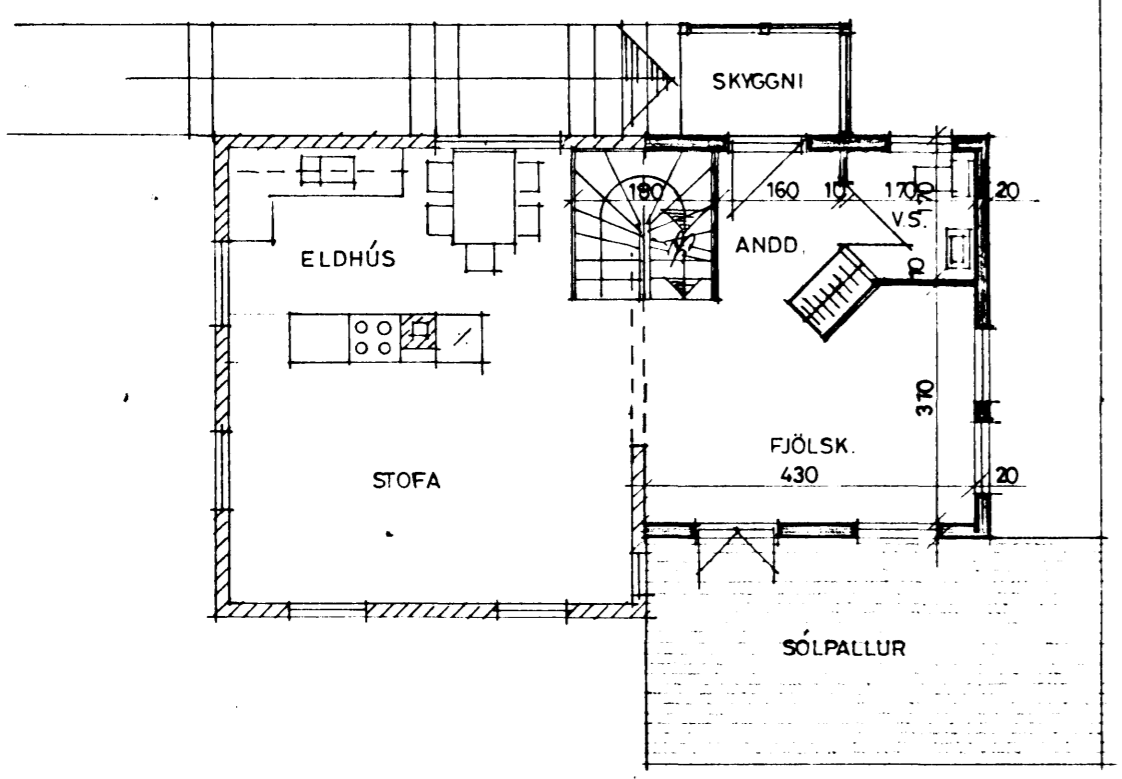
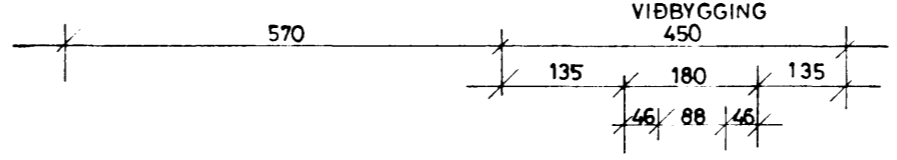
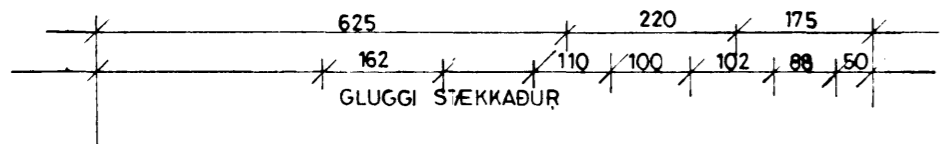
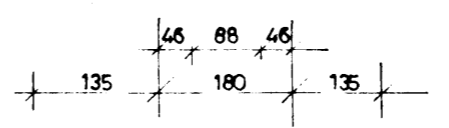

GRUNNMYND RISHÆÐAR 1:100

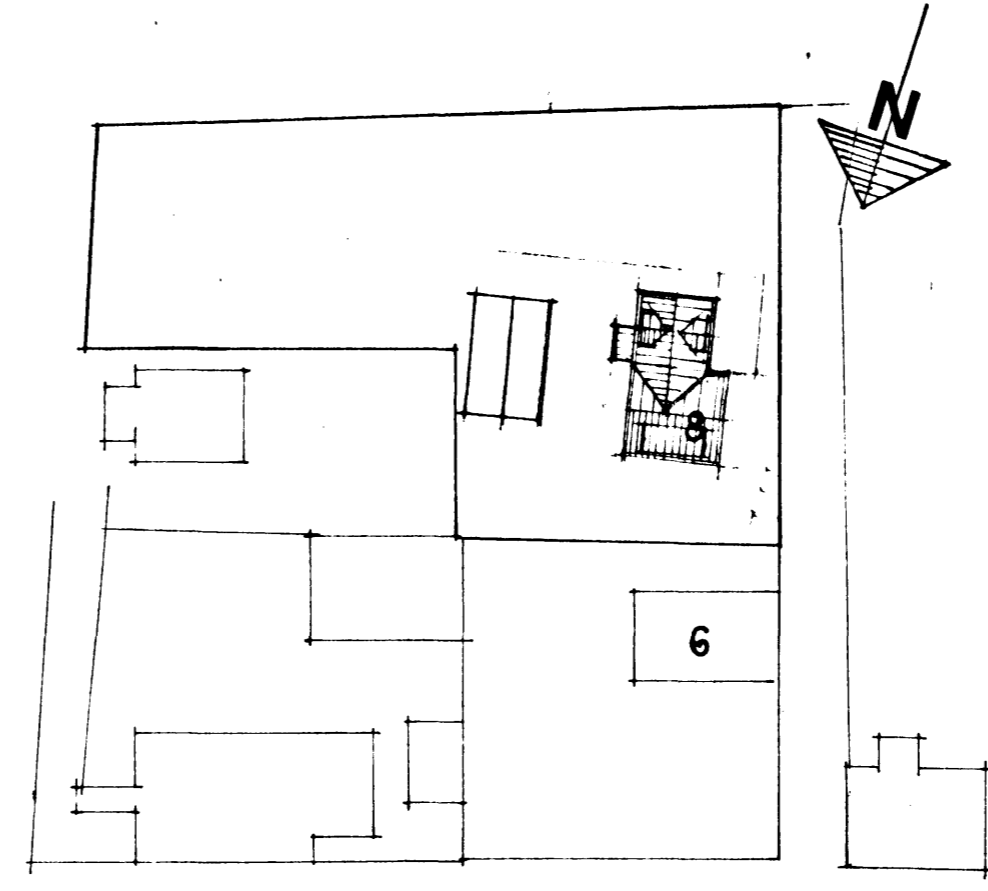
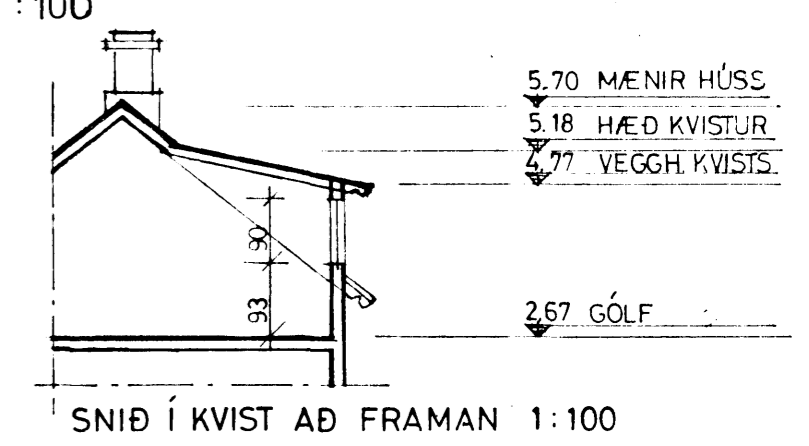

LÆKJARGATA

AFSTÖÐUMYND 1:500

STÆKKUN: BRÚTTÓ		
ADALHÆÐ	23,8 m ²	63,6 m ³
RISHÆÐ	23,8 "	46,4 "
ALLS:	47,6 m ²	110,0 m ³
<hr/>		
HÚSIÐ ALLS EFTIR STÆKKUN	156 m ² br.	348 m ³ br.

ÖLL MÁL STAÐFESTIST MEÐ MÆLINGU Á STAÐNUM.

BREYTT Í JÚNÍ 1989

TEIKNISTOFAN SUÐURGÖTU 14 220 HAFNARFJÖRÐUR
PÁLL V. BJARNASON ARKITEKT FAI SÍMI 54355

51.02

LÆKJARGATA 8 HAFNARFIRÐI VIÐBYGGING
GRUNNMYNDIR, SNID, AFSTÖÐUMYND

Páll V. Bjarnason

DAGS	JÚNÍ 1987
KVARDI	1:100 - 1:500
HANNAD	P.V.B.
TEIKNAD	A.E.
YFIRE.	P.V.B.