

Þessi skilríki er fundi by. 19.12.84
 BYGGINGARLÖG
 I HANANUM
S. Jónsson

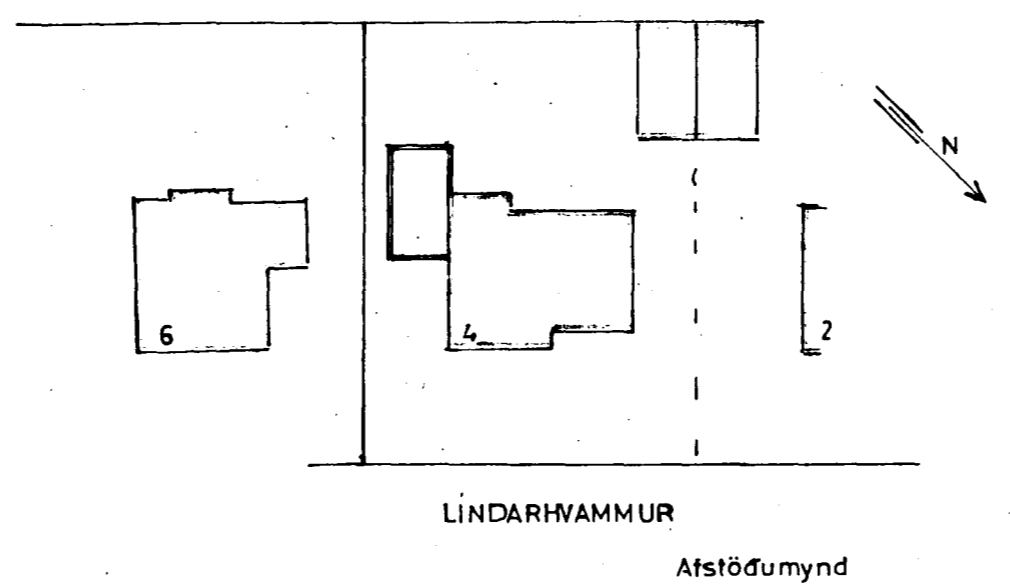
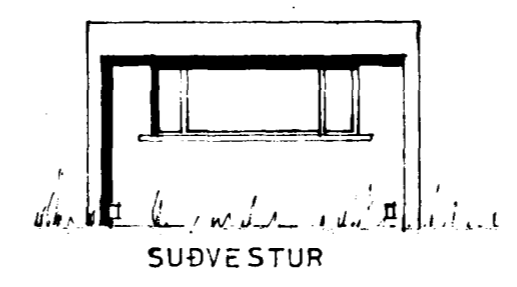
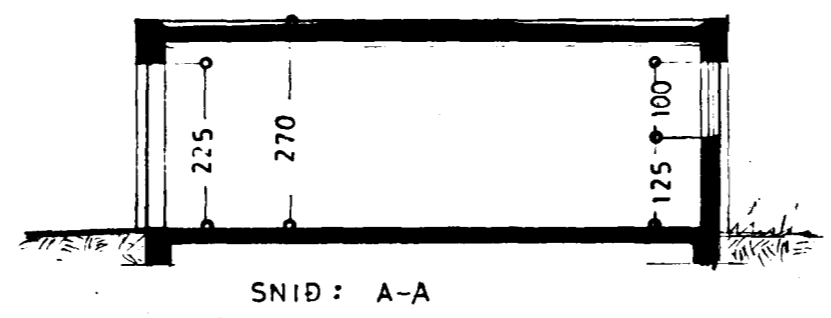
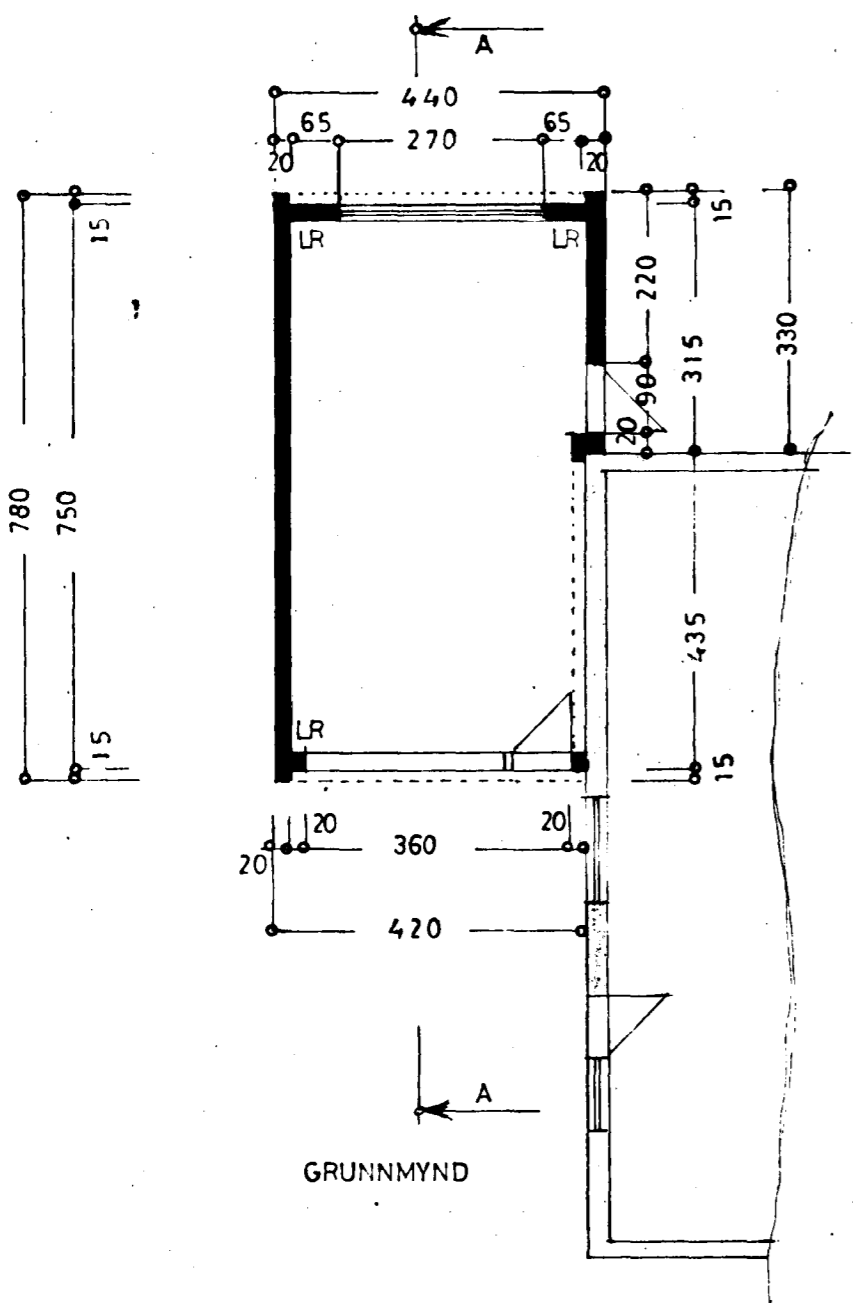
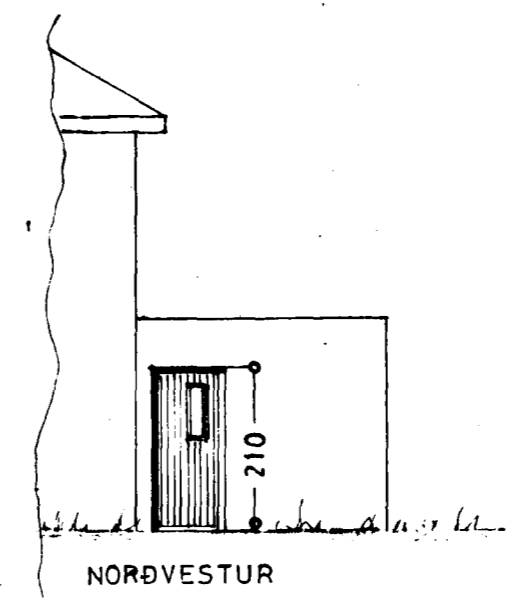
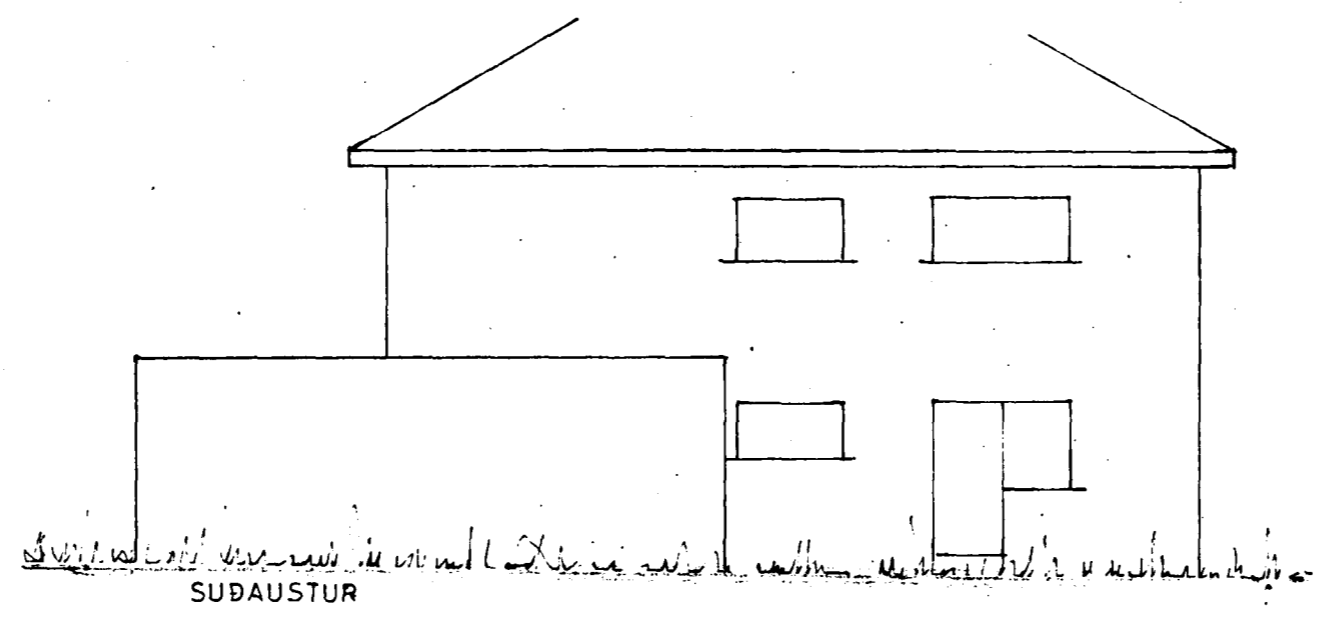
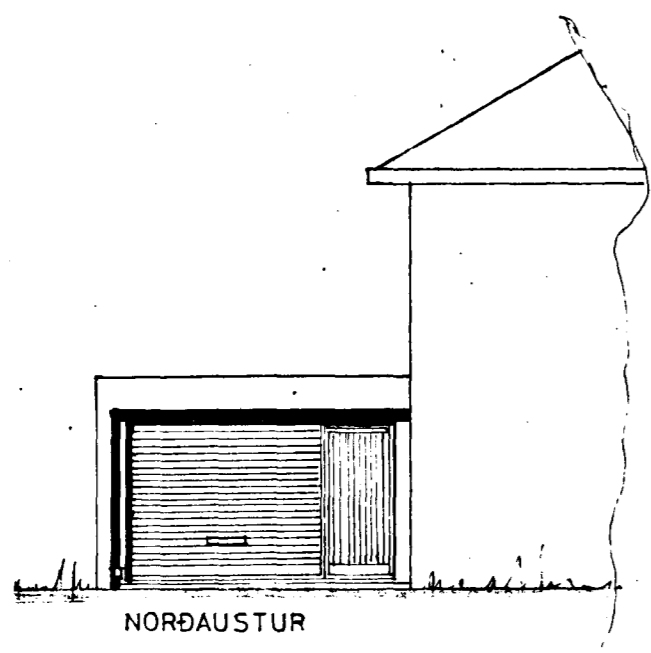

5640-0040-03

STÆRD BÍLG. $32,1\text{ m}^2, 86\text{ m}^3$

LINDARHVAMMUR NR 4

BÍLGEYMSLA

ÚTLIT }
 GRUNNMYND } 1:100
 SNID }
 AFSTÖÐUMYND 1:500

Jónsson 2. okt. 1984
S. Jónsson