







SKÝRINGAR:

-  Steyptur útveggur, einangraður með t.d. 85 mm polystyren einangrun og hefðbundinni múrhúðun.
-  Steyptur innveggur
-  A-EI-60 veggur, t.d. 100 mm múrhúðaður vikursteinn, eða 2x2x13 mm gifs á 95 mm blikkstoðir/100 mm einangrun.
-  Hefðbundinn innveggur t.d. 70 mm grind c/c 600 mm, klædd 2x13 mm gifsi eða 1x16 mm spónaplötum/einangrun.
-  Léttur veggur sem verður fyrir vatnsáraun. Klæddur rákavörðu gifsi.

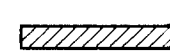

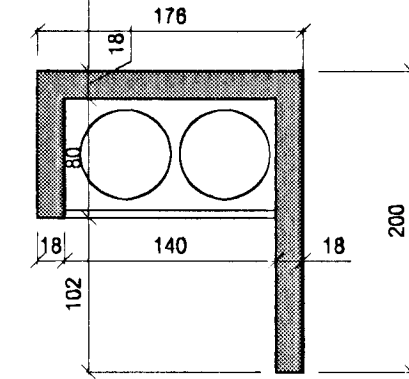
VEKTOR
- hönnun og ráðgjöf -
Nybýlavegi 6, 200 Kópavogur.

Ríkharður Oddsson
byggingafræðingur
N. 270281-5159
sími: 554-6650 fax: 554-6688.

Teikn. nr. Tilvísun á teikningu
Samþykkt 

Br. Dags.

LÓUÁS 3, HAFNARFIRÐI
GRUNNMYND

Hannað RO Teiknað SM
Dagsetning 02.04.'01 Verk nr. A-01-03-06 Mælikvæði 1:50 Teikn. nr. S-01

Samþykkt þann
06 APR. 2001
Byggingafrúnni í Hafnarfirði
Eh. Sigurbjartur Halldórsson