

2/12 '98
Óskad eftir fulltöku
[Signature]

EYRARTRÖÐ.

BLAÐ. I

HVALEYRARBRAUT.

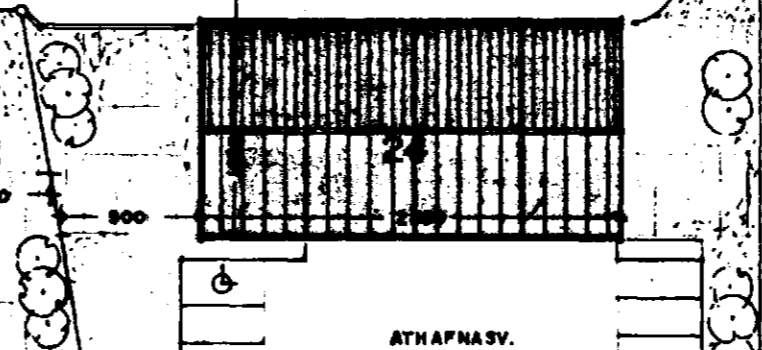
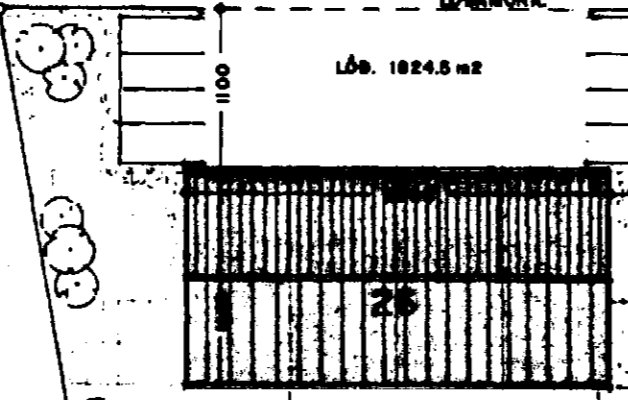
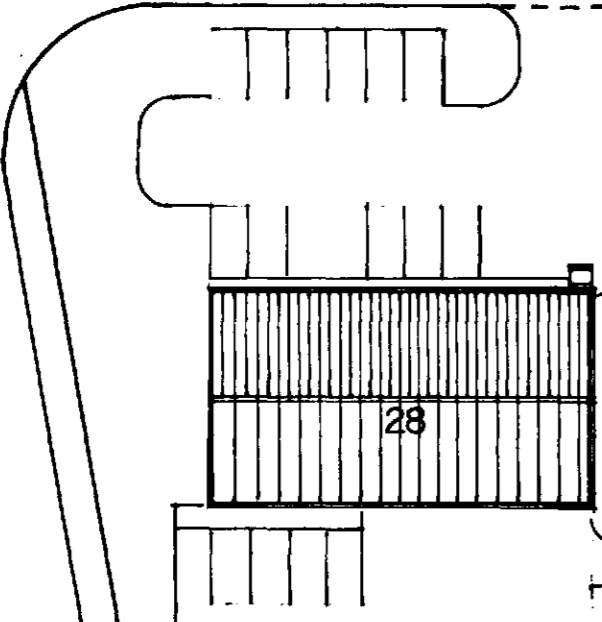
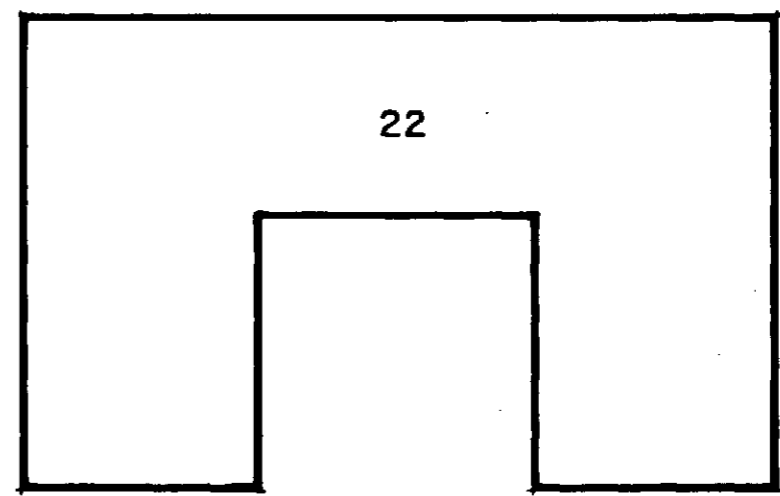
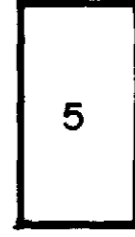
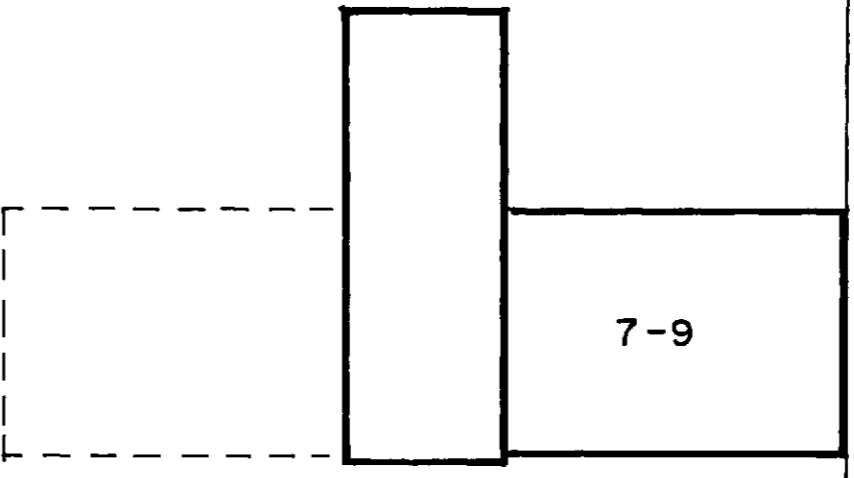
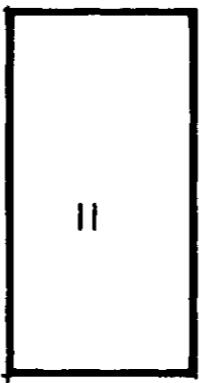
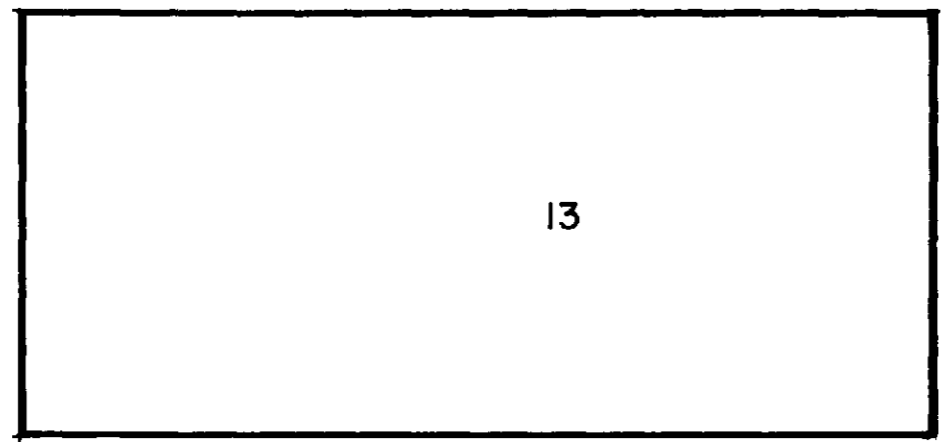

LÓÐ. 1824.5 m²

LÓÐ. 2178.2 m²

NÝTINGATALA LÓÐAR NR. 24 - 0.36
NR. 26 - 0.43

MELABRAUT.

GANGSTÍÐUR.

AFSTÖÐUMYND. 1:500

MELABRAUT 24-26 HAFNARFIRÐI. AFSTÖÐUMYND.

VERK. NR. 199 DAGS. 17-11-1998 MÁL. 1:500
TEIKN. NR. 01 BREYTT.

JON GUÐMUNDSSON ARKITEKT *Jon Guðmundsson* ST. SIÖBBI 3208
VINNUSTOFA: SKÚLAGÖTU 63 REYKJAVÍK. SÍMI. 552-5055