

EYRARTRÖÐ.

BLAÐ. I

HVALEYRARBRAUT.

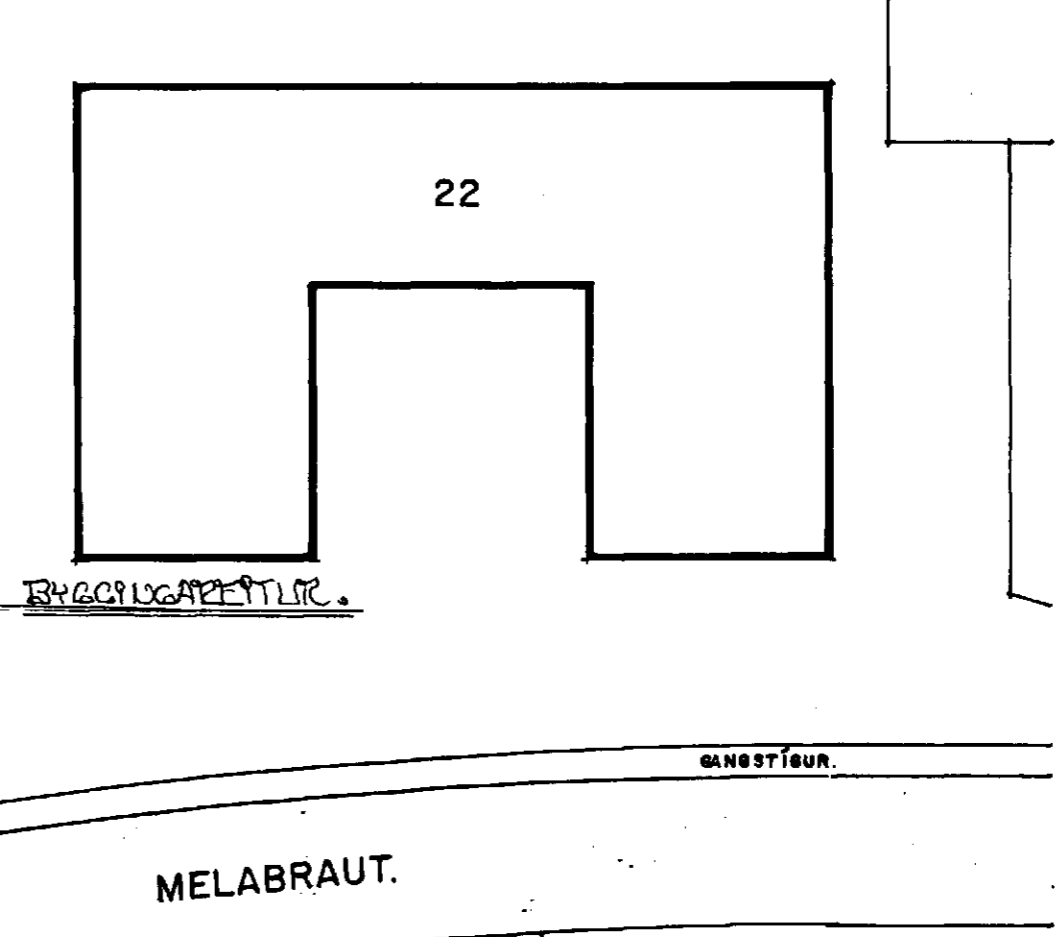
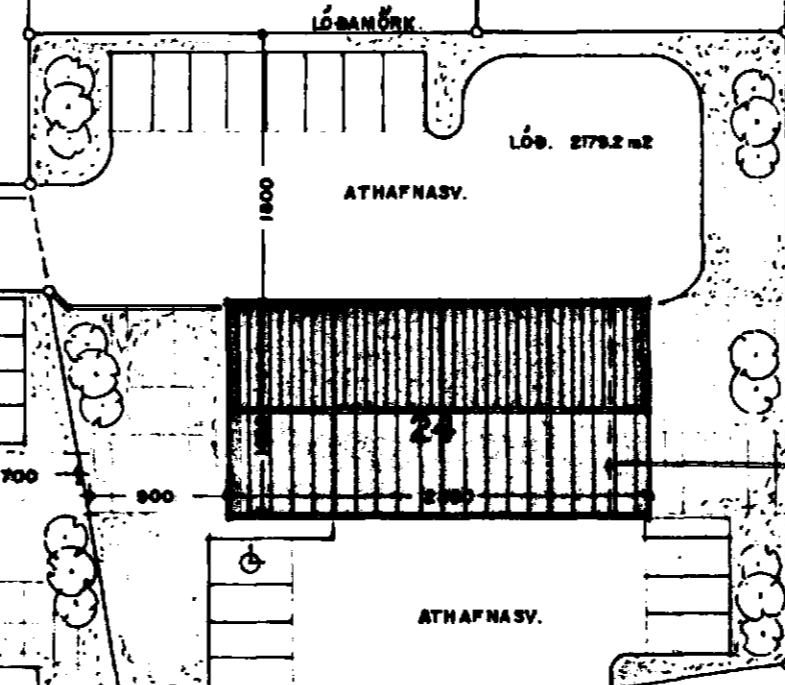
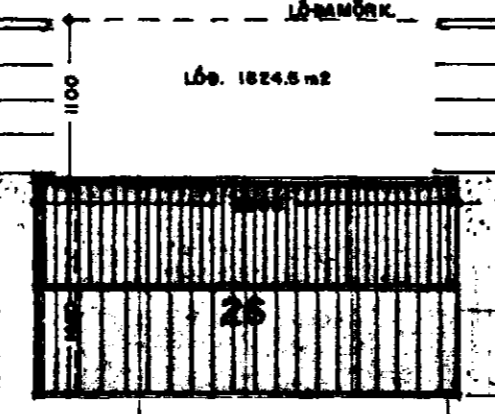
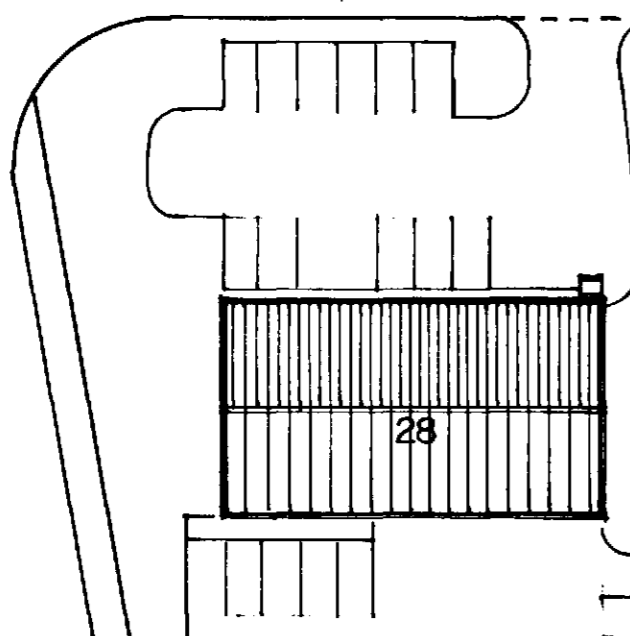
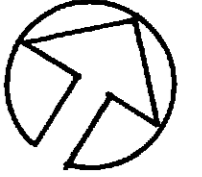
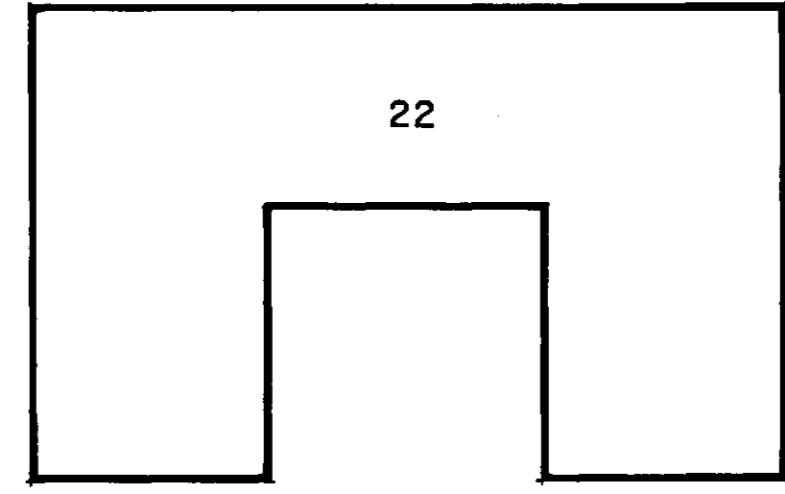
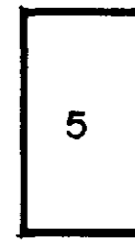
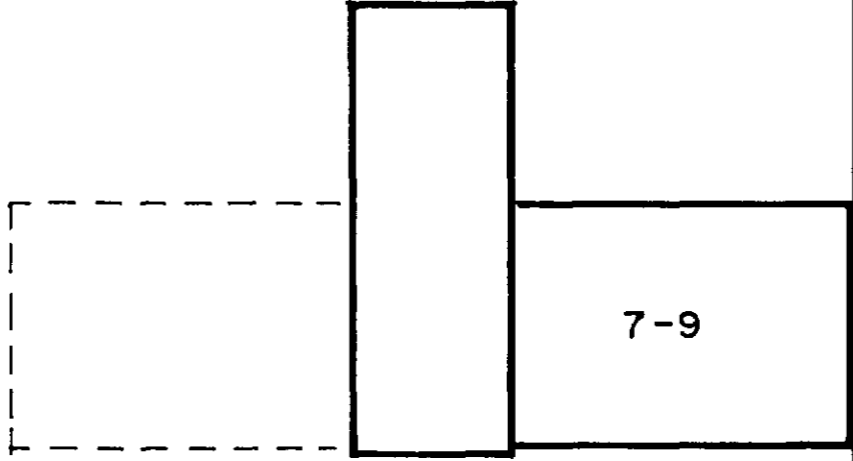
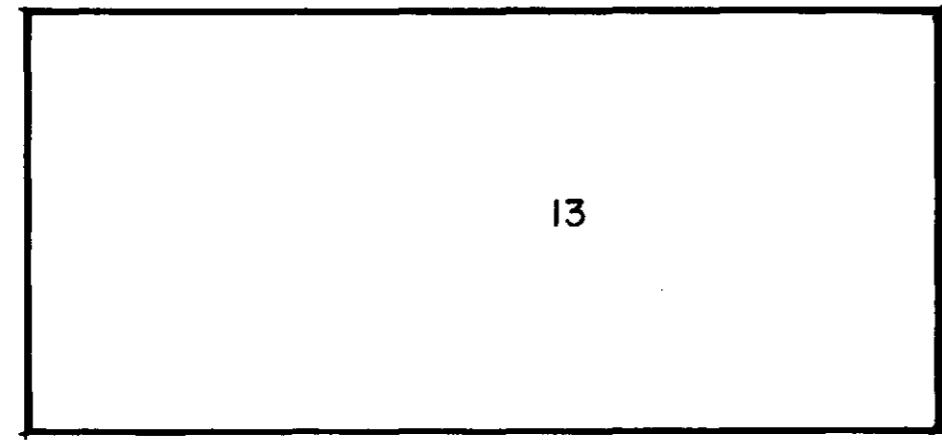

LÓÐ. 1824.8 m<sup>2</sup>

LÓÐ. 2792 m<sup>2</sup>

NÝTINGATALA LÓÐAR NR. 24 - 0.36  
NR. 26 - 0.43

AFSTÖÐUMYND. 1:500

MELABRAUT 24 - 26 HAFNARFIRÐI. AFSTÖÐUMYND.

VERK. NR. 199      DAGS. 17-11-1998 MÁL. 1:500  
TEIKN. NR. 01      BREYTT.

JÓN GUÐMUNDSSON ARKITEKT *Jón Guðmundsson* KT. 310881 3209  
VINNUSTOFA.: SKÚLAGÖTU 63 REYKJAVÍK. Sími. 552-5055