

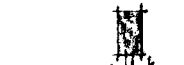



TENGINYIÐ OFNAKERFIS MK ~ 1:50.

MERKINGAR.

-  MERKIR MÆLIR (HITAVEITA.)
-  MÓTORLOKI
-  MISMUNARPRÝSTINGSSJAFNARI
-  RENNILOKI
-  HEMILL
-  EINHSTREYMILOKI
-  SÍA
-  ÖRYGGISLOKI
-  DEILA 12 L/MÍN MÓTI 1500 MM K.
-  HITA OG PRÝSTINGSMÆLIR.
-  BLÖNDUNARVENTILL.
-  TEMING ϕ 15.

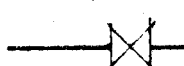
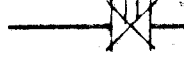
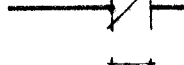
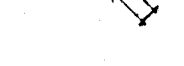
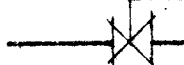

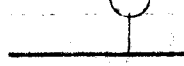
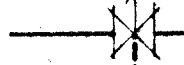
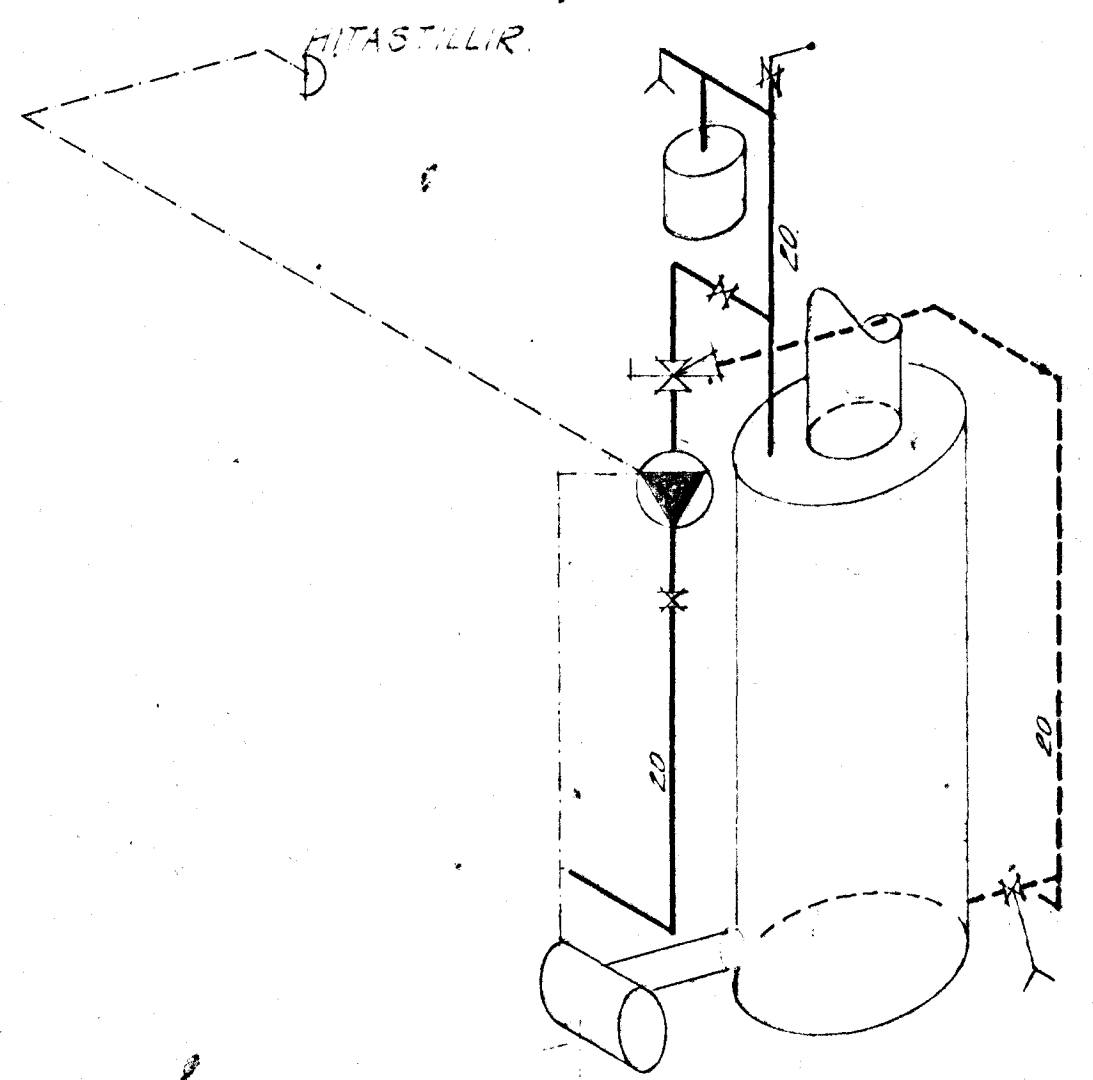
TENGING VIÐ KETIL

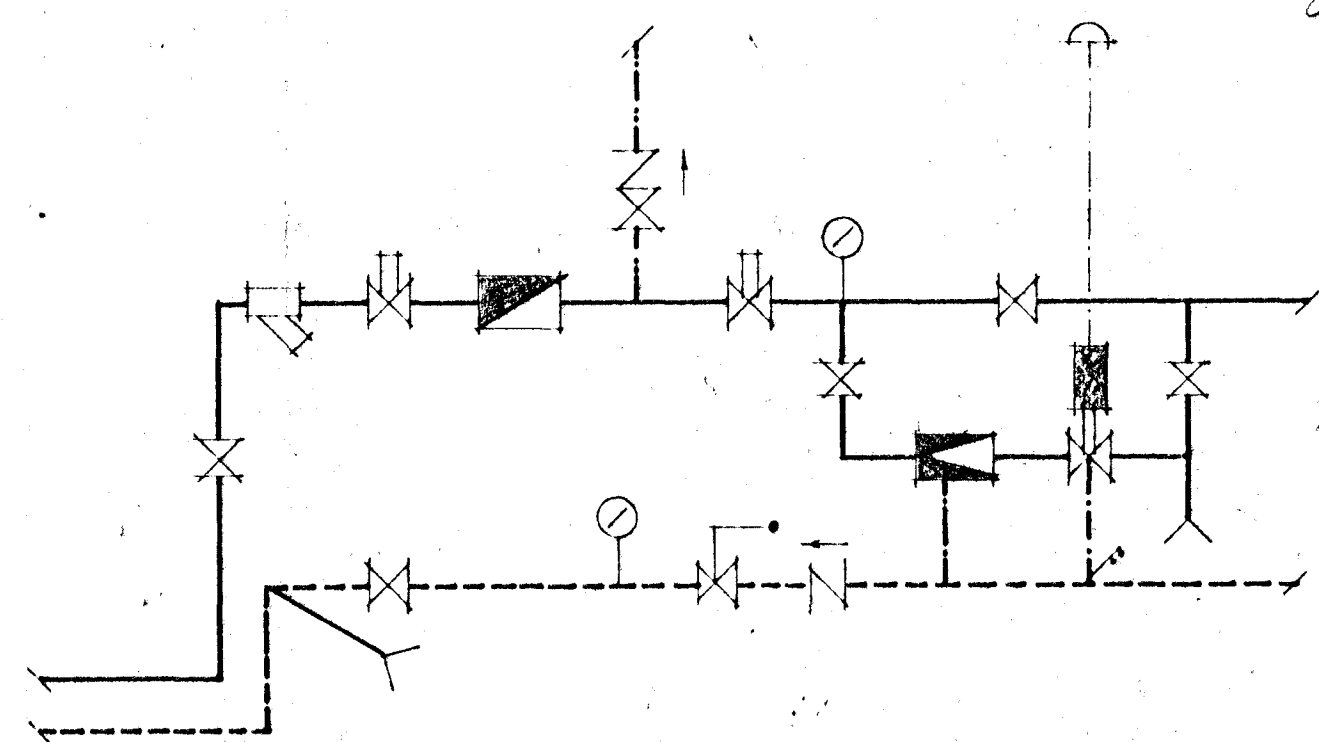

TENGING VIÐ HITAVEITU (TVÓFALT KERFI).

KETILL 3 M² MED INNBYGGÐUM NEYZZLUVATNSSPÍRAL.
 BRENNARI 2,5 - 125 G. PRT.
 BENSLUKER LOKAÐ, TÖ TACD 35-5016
 Á ALLA OFNA KOMI THYSTILLILOKI OG LOFTTEMINGARSKR.
 ÖLL OFNTENGI SEU ϕ 10.

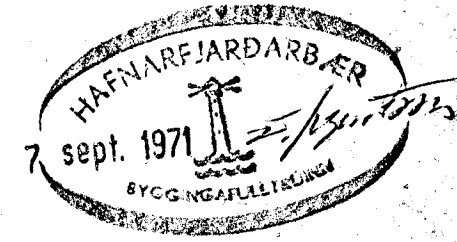

HÚSNÆÐISMÁLASTOFNUN RÍKISINS.	
HITALÖGN	SÉRTEKNING.
BLAÐ 2 AF 2.	VERK NR 1052
	MKV. 1:50, 1:20. JUNI 1968.
Sigrundur P. Kristjánsson	