

Bulgeymala
 Aðalsteinsfirnboqsonar
 Ólafur Stephansen
 Ölduslöt 22-20

Flatarmál 484 m²
 Rúmmál 143.75 m³
 Málkv. 1:100

Afstöðumynd 1:500

Ölduslöt

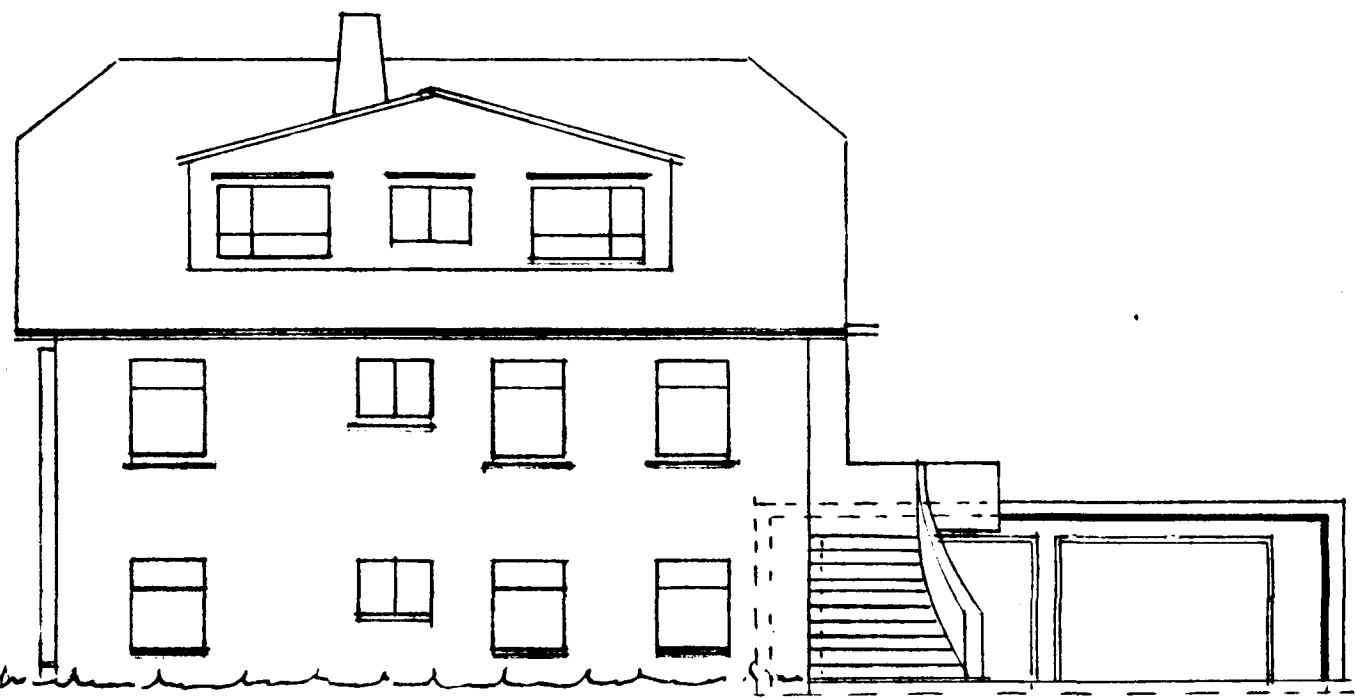
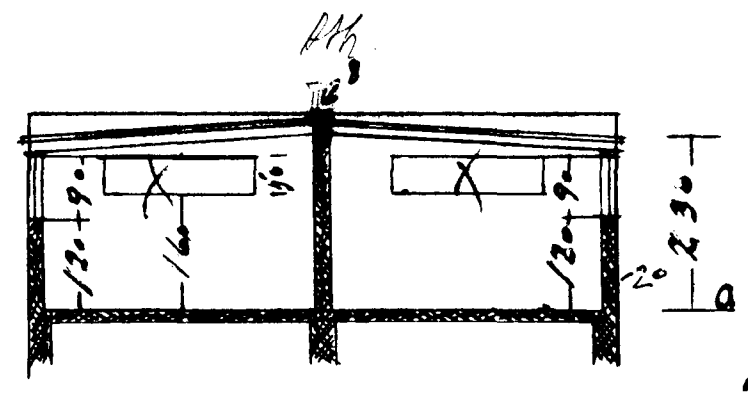
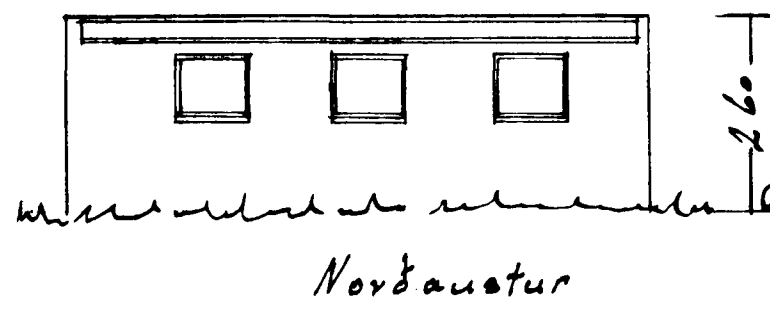
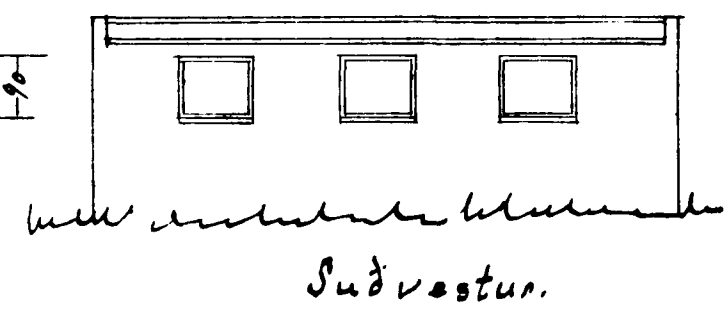
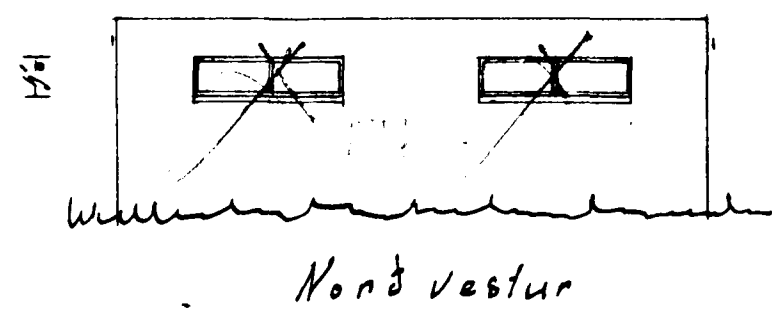
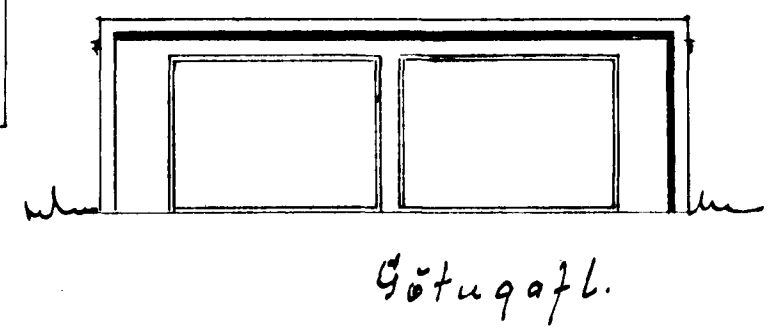
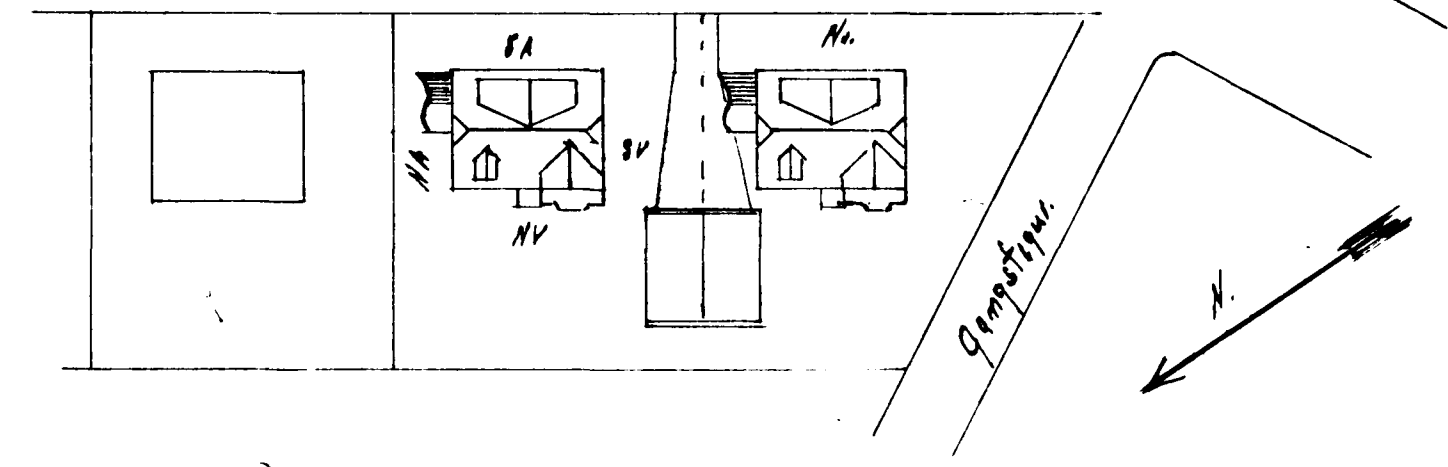

Samþykkt á fundi bygginga-
 nefndar þ. 10. 7. 1968

BYGGINGAFULLTRÚINN
 I HAFNARFIRÐI
 Sigurðsson

- Skilyrði.
- a) Samkomulag sé tekið lóðarhafa að liggjandi löðu nr. Hringbraut um fyrirkomulag og þrjúgang löðarmark.
 - b) Slúsa á norðvesturgöfl falli niður.
 - c) Eldvarnarsigur á milli geymslanna nái 15 cm upp yfir þakbrún.

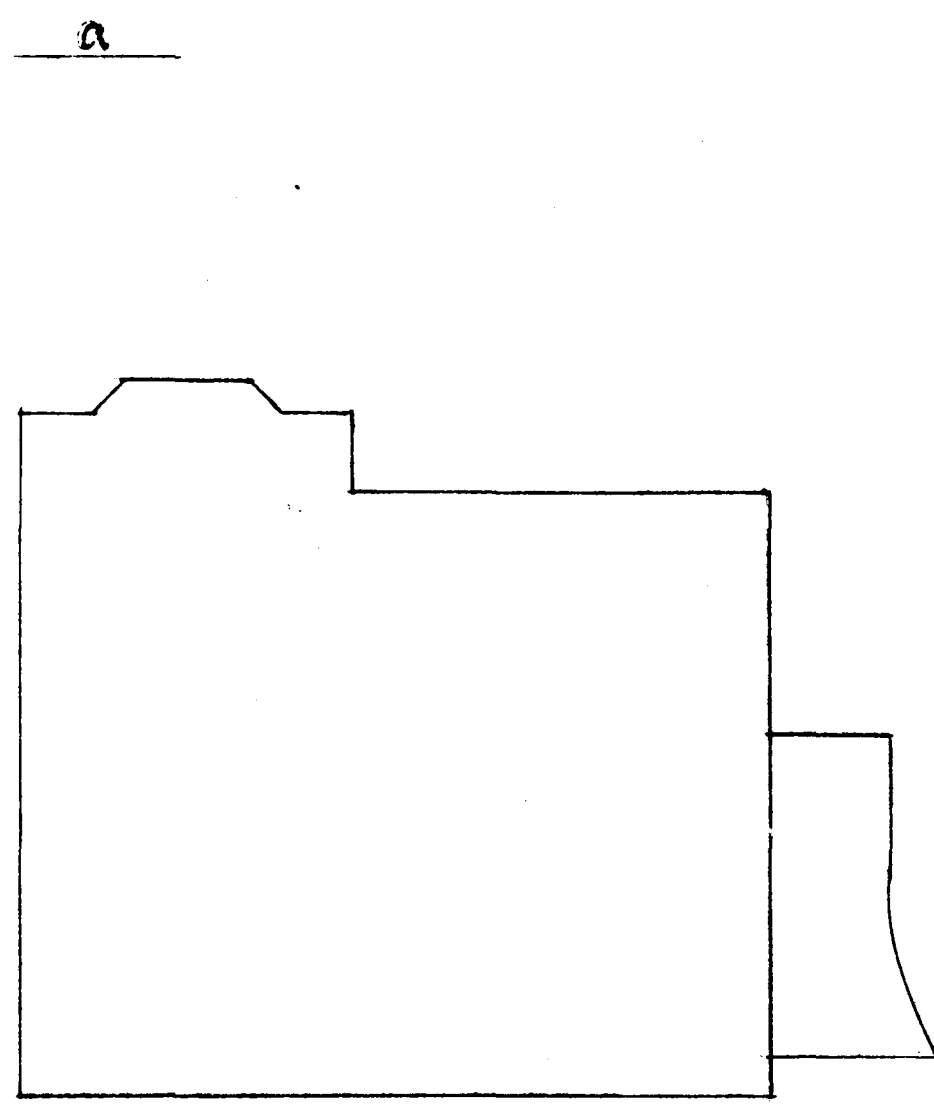
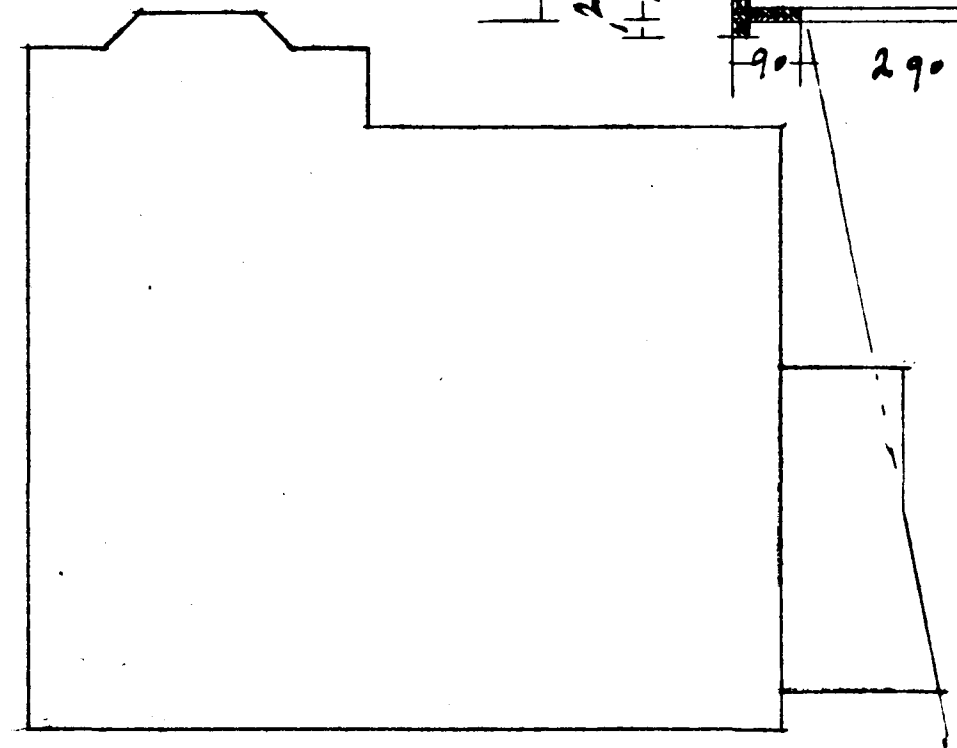
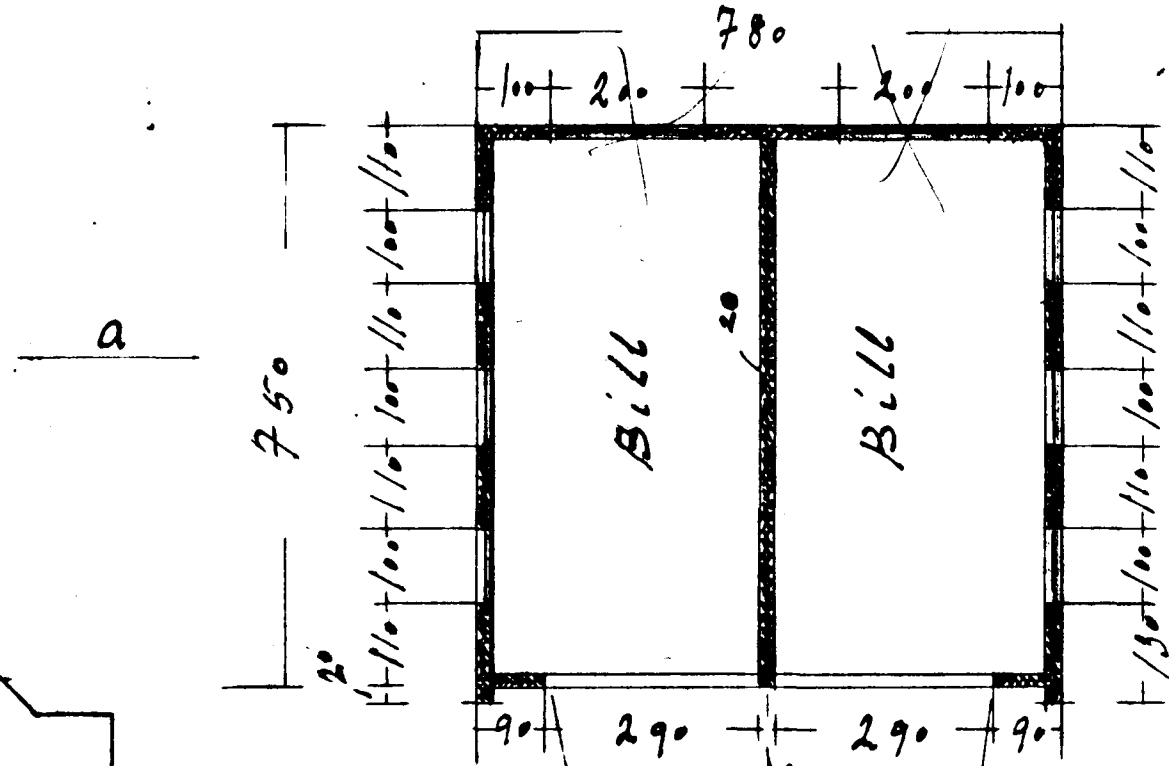

Hafnarfirði júní 1968
 Sigurður Guðmundsson