

UNDIRSTÖÐUR, GRUNNMYND. 1:50

Samþykkt bann  
02. mars 2022  
F.h. byggingarfulltrúans í Hafnarfirði  
Hjálmar A. Jónsson  
1-1A3

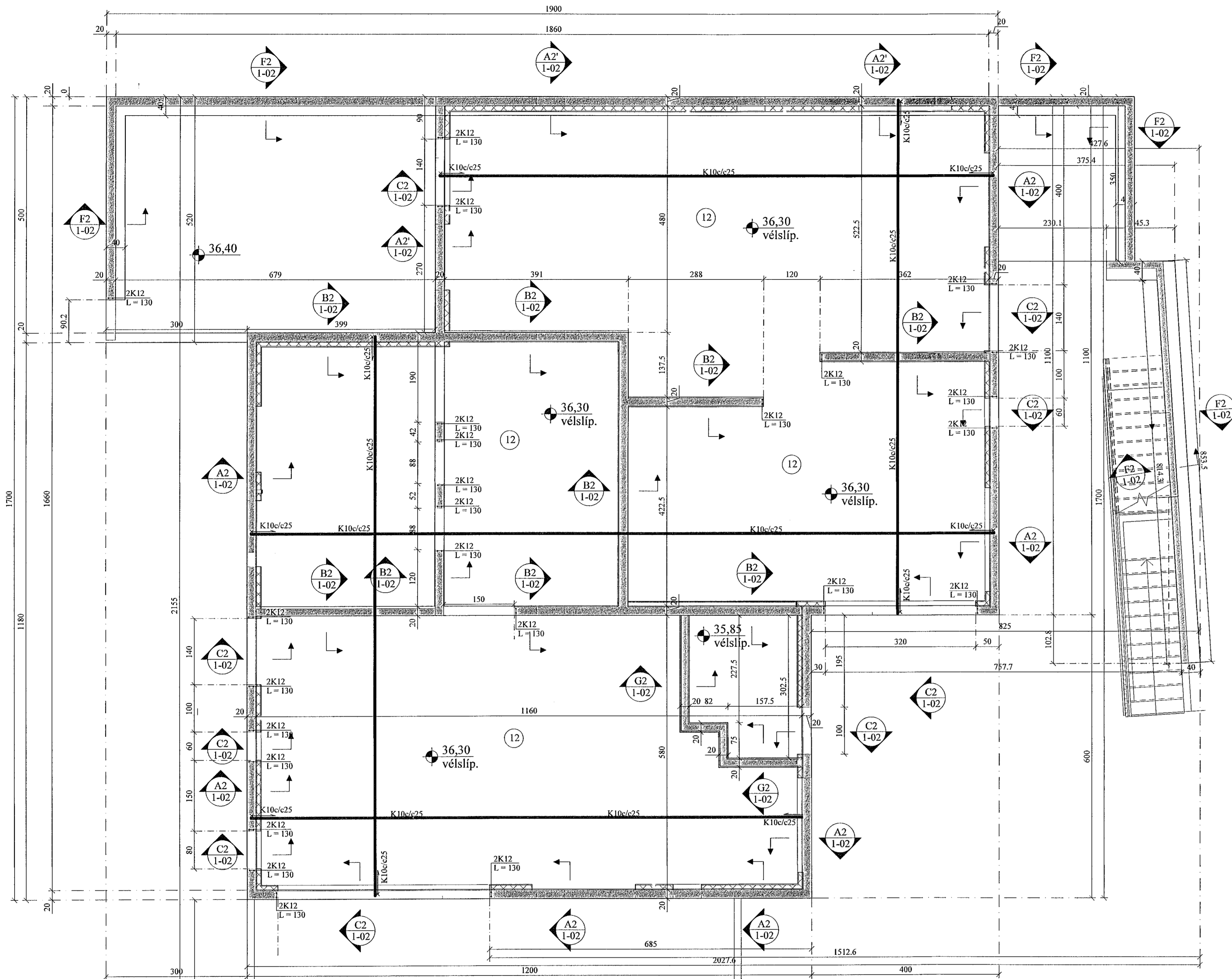

G2 SNIÐ. 1:20

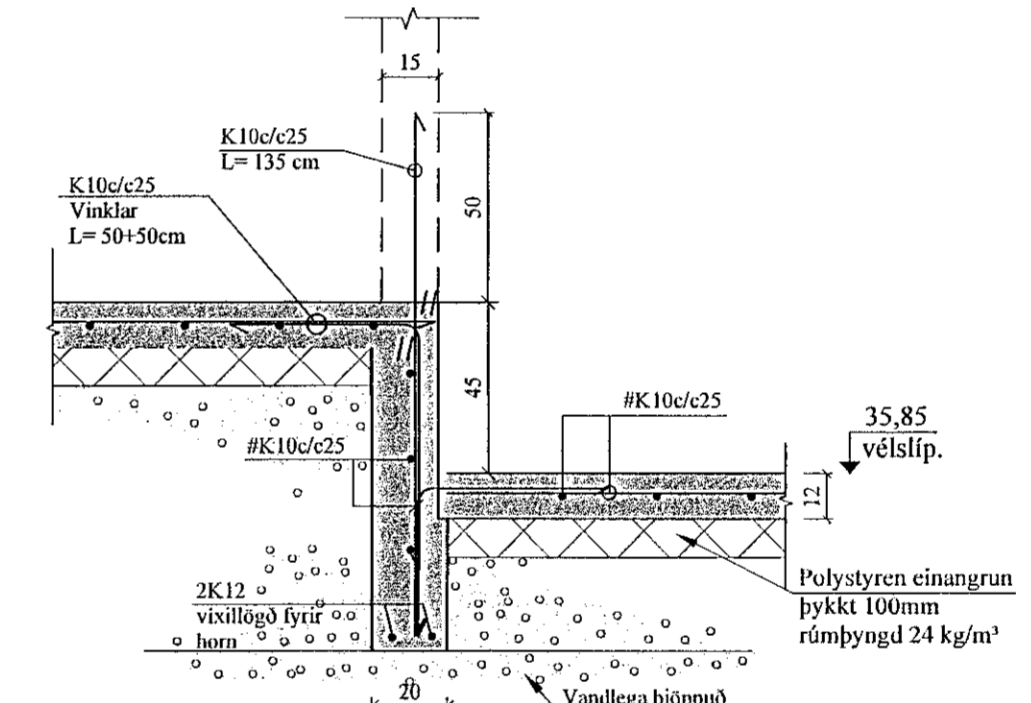

GÖT Í UNDIRSTÖÐUR:

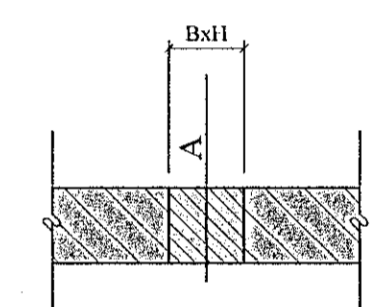

A = KÓTT Á NEDRI BRÚN GATS  
B = BREIDD GATS  
H = HÆÐ GATS

JÓN KRISTJÁNSSON BYGGINGARVERKFRÆÐINGUR  
KT: 210754-4829

BREYTINGAR

F2 SNIÐ. 1:20

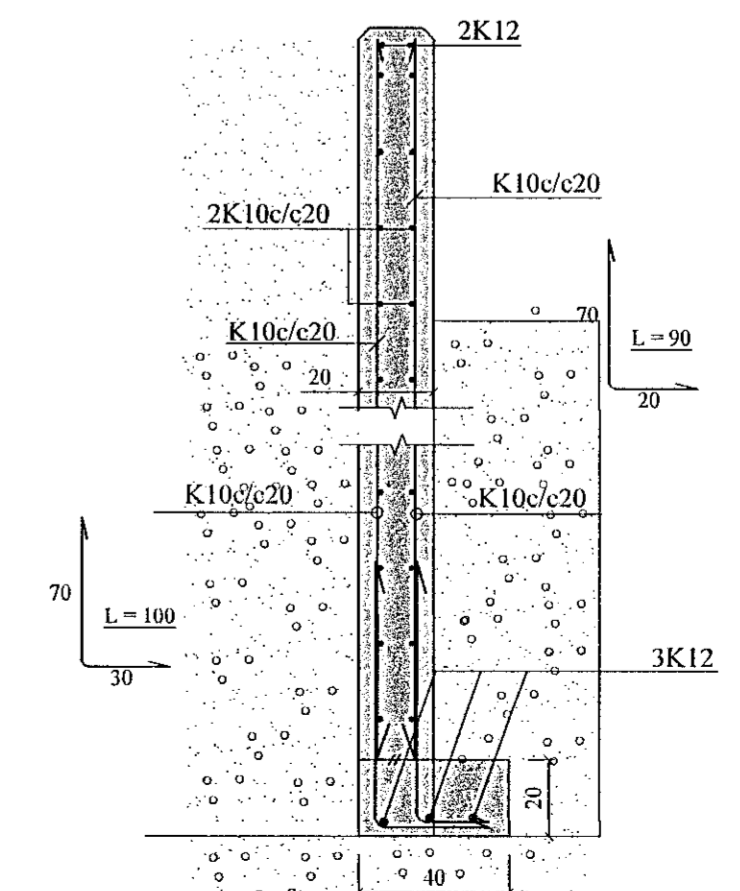

A2 SNIÐ. 1:20

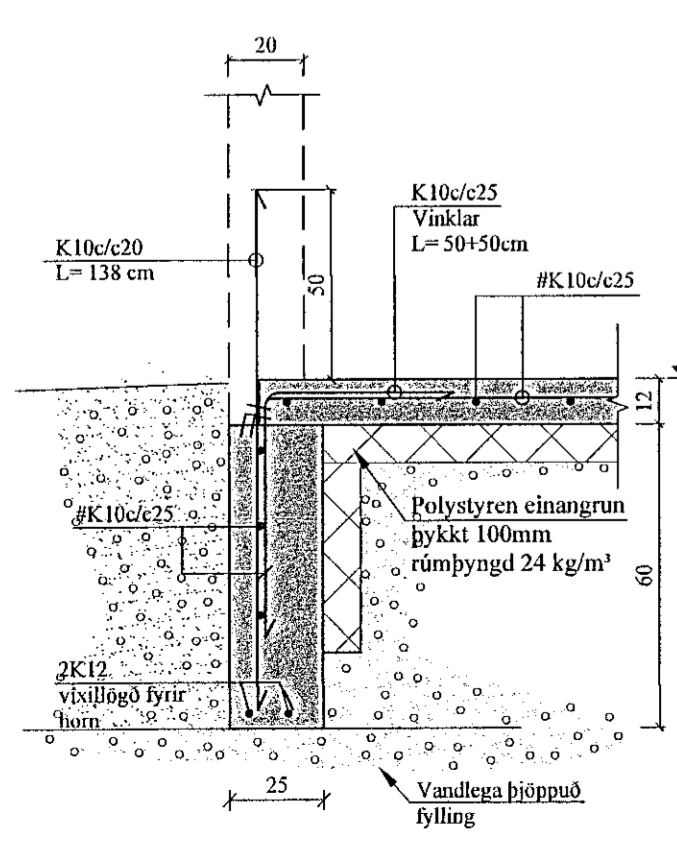

A2' SNIÐ. 1:20

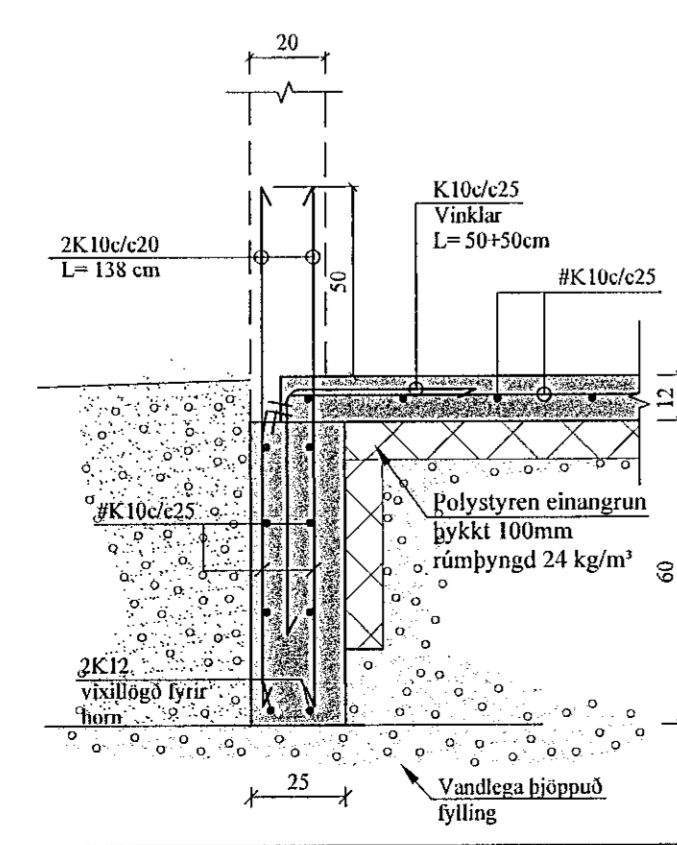

B2 SNIÐ. 1:20

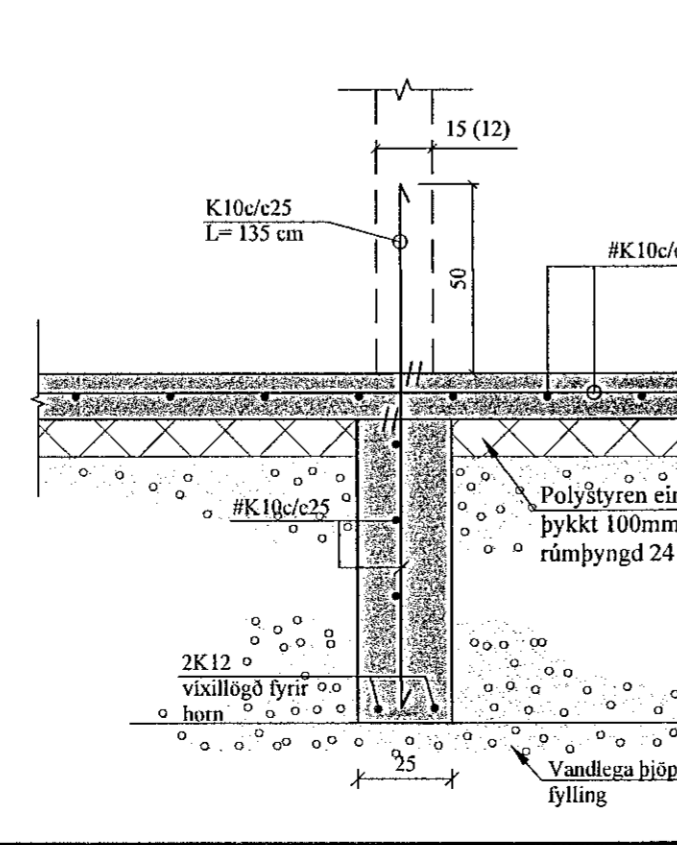

C2 SNIÐ. 1:20 Útveggur

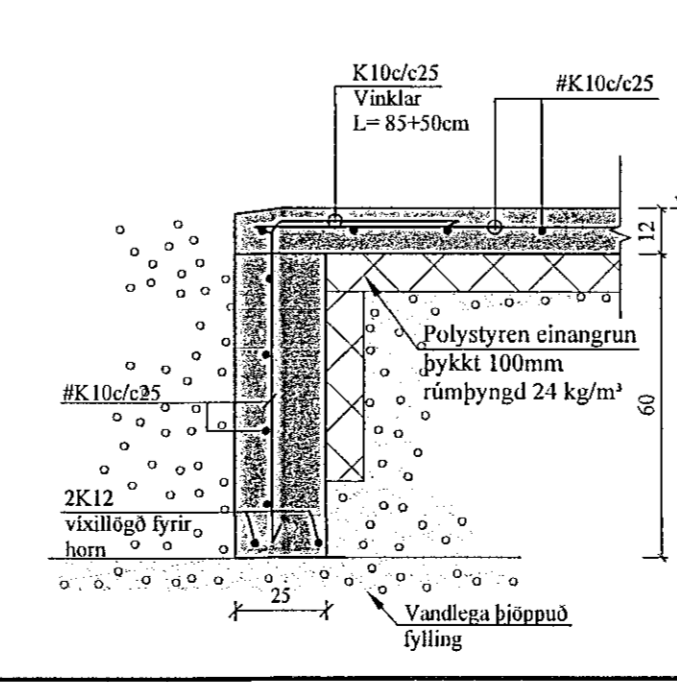

TIL VÍSANIR:

SKÝRINGAR..... SJÁ TEIKN NR. 1-01

ATH:  
VERKTAKA ER HEIMILT AÐ NOTA Í BOTNPLÖTU  
K 257 BENDINET Í STAÐ HEFÐBUNDINNA  
BENDIJÁRNA.

Vanda skal til þjöppunar á fylling  
E2/E1 ≤ 2,3 - E2 ≥ 120 Mpa.

Í VEGGENDA OG UPP MEÐ GLUGGA- OG HURÐA-  
OPUM KOMA 2K12, L = 130 CM.

Reikn.	JKR	Nóv. '21	Útgáfudagur:	28.11.2021
Teikn.	VP	Nóv. '21	Kvarði:	1:50,
Ath.				1:20
Samb.				

**DRANGSSKARÐ 8** Nr. 1-02  
Hafnarfríði

Verkhúti  
UNDIRSTÖÐUR,  
GRUNNMYND OG SNIÐ.

Verkefndastofa  
Jóns Kristjánssonar ehf  
Blásháða 12  
110 Reykjavík  
Sími: 537 4002 Fax: 772 3154  
KE: 540817-0300  
Netfang: jkv654@gmail.com