



Samþykkt þann

13. MAÍ 2022

Byggingarfulltrúinn í Hafgarfirði

*Silvur Björnsson*

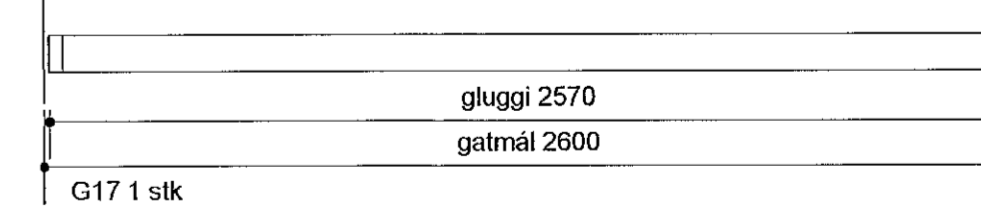
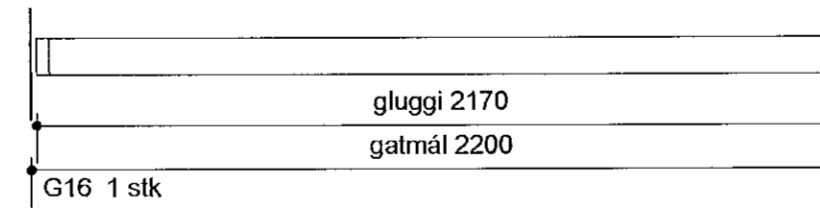
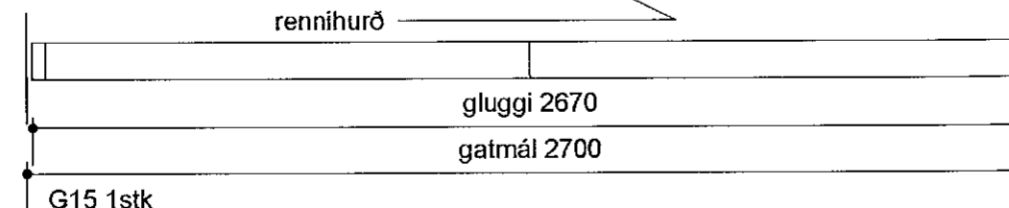
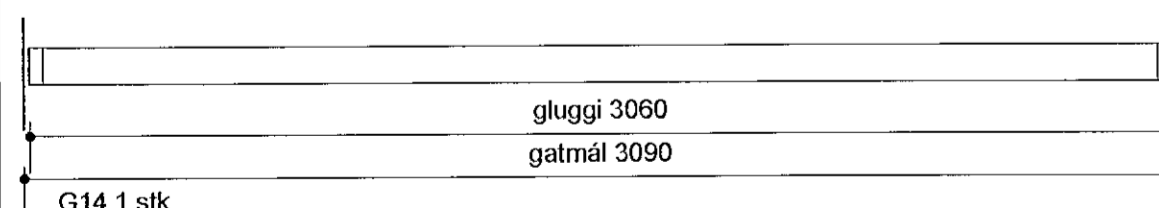
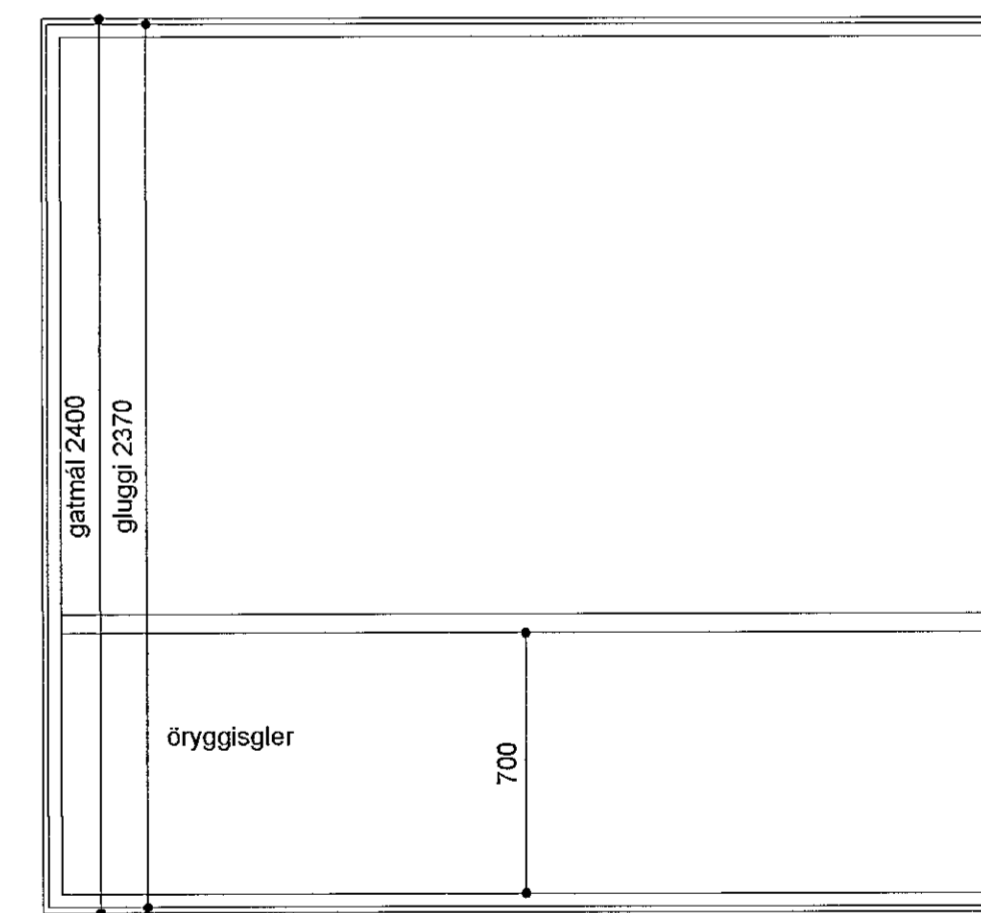
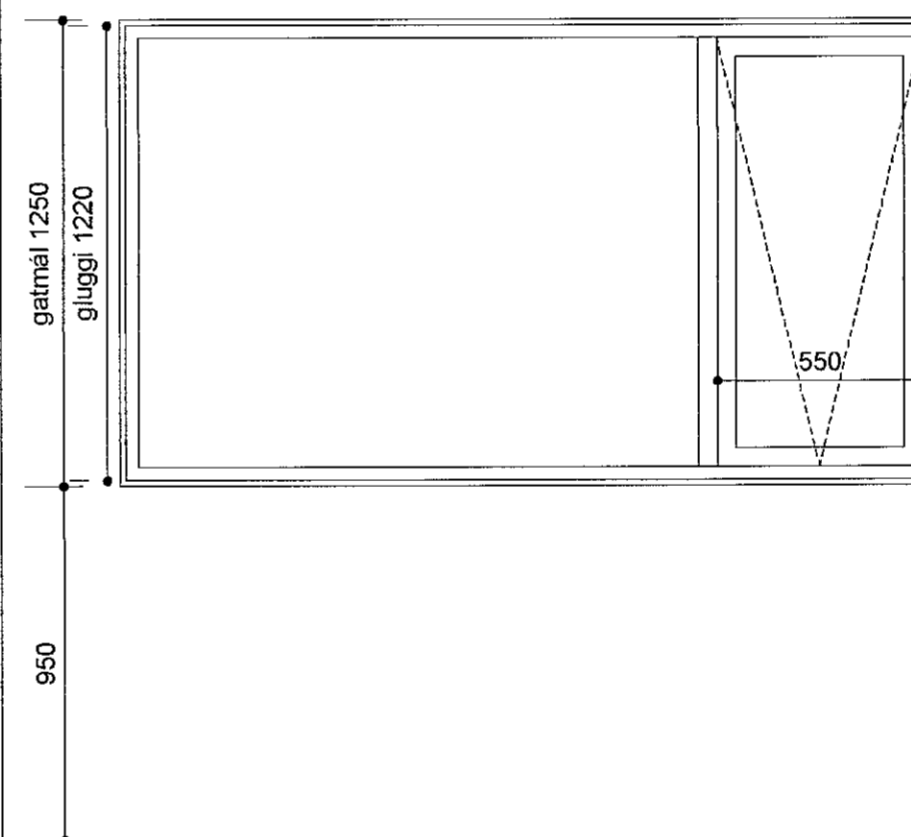
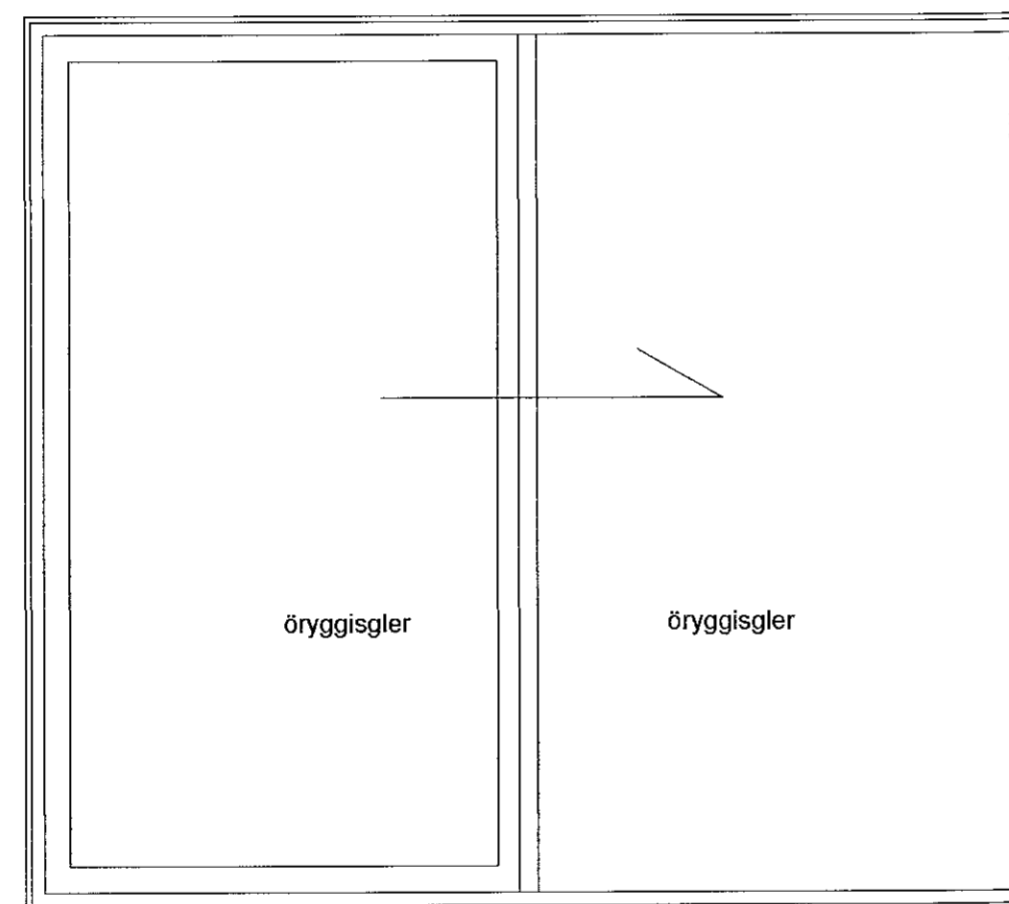
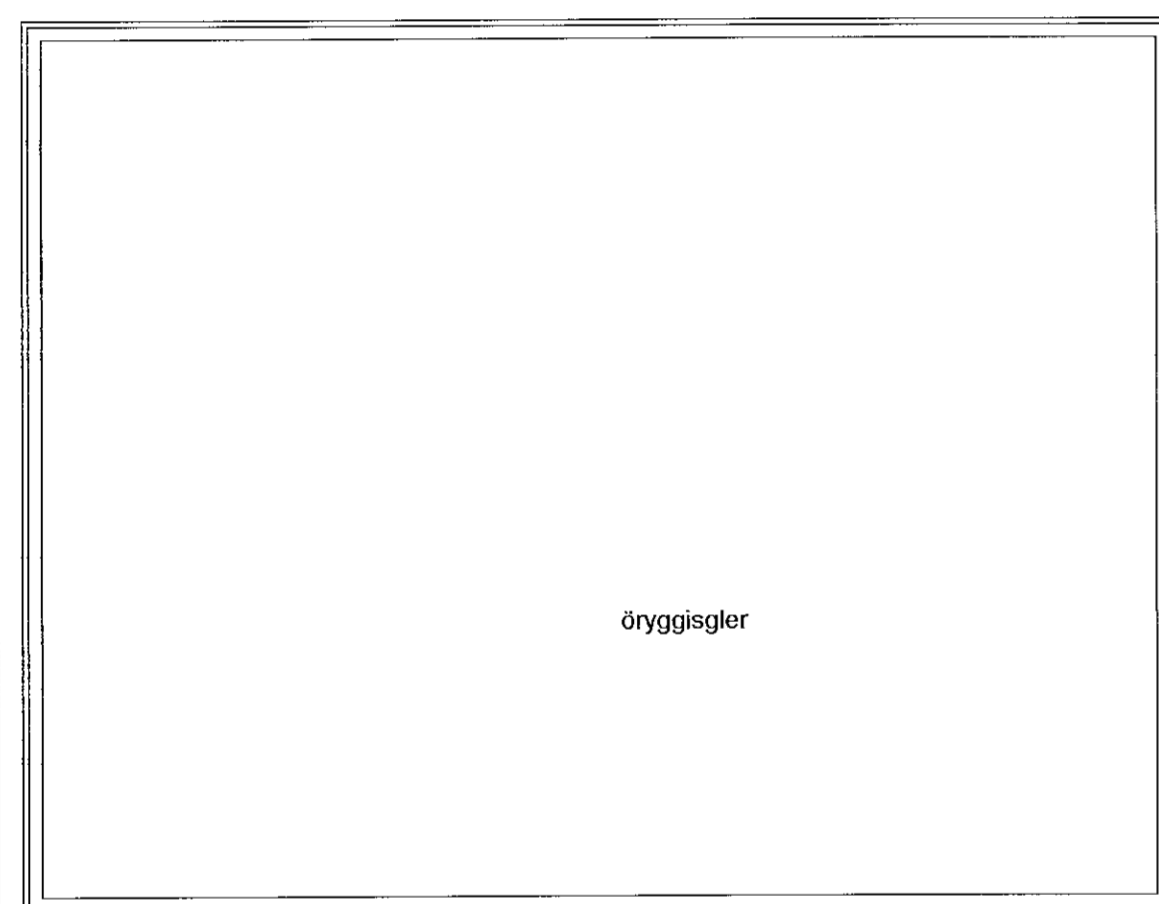
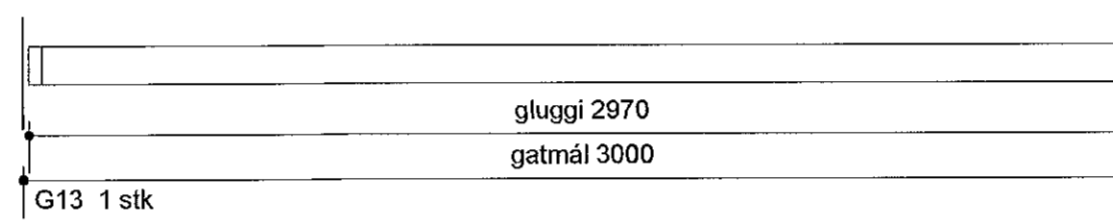
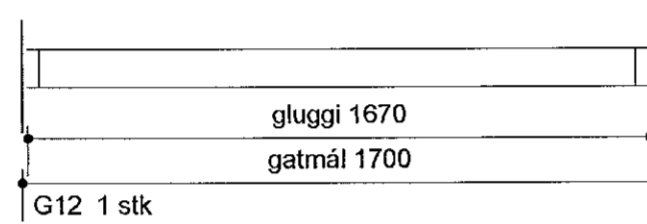
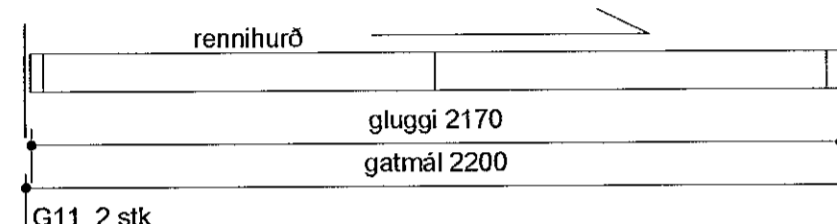
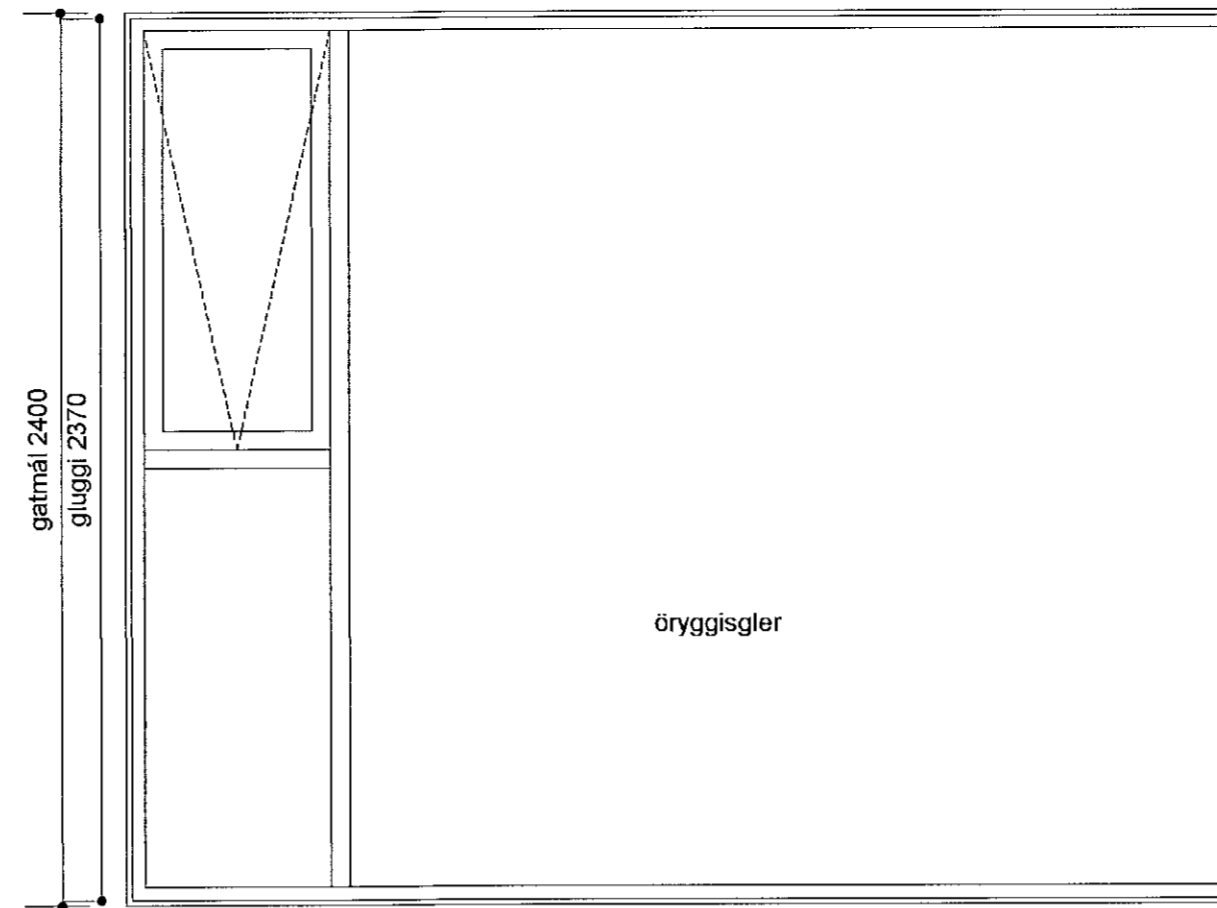
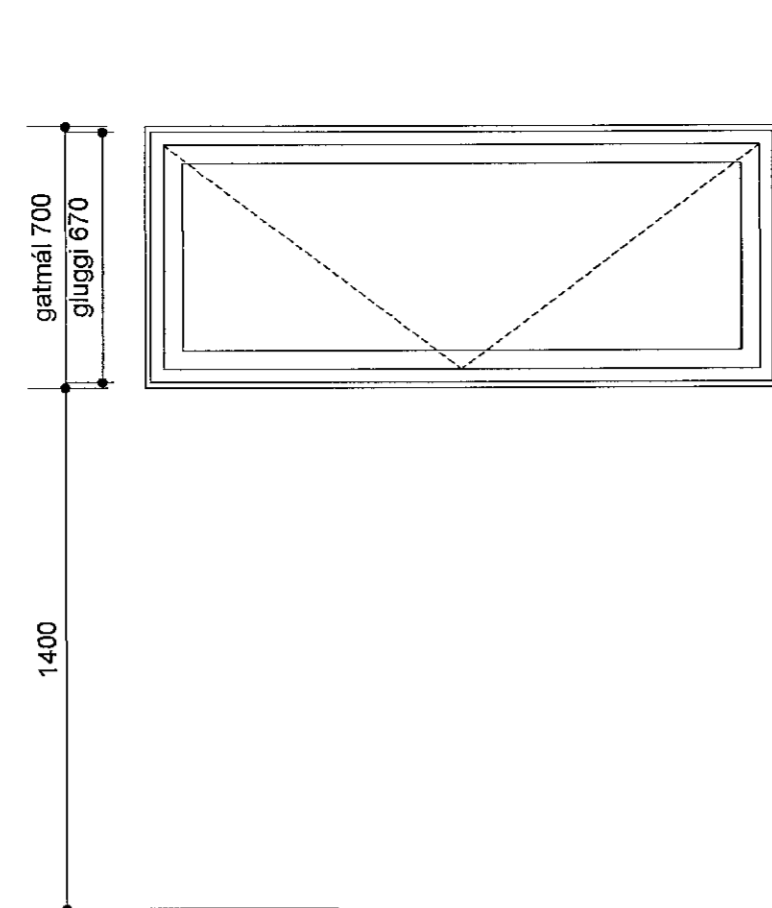
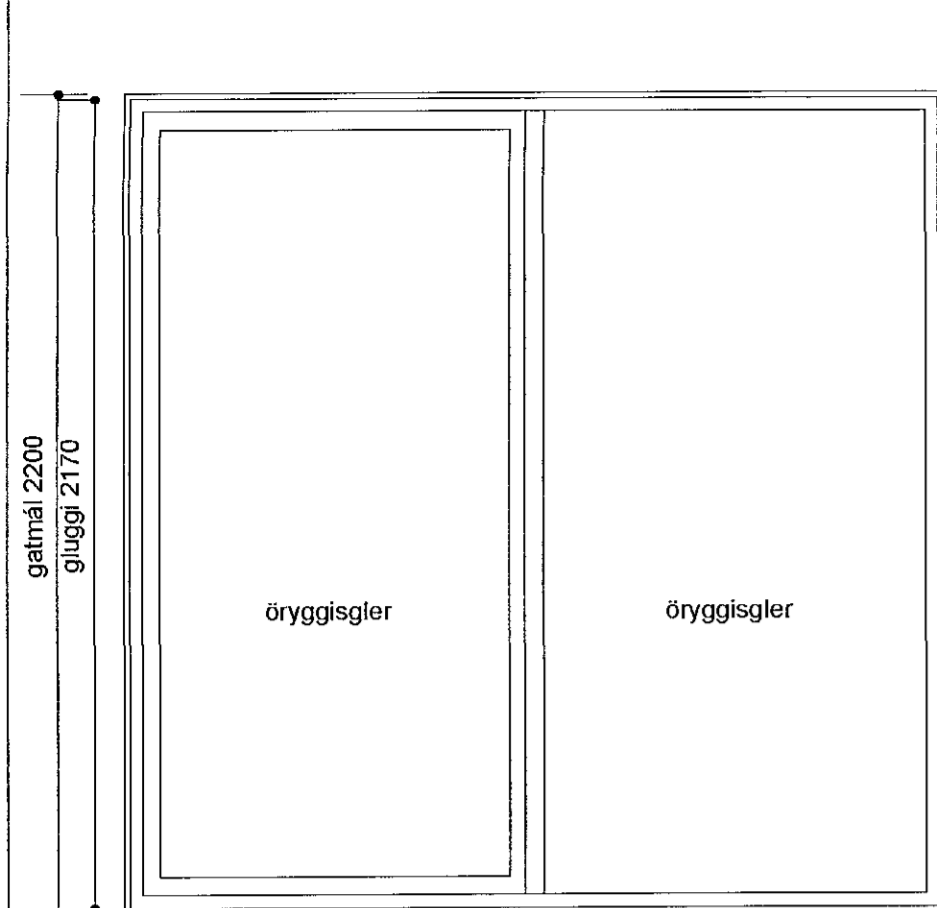

Öll mál staðfærast áður en framkvæmdir hefjast, ósamræmi í teikningum tilkynnist hönnuði strax, öll vafaatriði skal bera undir hönnuð.

Smári Björnsson

SÍMI: 868 1300

NETFANG: smari.bjornsson@gmail.com

kt: 100275 5899

HEITI VERKS:

**BJARGSSKARD 2**

HEITI

TEIKNINGAR: verkeikning

gluggar

MKV:

1/20

DAGS:

04.03.22

NR. TEIKN

A2 10

UNDIRSKR. HÖNNUÐAR

ÚTGÁFA

*[Signature]*