

A3 SNID. 1:20
1-03

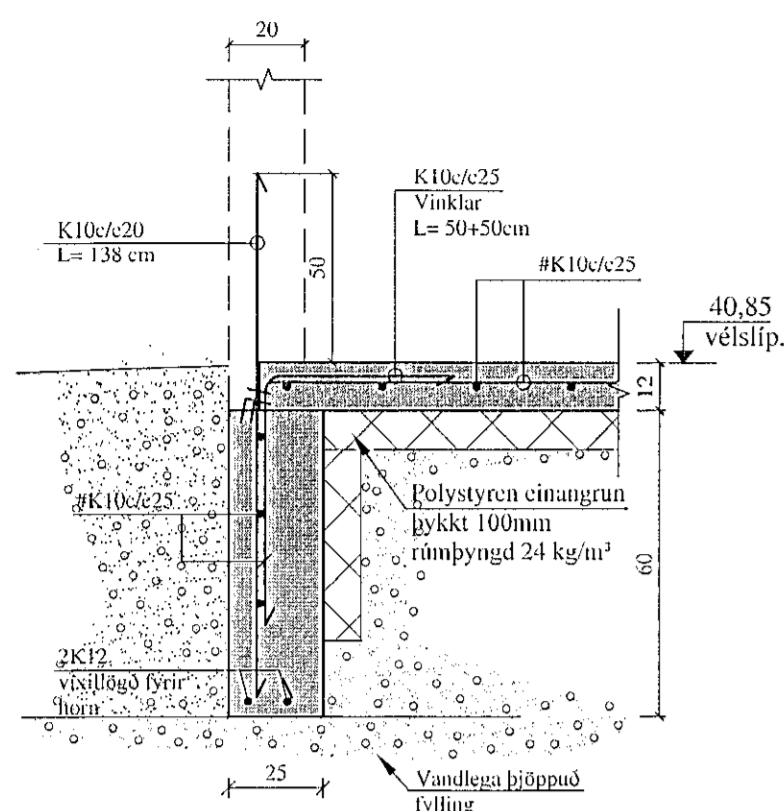

E3 SNID. 1:20
1-03

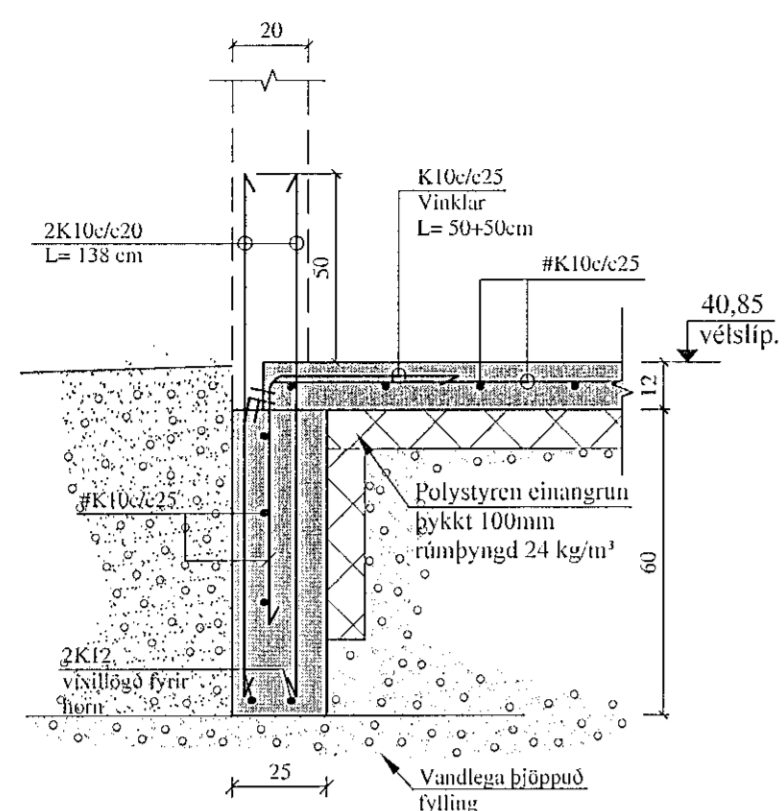

B3 SNID. 1:20
1-03

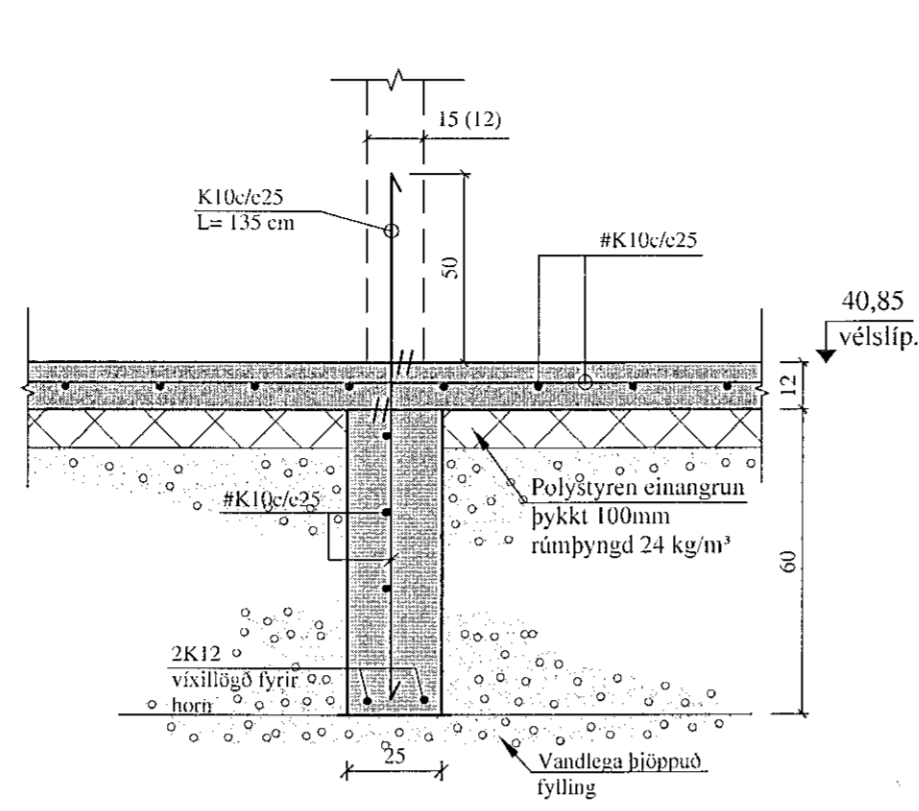

C3 SNID. 1:20
1-03 Útveggur

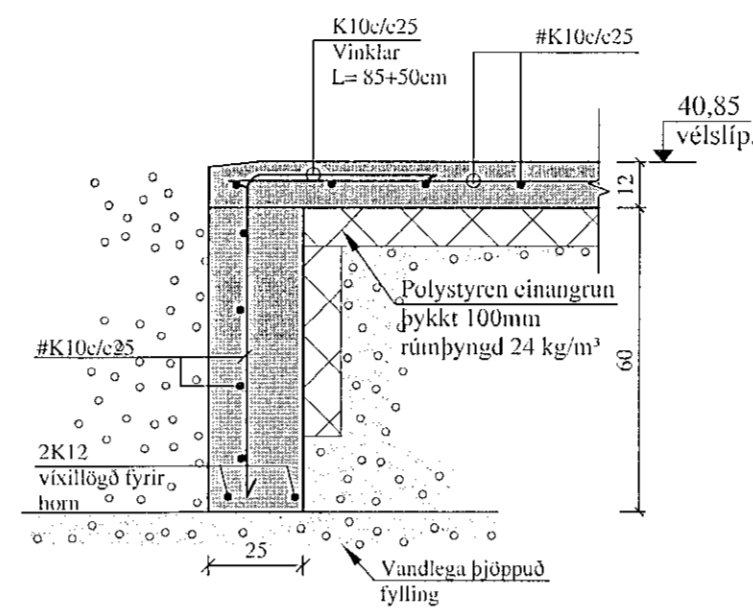

D3 SNID. 1:20
1-03 Stigi

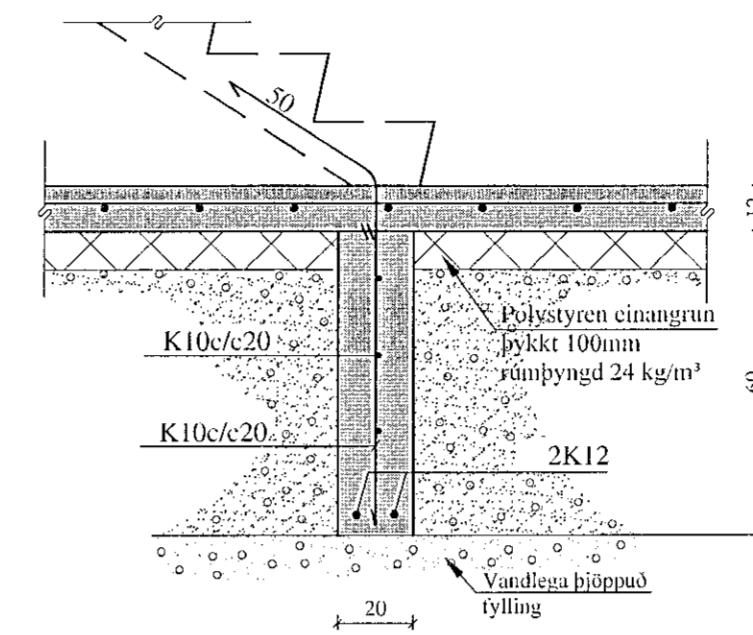

S1 SÚLA. 1:20
1-02

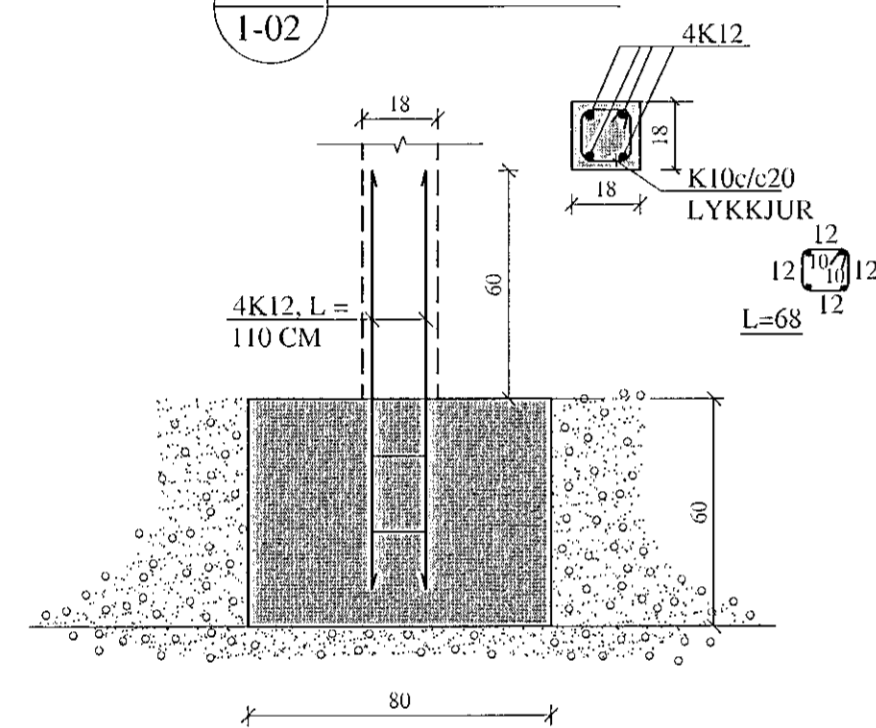

GÖT Í UNDIRSTÖÐUR:

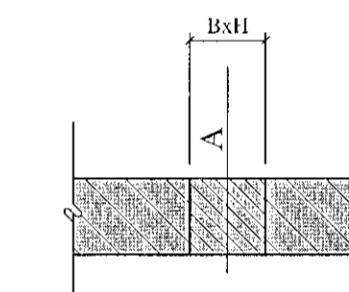

A = KÓTI Á NEDRI BRÚN GATS
B = BREIDD GATS
H = HÆÐ GATS

JÓN KRISTJÁNSSON BYGGINGARVERKFRÆÐINGUR
KT: 210754-4829

BREYTINGAR

TILVÍSANIR:

SKÝRINGAR..... SJÁ TEIKN. NR. 1-01

ATH:
VERKTAKA ER HEIMILT AD NOTA Í BOTNPLÖTU
K 257 BENDINET Í STAD HEFÐBUN.DINNA
BENDUÁRNA.

Vanda skal til þjöppunar á fyllingu!
E2/E1 ≤ 2,3 - E2 ≥ 120 Mpa.

Í VEGGENDA OG UPP MED GLUGGA- OG HURDA-
ÖPUM KOMA 2K12, L = 130 CM.

Reikn.	JKR	Apríl '22	Útgeft:	20.05.2022
Teikn.	VP	Apríl '22	Kvarði:	1:20
Alb.				
Samþ.				

BJARGSSKARÐ 1 Nr. 1-03
Hafnarfirði

Verkhlu ti
UNDIRSTÖÐUR,
GRUNNMYND OG SNID.

VerkfraeStofa
Jóns Kristjánssonar v.1.f
Síðenduráka 12
110 Reykjavík
Síni: 537-0202 Fax: 3154
Rt: 540817-02 a
Netfang: jkr@54@r-mail.com