

Samþykkt þann  
09. 2022  
Byggingafrúðunin í Hafnarhöfði

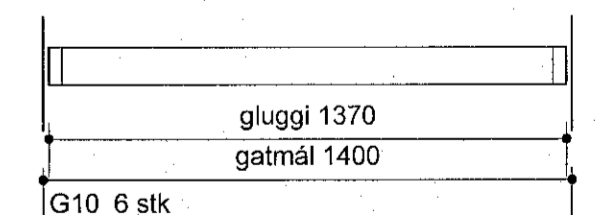
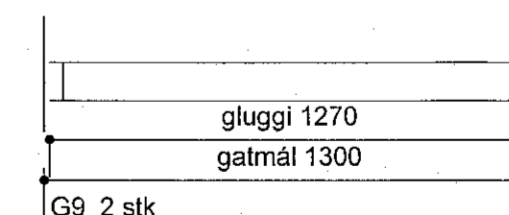
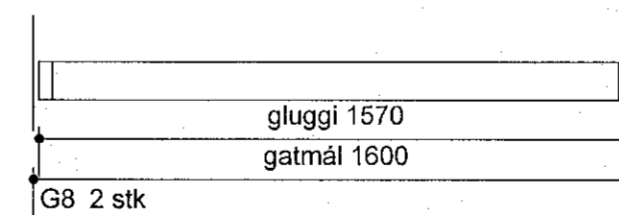
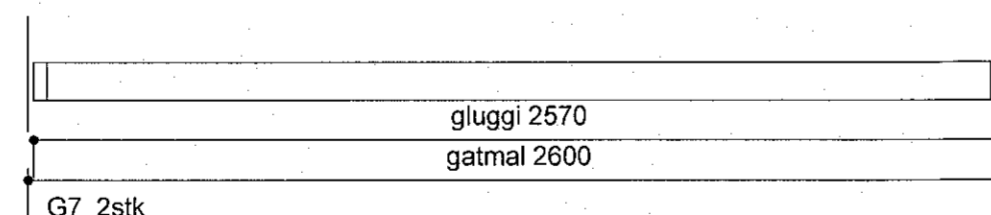
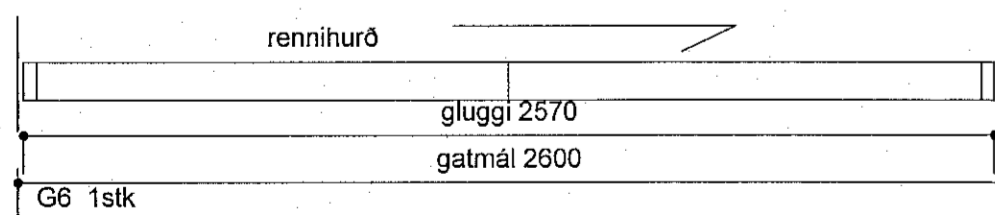
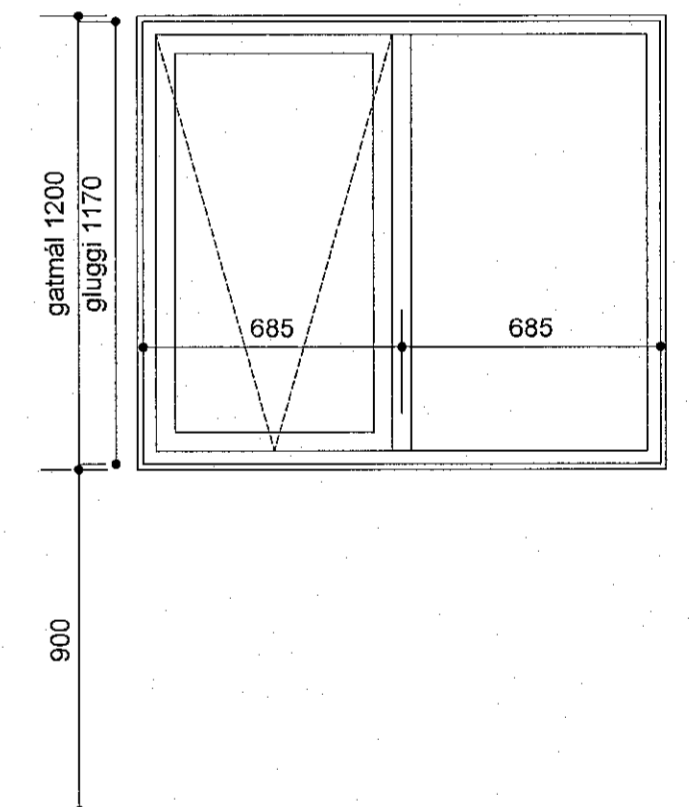
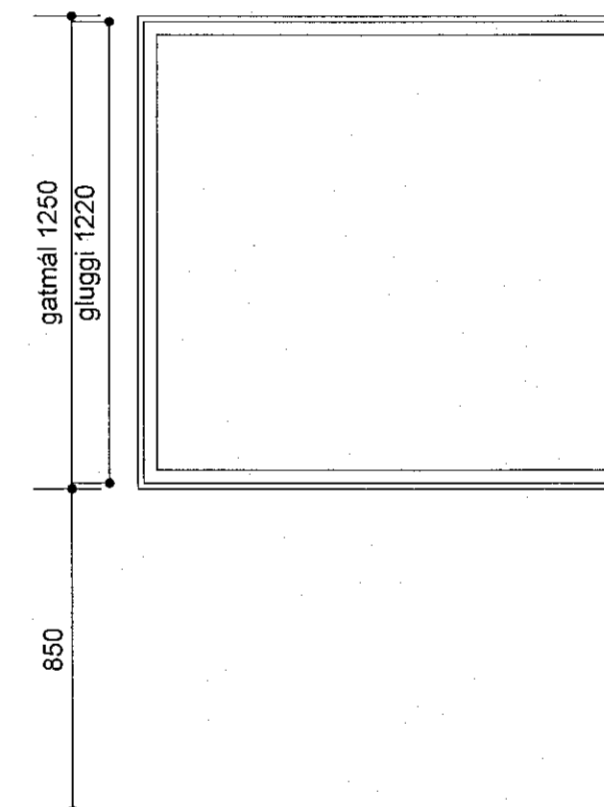
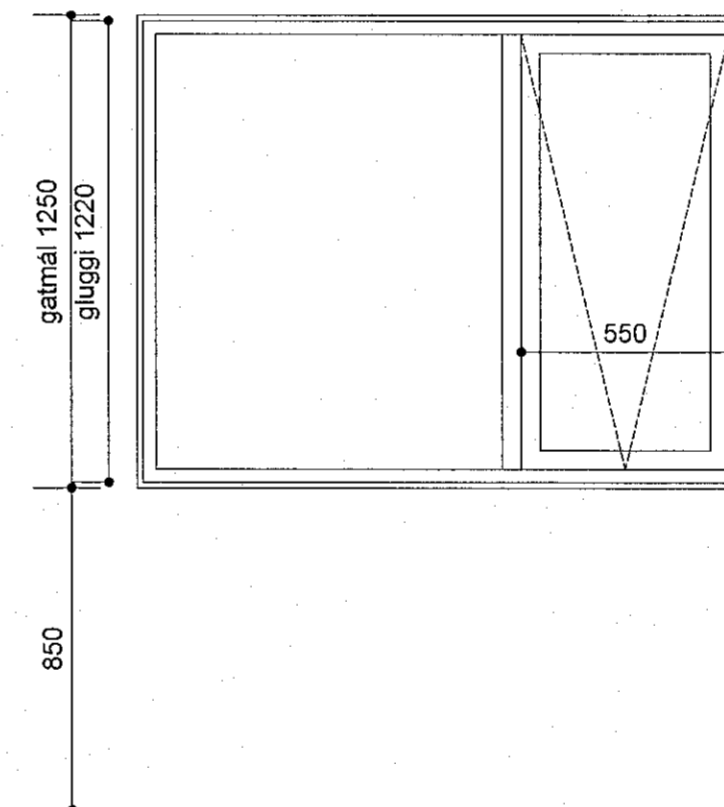
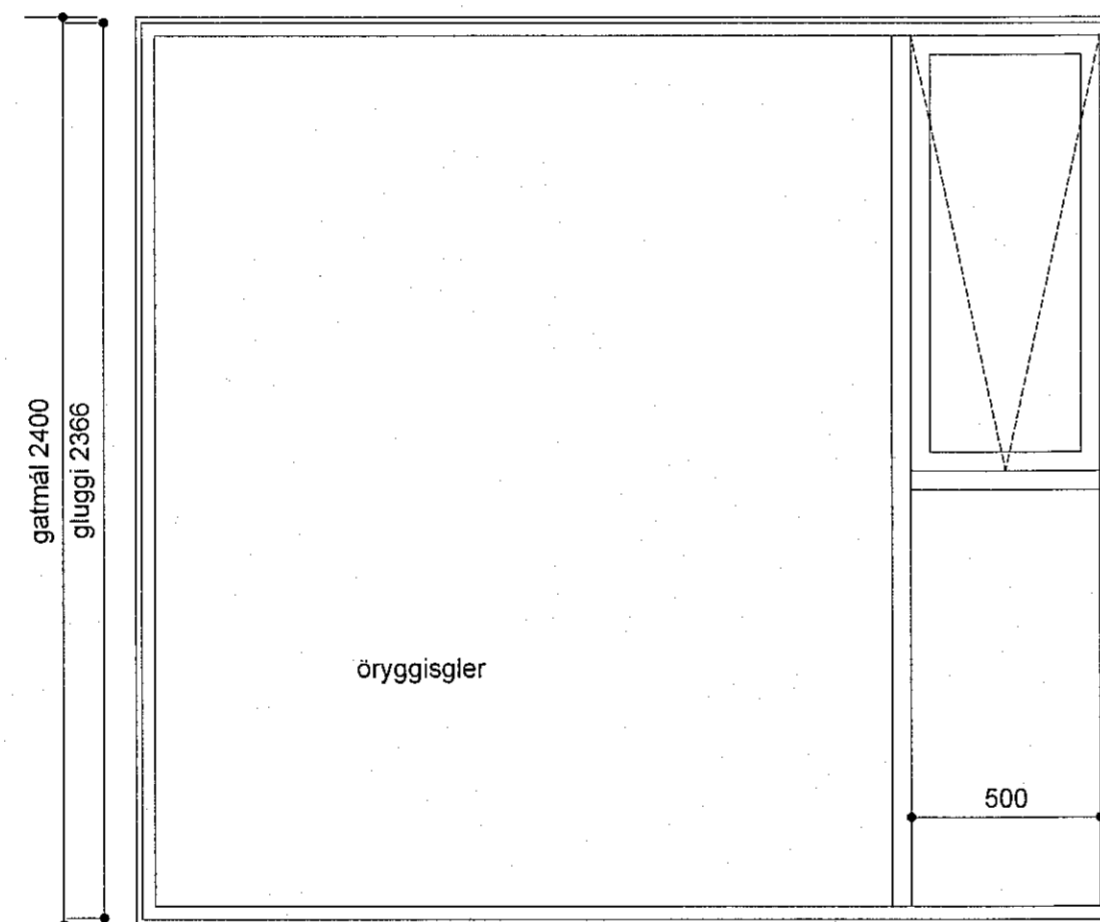
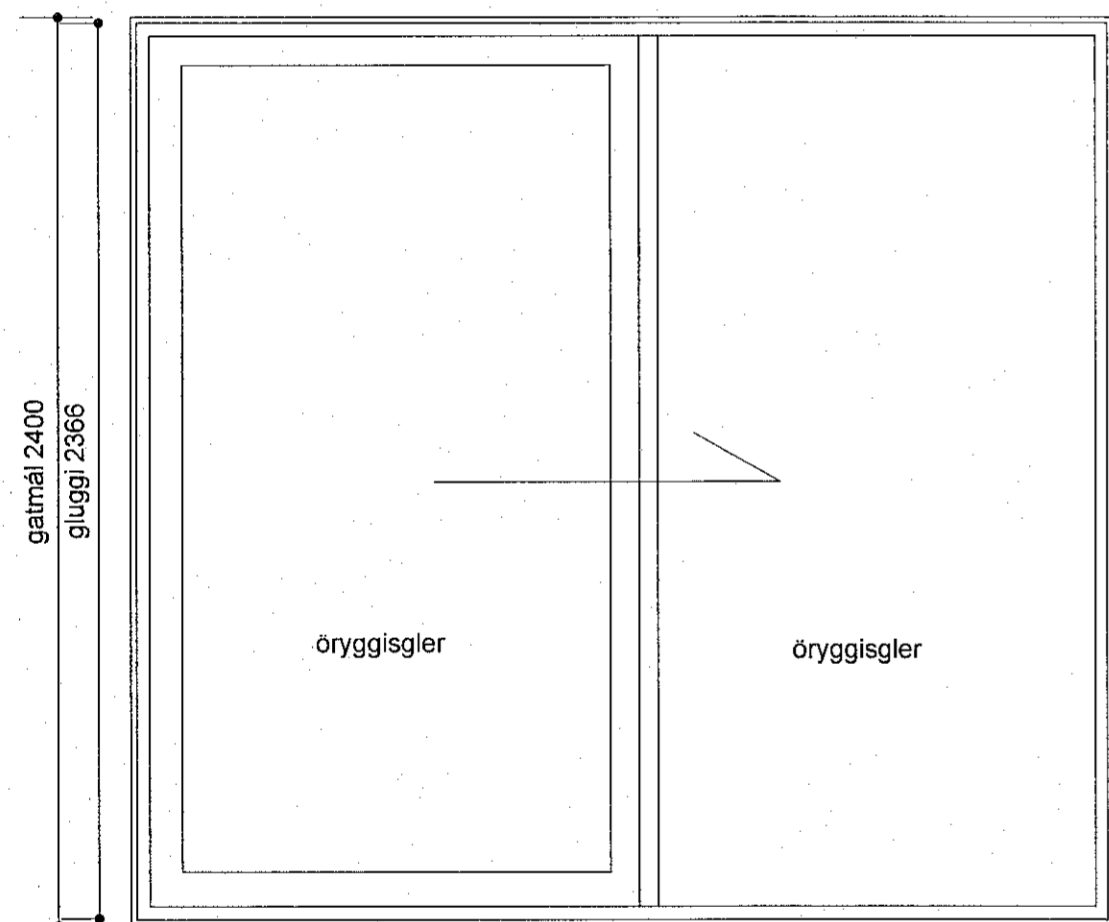

Öll mál staðfærast áður en framkvæmdir hefjast, ósamræmi í teikningum tilkynnist hönnuði strax, öll vafaatriði skal bera undir hönnuð.

<b>Smári Björnsson</b>		
SÍMI: 868 1300 NETFANG: smari.bjornsson@gmail.com kt: 100275 5899		
HEITI VERKS: <b>BJARGSSKARD 2</b>		
HEITI TEIKNINGAR: <b>verkteikning</b>		
<b>gluggar</b>		
MKV: 1/20	DAGS: 04.03.22	NR. TEIKN A2 9
UNDIRSKR. HÖNNUÐAR		ÚTGÁFA