

IV-001

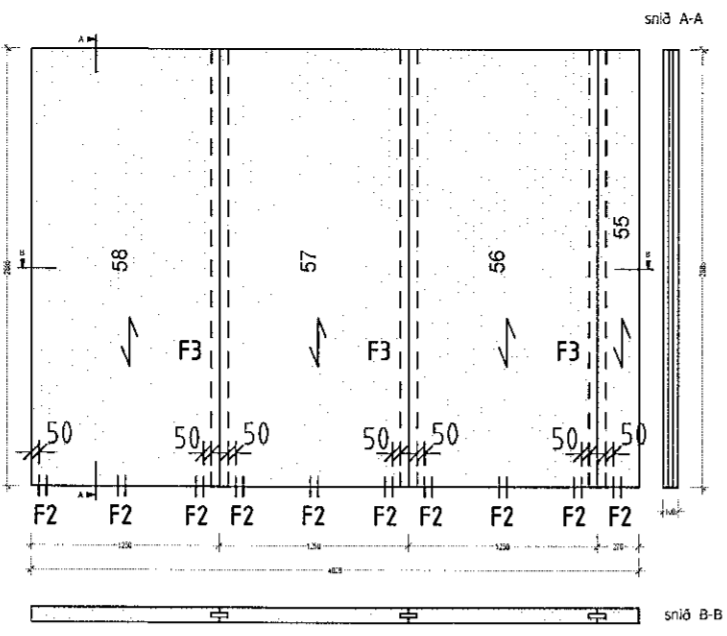

IV-002

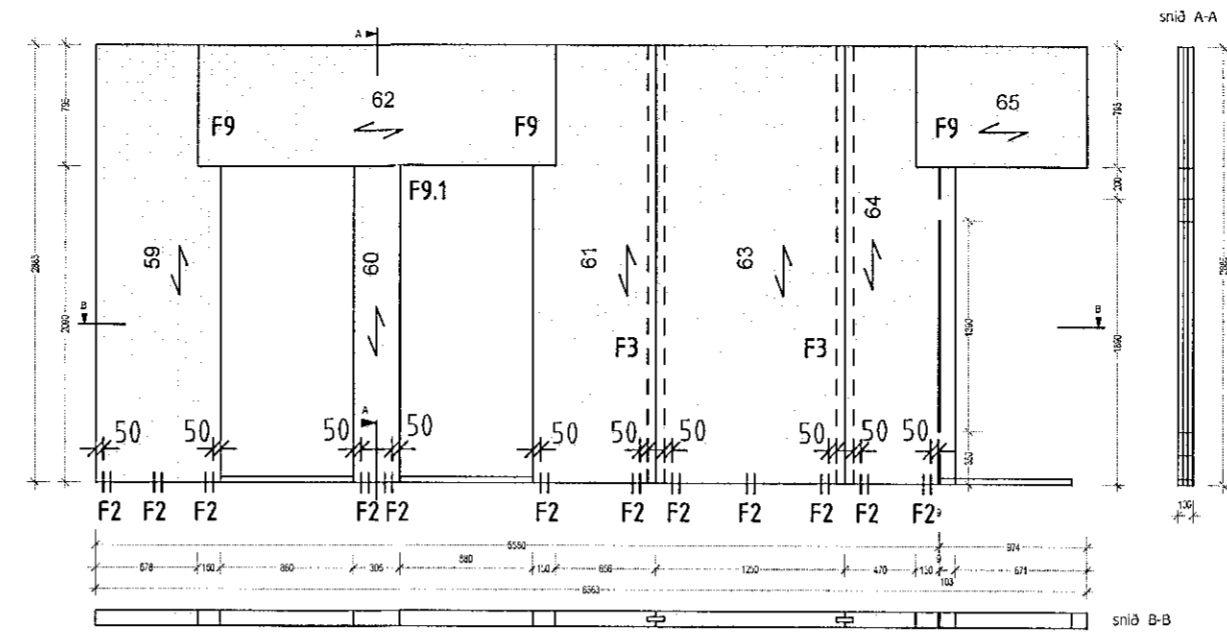

IV-003

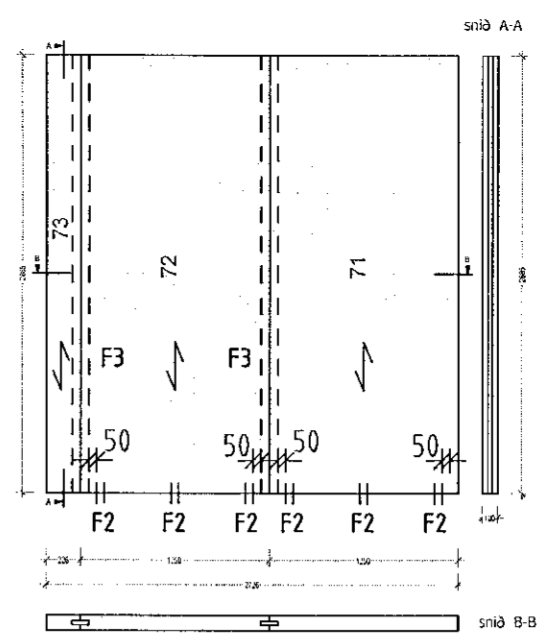

IV-005

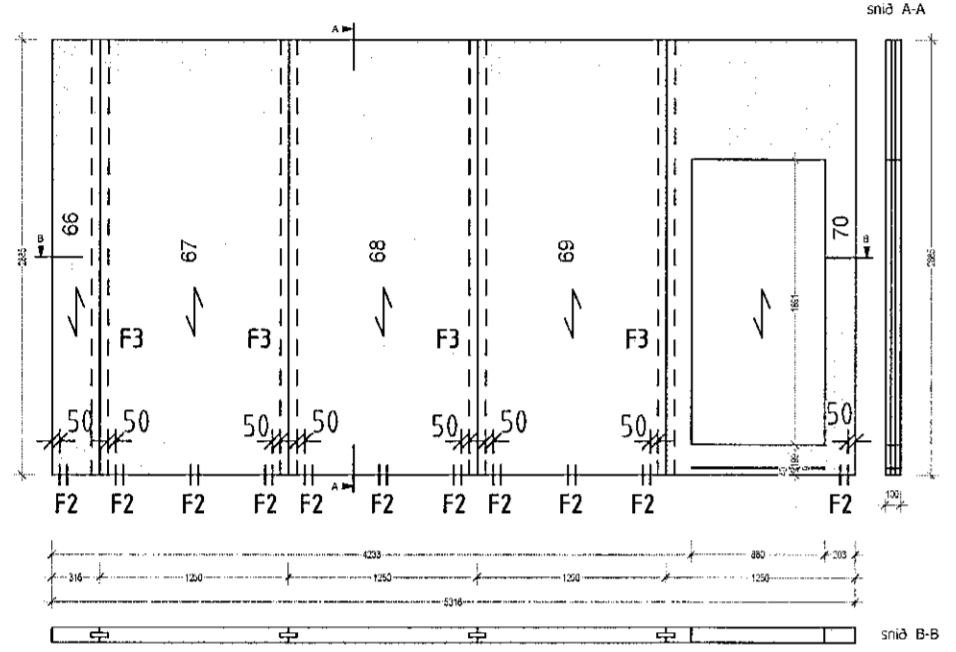

IV-004

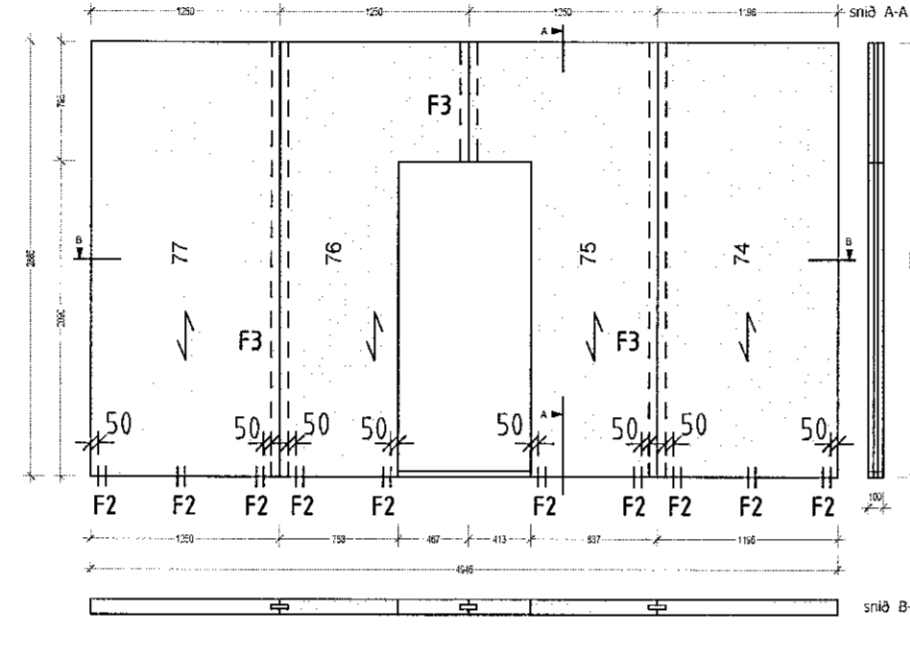

IV-006

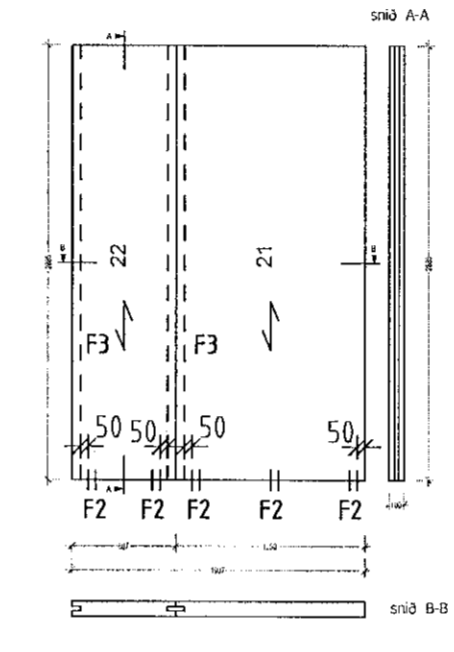

IV-007

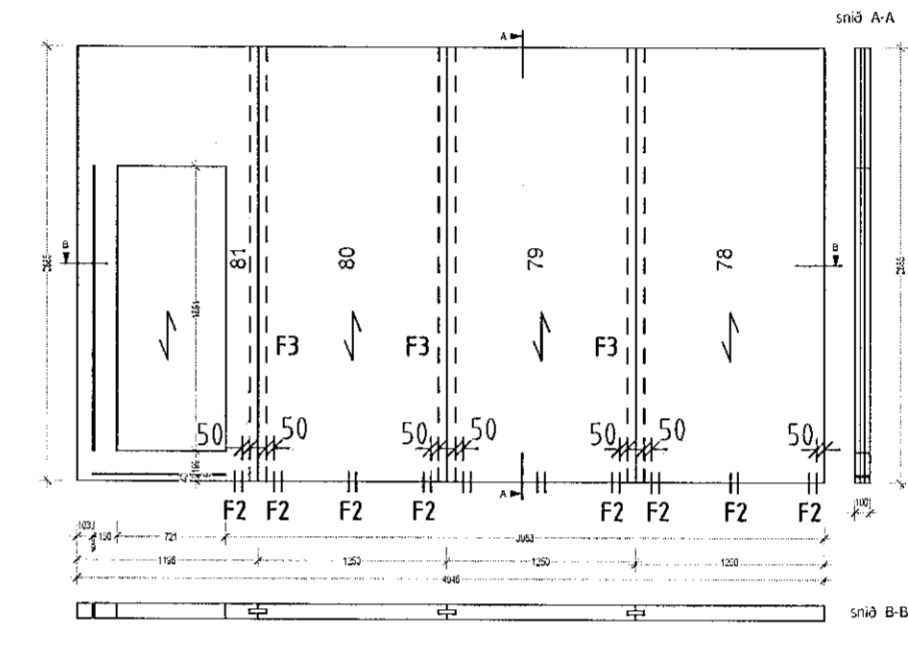

IV-008

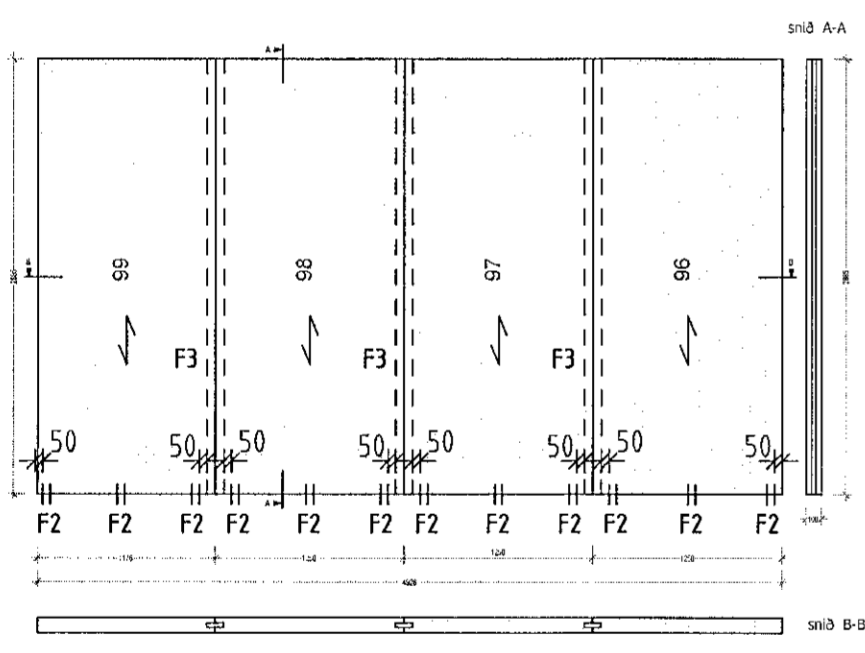

IV-009

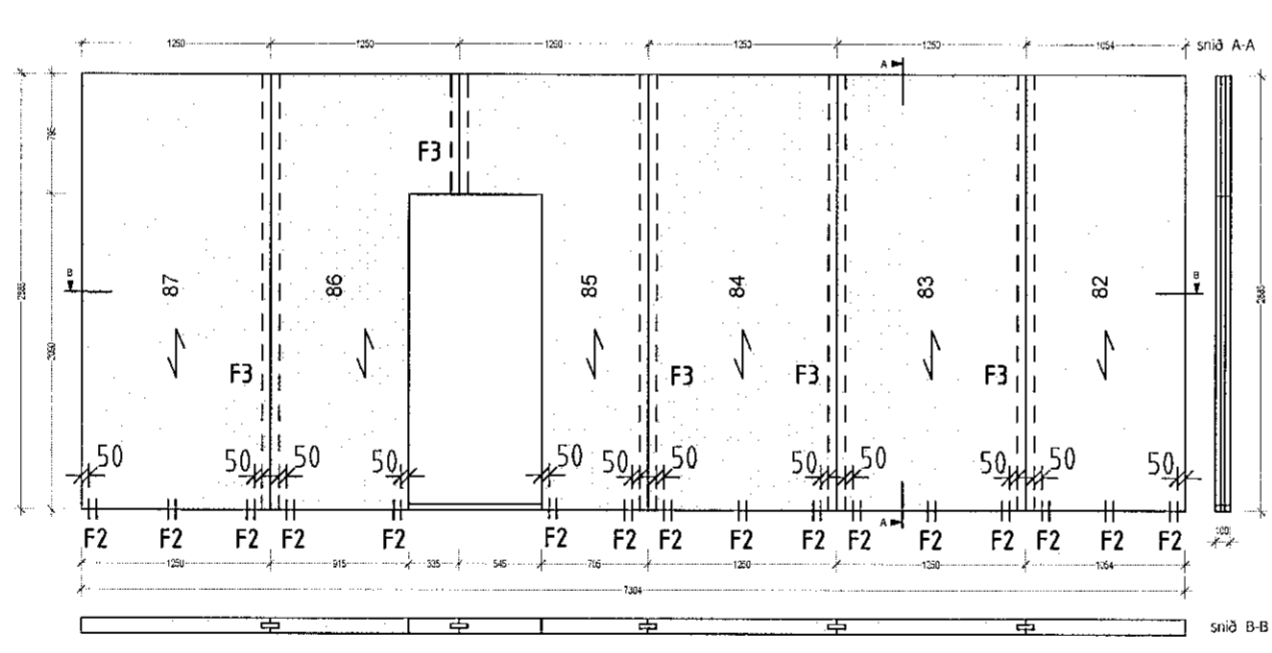

IV-010

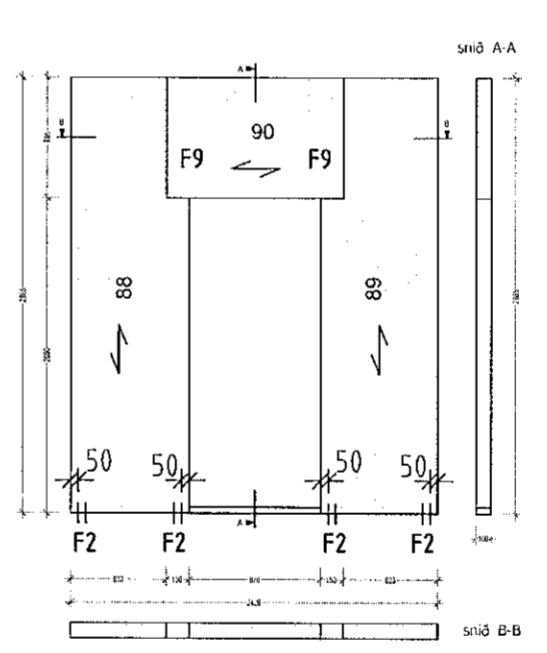

IV-011

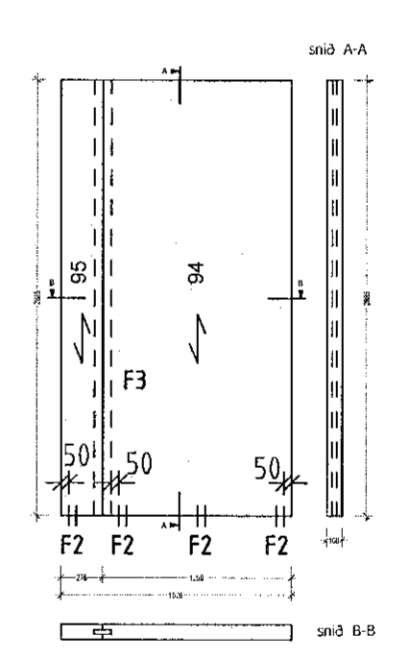

IV-012

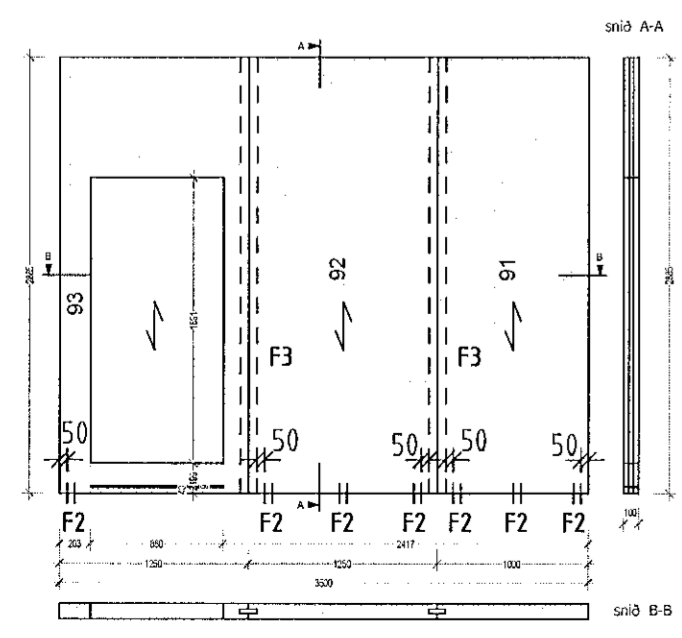

IV-013

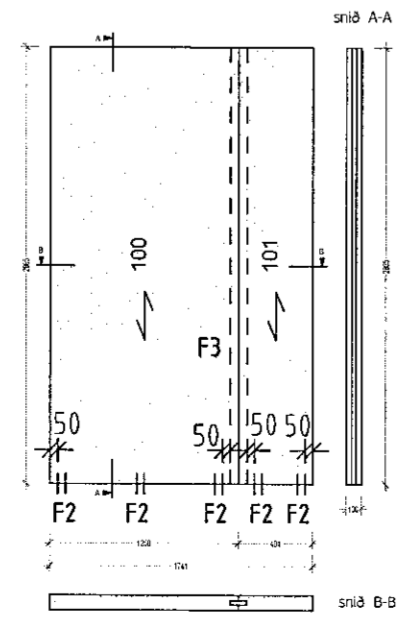

IV-014

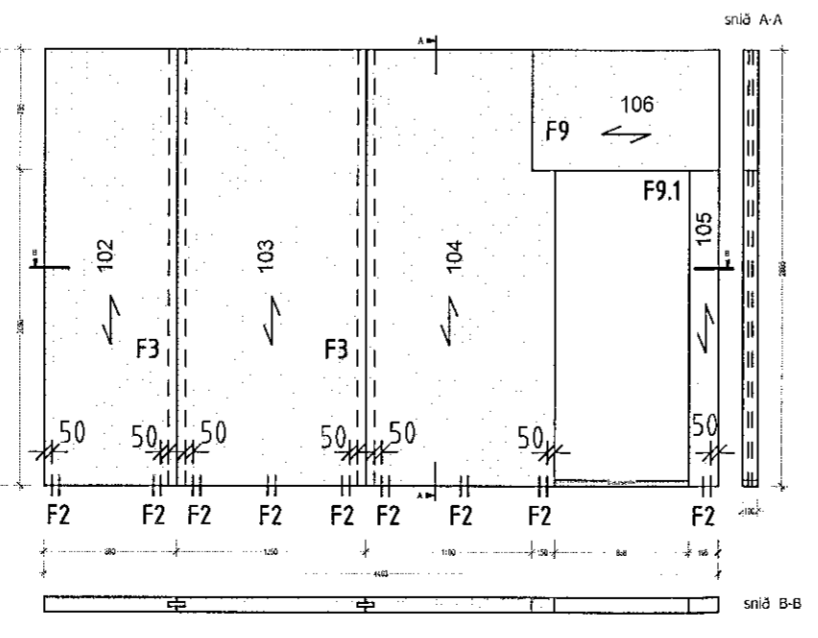

IV-015

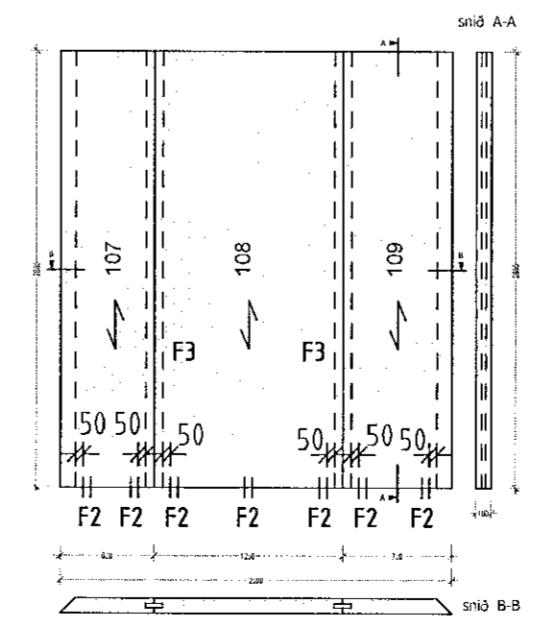

IV-016

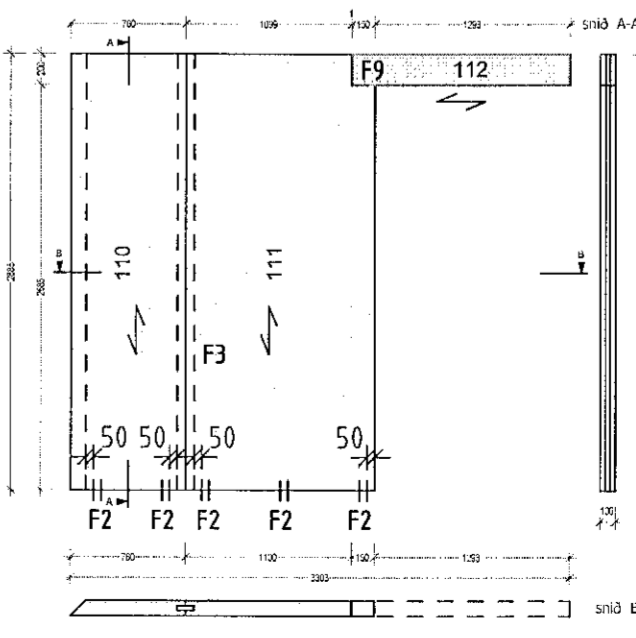

IV-017

Samþykkt þann
09. sep. 2021
i.h. byggingarfulltrúans í Hafnarfirði
Hjálmar A. Jónsson
HJA

NR.	DAGS.	BREYTING

SKÝRINGAR

SKÝRINGAR SJÁ TEIKN B001
ÖLL MÁL A TEIKNINGU Í MILLIMETRUM
EKKI SKAL MÆLA UPPI AF TEIKNINGUM
ÖNNUR MÁL OG ALLUR ANNAR FRÁGANUR
SJÁ TEIKNINGAR AÐALHÖNNUÐAR
VEGGEININGAR SJÁ TEIKNINGAR B005, B006,
B009, B010, B011-B014
ÞAK- OG GÓLFEININGAR SJÁ TEIKNINGAR B007 OG B009
FESTINGAR OG SAMSETNING Á EININGUM SJÁ
SÉRMYNDIR TEIKNINGAR B020 - B021
VIÐ UPPSETNINGU VEGGEININGA ER ÞÆR STILLAR AF
MEÐ ÞVI AÐ SKÁSTIKKA MEÐ SKRÚFUM VGZ M7x220 mm.

24/8'21
AÐALHÖNNUÐUR OG BURÐARÞOLSHÖNNUÐUR
SÆMUNDUR EIRÍKSSON 261249-2949

VÖLUSKARÐ 26
220 HAFNARFJÖRÐUR



KLÖPP ARKITEKTAR-VERKFRÆÐINGAR EHF
NJARDARHOLT 3 270 MOSFELLSBÆR
SÍMI 577 2277, 699 7747 - klop@simnet.is

HEITI TEIKN.	VEGGEININGAR ÚTLIT INNVEGGIR 1. hæð		
MÆLIKVARÐI	150	DAGS.	JÚLÍ 2021
TEIKNING	B 013	VERK	V 21-301
BREYTING		YFIRFARID	SE