

D-13- Lárétt
2.01-13

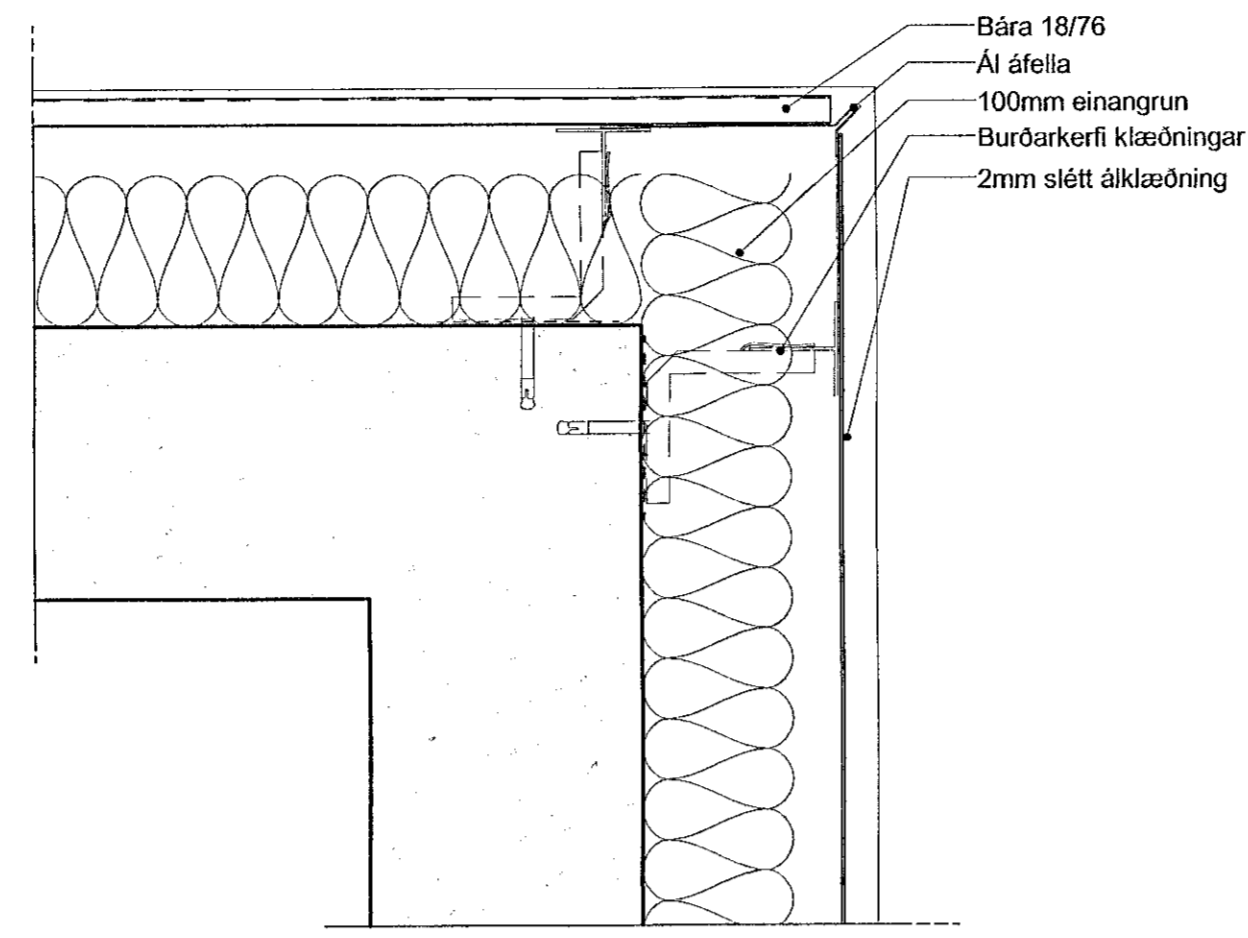

D-14- Lárétt
2.01-12

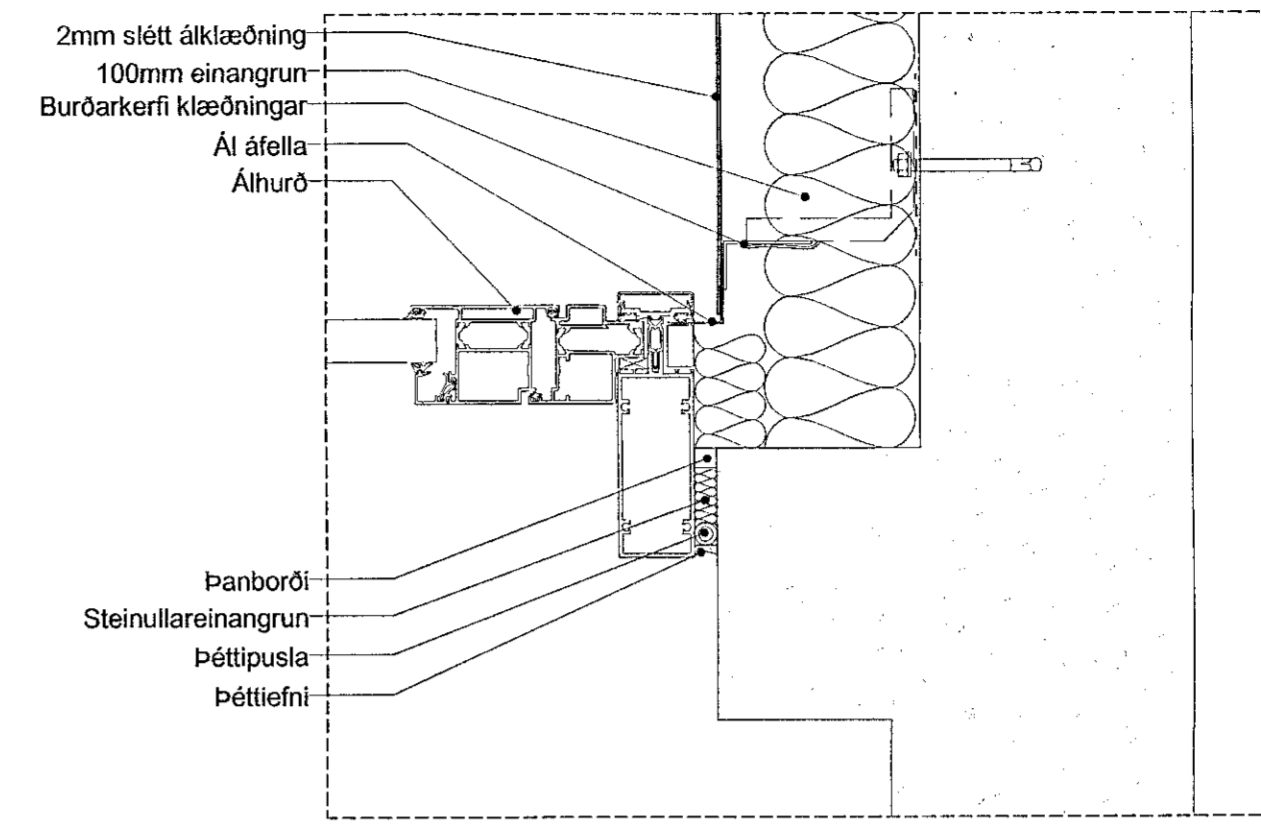

D-15- Lárétt
2.01-12

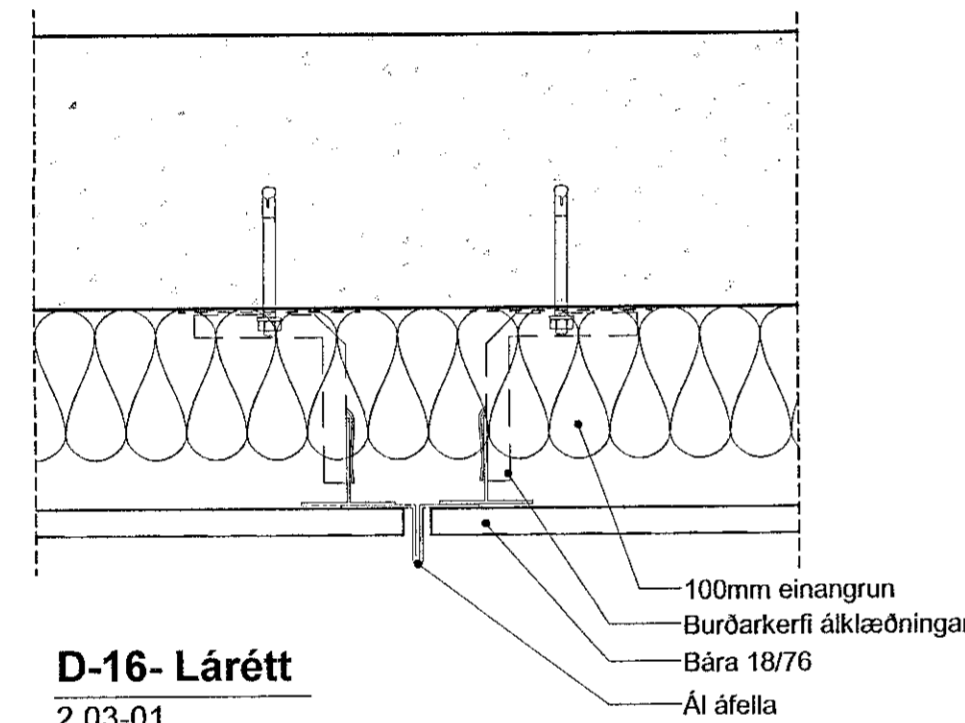

D-16- Lárétt
2.03-01

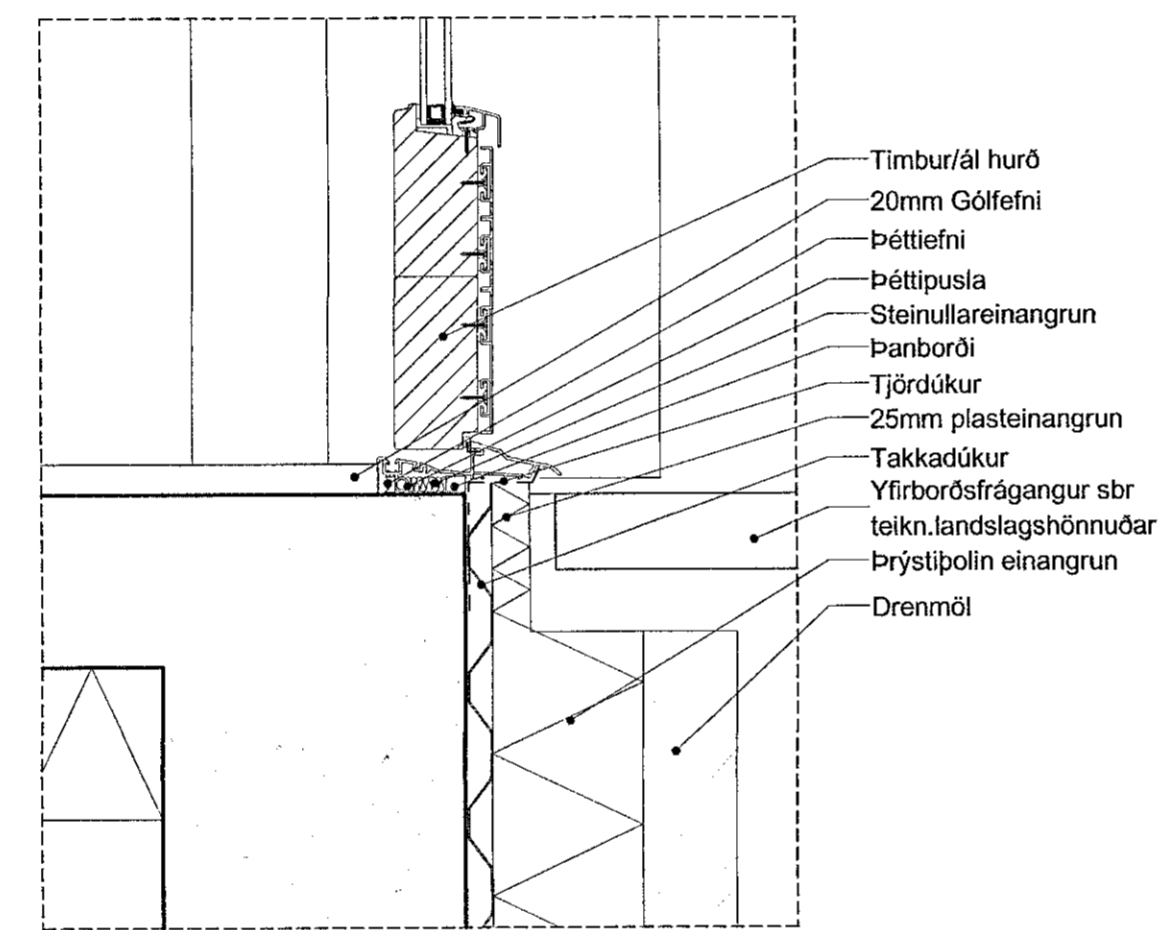

D-17- Lóðrétt
2.01-11

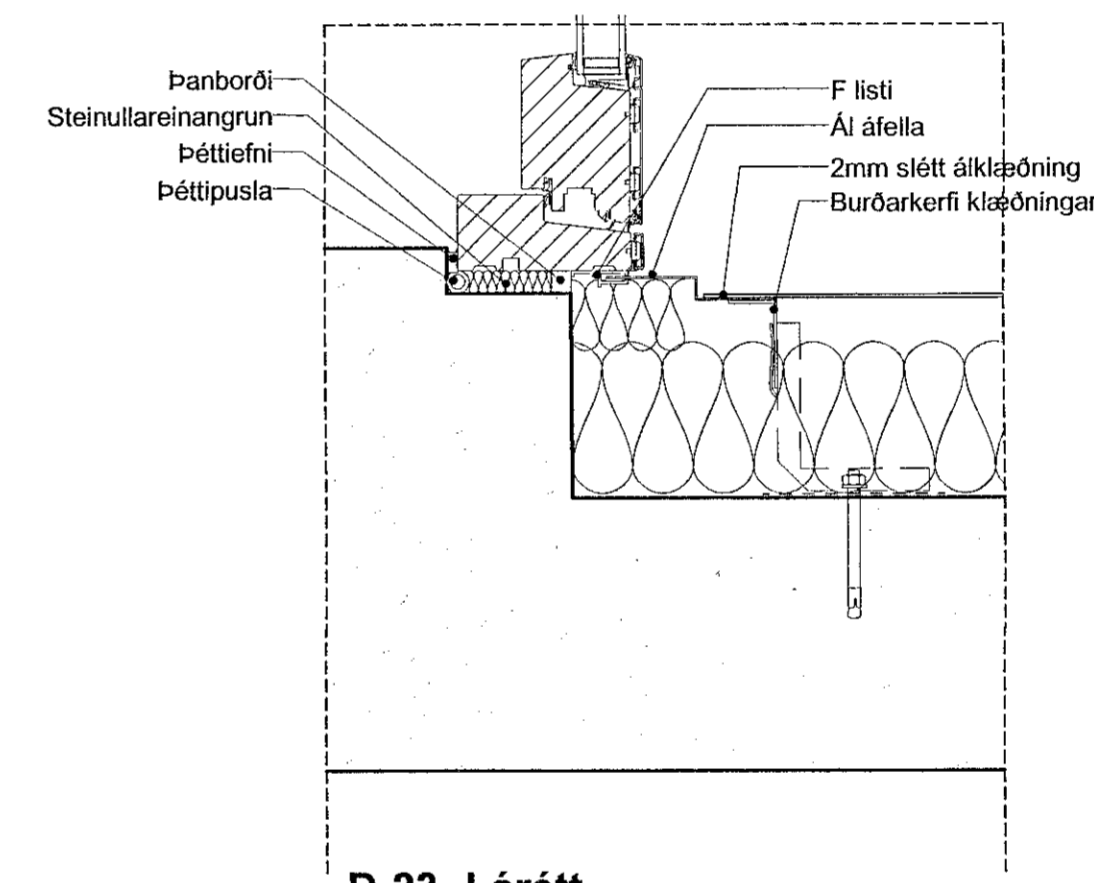

D-23- Lárétt
2.01-12

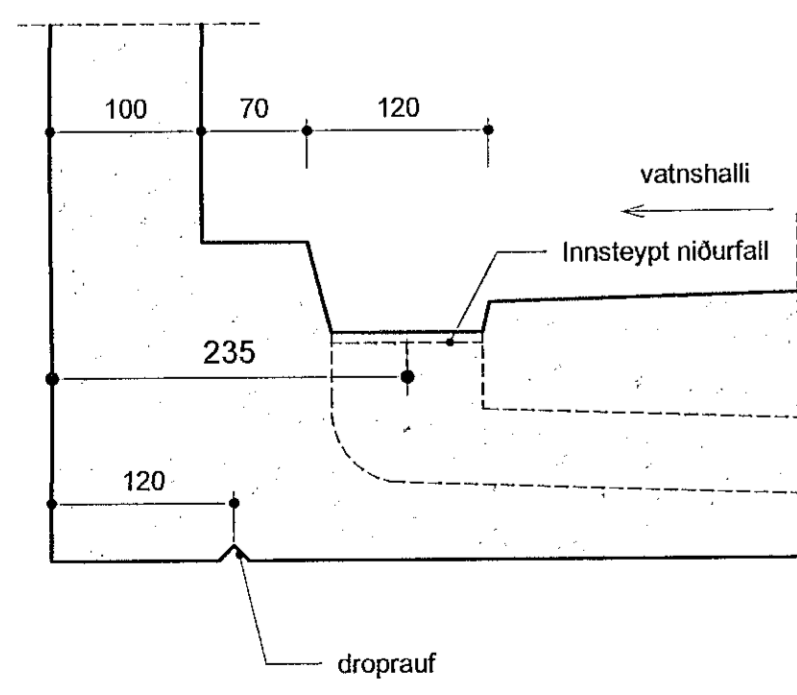

D-21- Lóðrétt
2.05-20

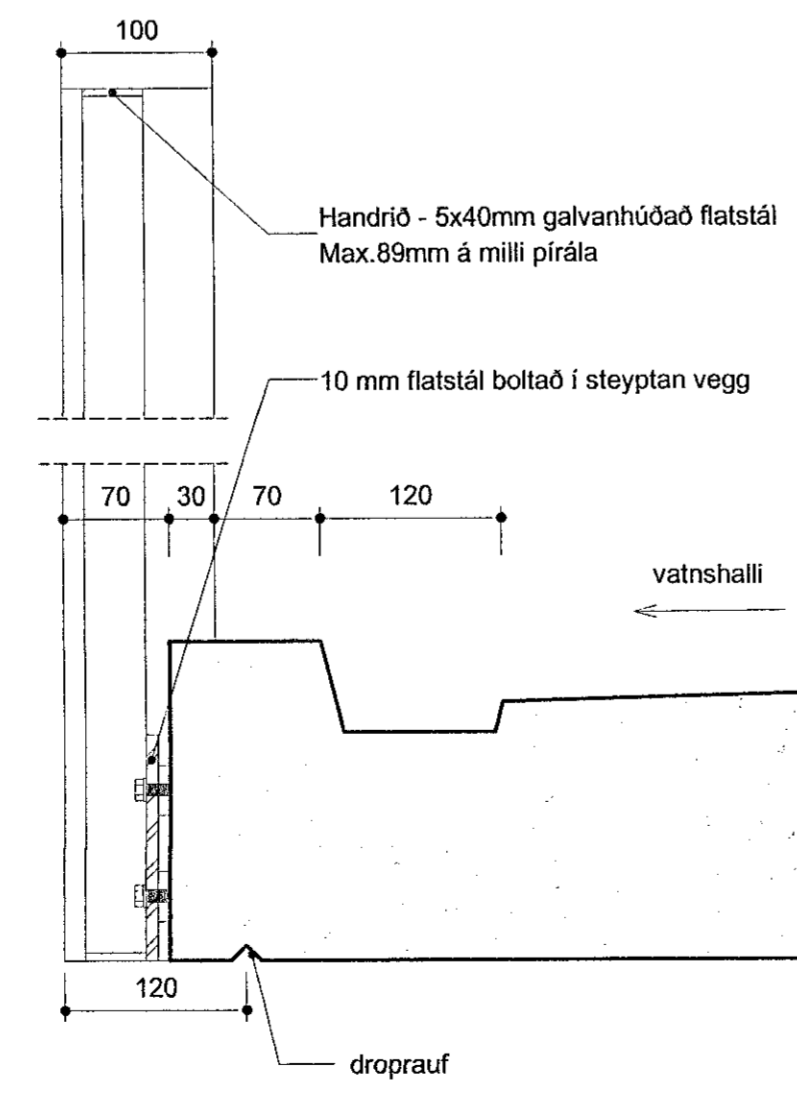

D-22- Lóðrétt
2.05-20

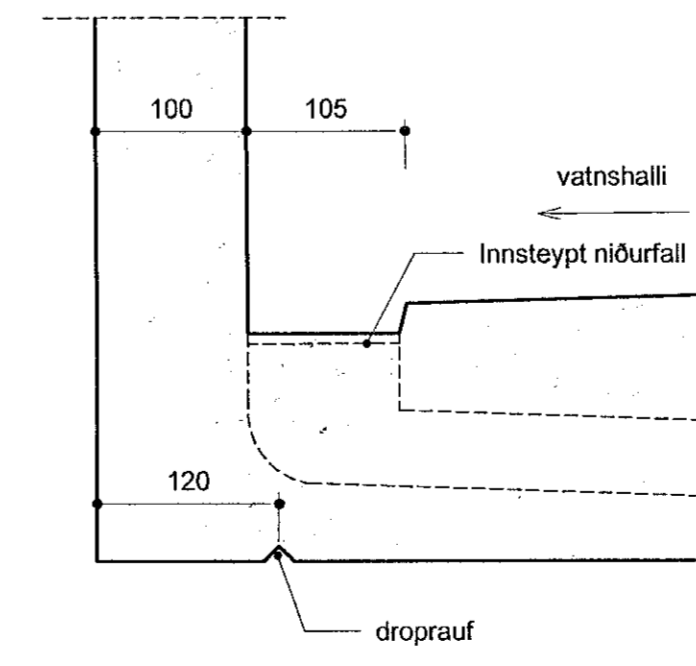

D-24- Lóðrétt
2.05-21

VERKTEIKNING GERÐ Á GRUNNI
ADALUPPDÁTTA SEM VÖRU SAMÞYKKTIR
ÞANN: 22 JUL 2021

BREYTINGAR



VERKHEITI
Nónhamar 1-3, 221 Hafnarfj.
Fjölbýlishús, mhl.01
Verkeiðningar

VERK
Deili utanhúss 4

MÁL: 1 : 5 / A1
DAGS: 01.10.2021
VERKFRAGI: AA
VERKFRAGI: H/HIL

VERKNUMER: 753-16
HVERNINGARNUMER: 04
ÚTÍG: 2.06-04

SAKPR. Ágúst Agósson
ARKITEKTUR SAMARK KL.06161-5429

Öll réttindi og áfrýðing er haldin hjá Tark. Öll réttindi og áfrýðing er haldin hjá Tark. Öll réttindi og áfrýðing er haldin hjá Tark.