

**D-13- Lárétt**  
2.01-13

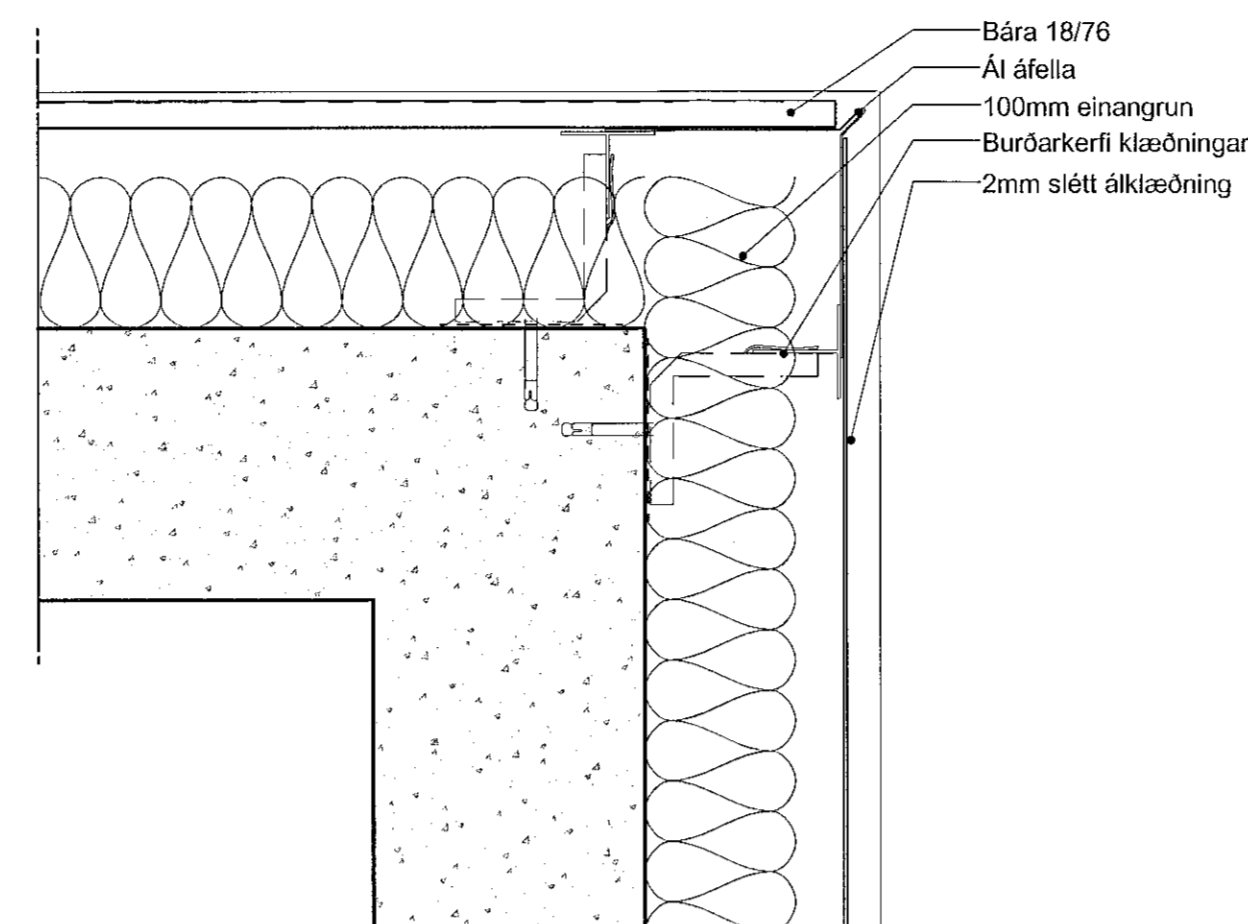

**D-14- Lárétt**  
2.01-12

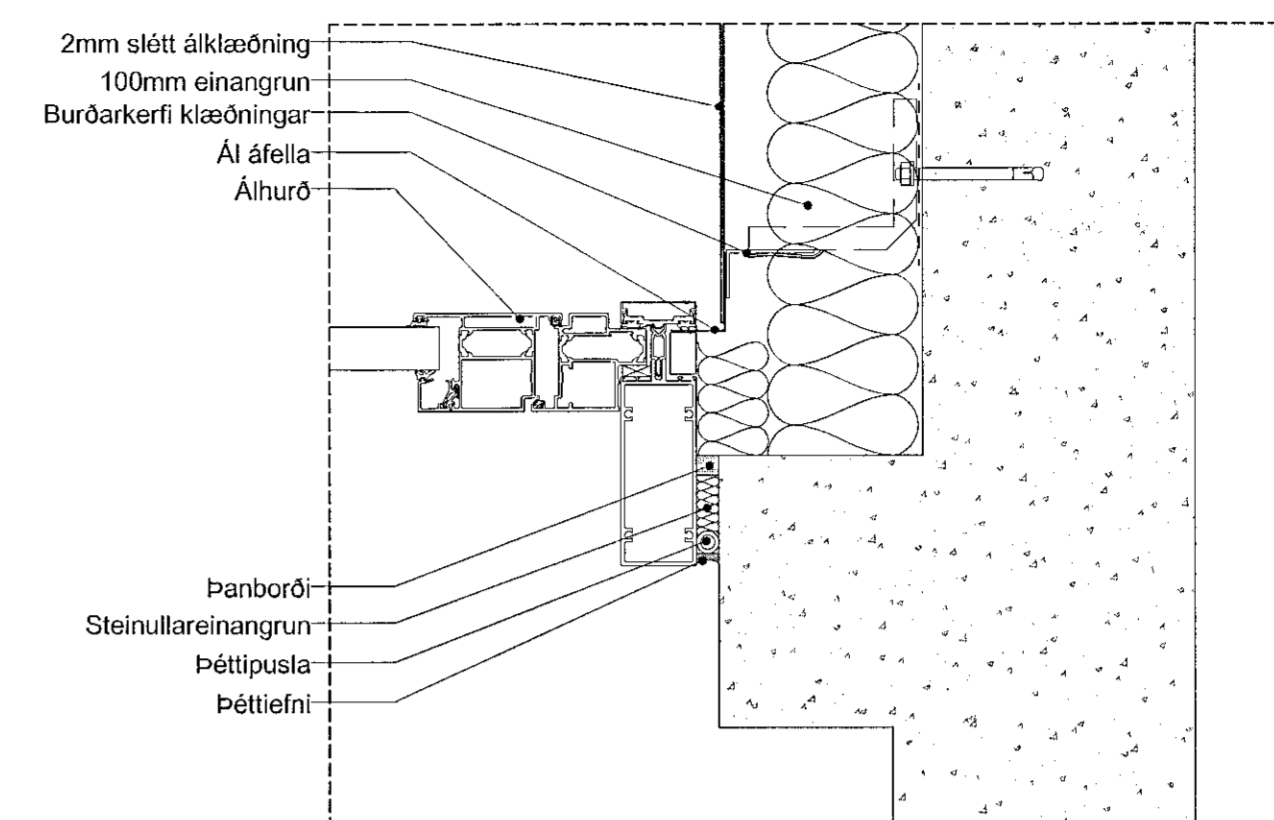

**D-15- Lárétt**  
2.01-12

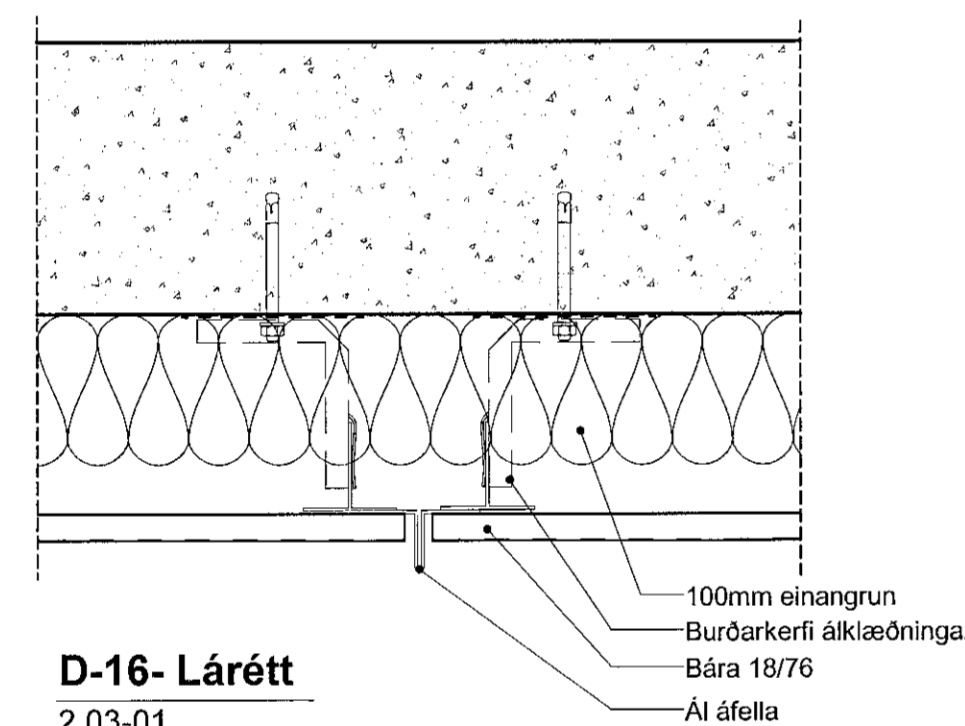

**D-16- Lárétt**  
2.03-01

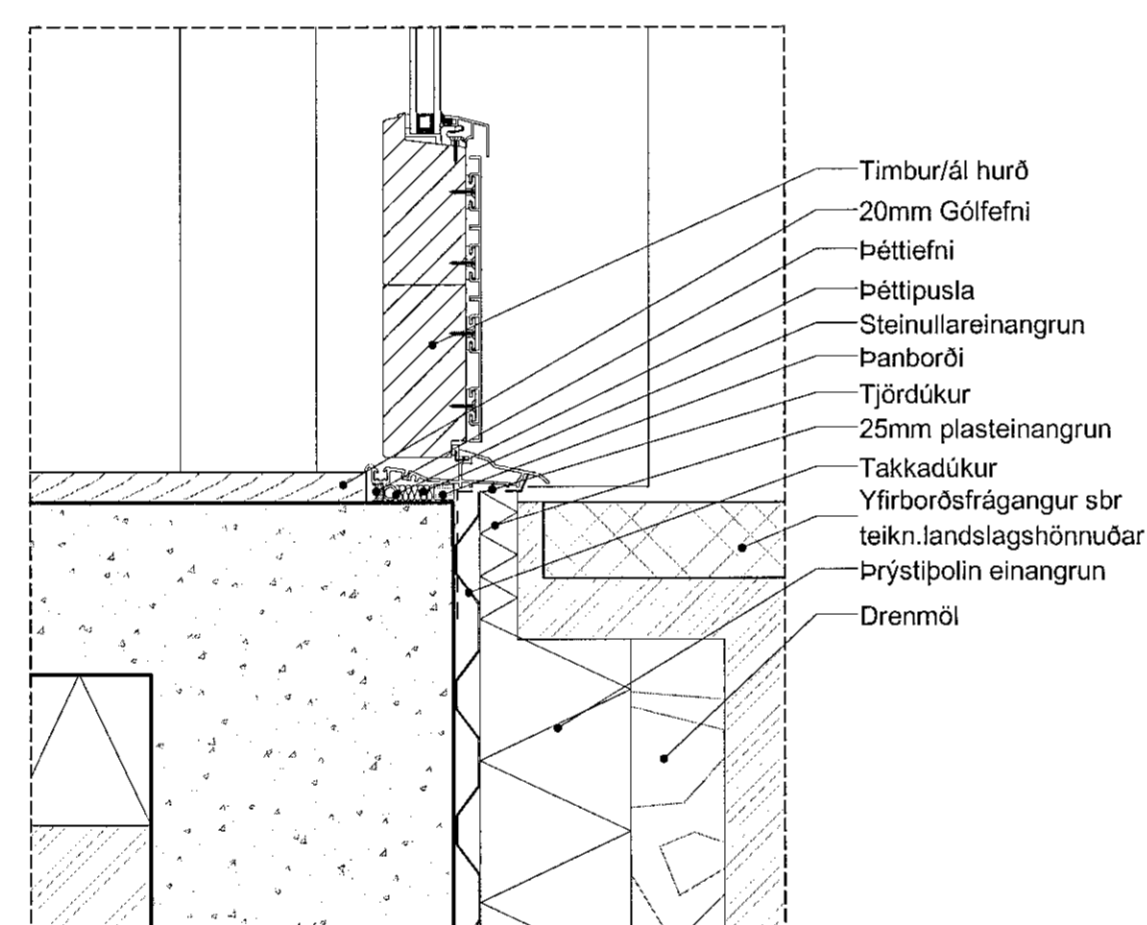

**D-17- Lóðrétt**  
2.03-03

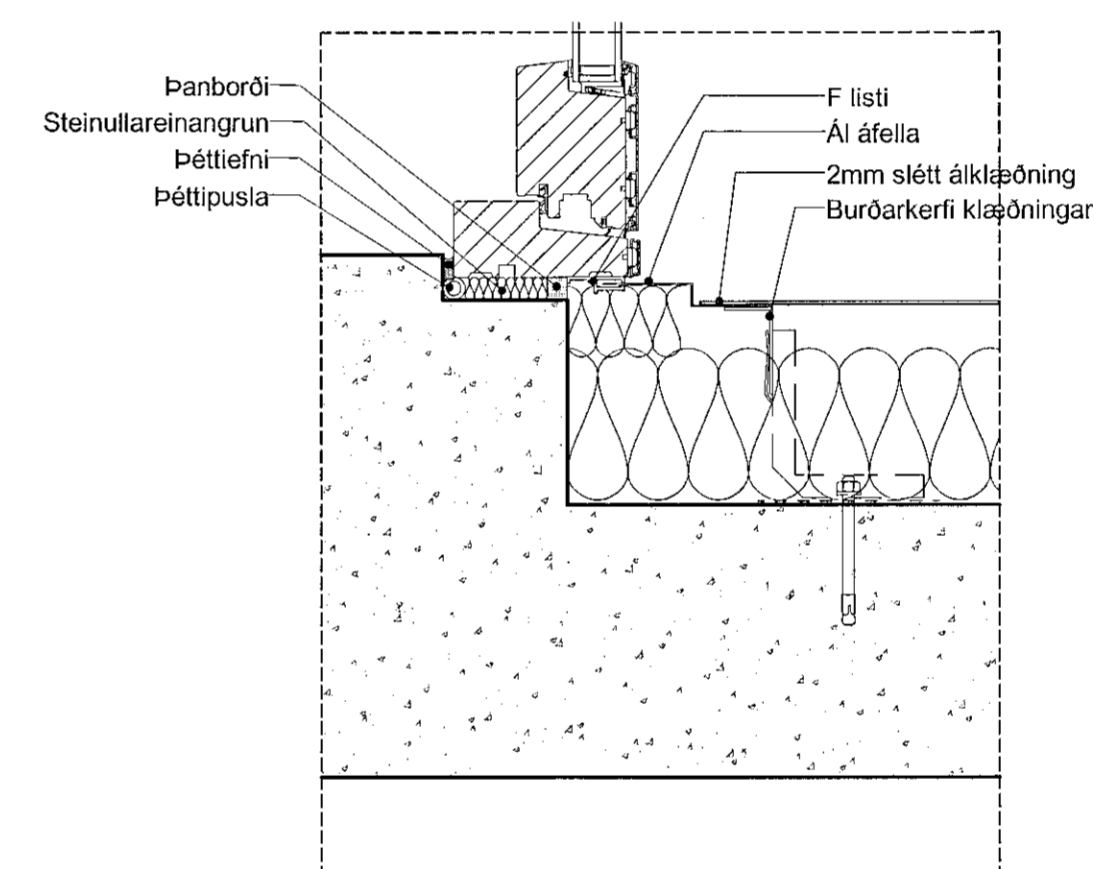

**D-23- Lárétt**  
2.01-12

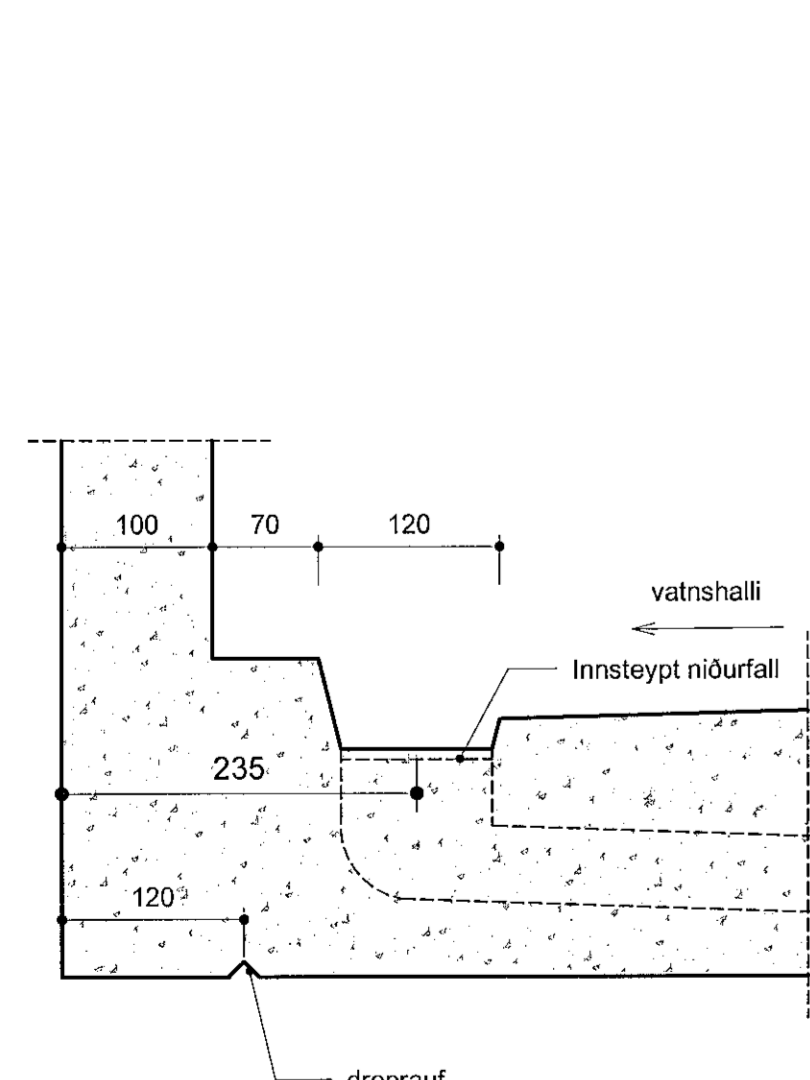

**D-21- Lóðrétt**  
2.05-20

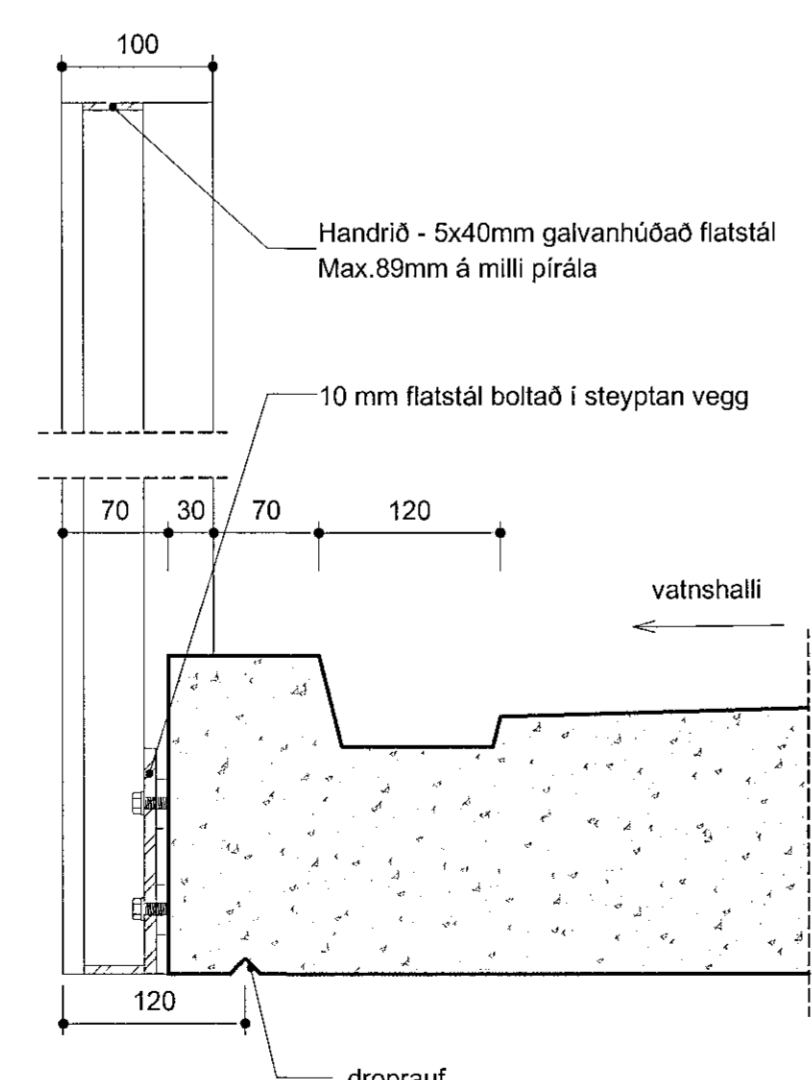

**D-22- Lóðrétt**  
2.05-20

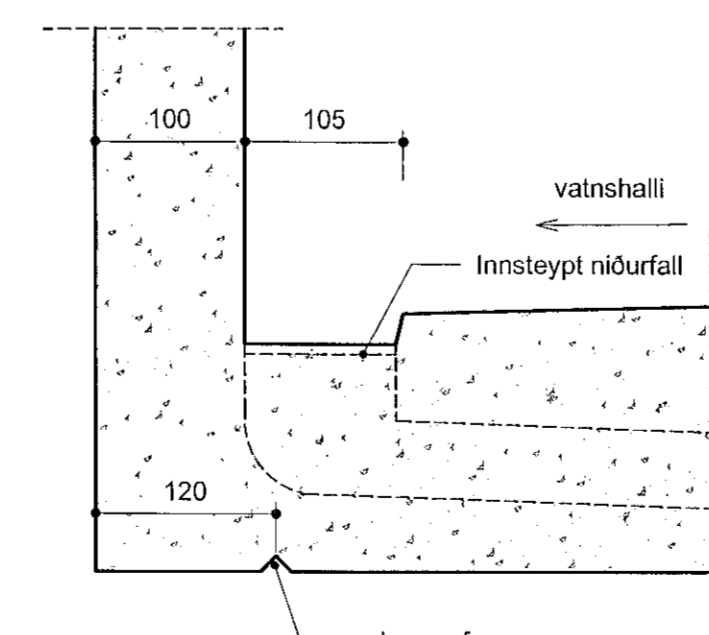

**D-24- Lóðrétt**  
2.05-21

VERKTEIKNING GERD Á GRUNNI  
ABALUPPDRATTA SEM VORU  
SAMÞYKKTIR ÞANN: 22 JUL 2021

BREYTINGAR



VERKHEITI  
**Hringhamar 2, 221 Hafnarfj.**  
Fjölbýlishús  
Verkeiðningar

VERK  
**Deili utanhúss 4**

MÁL: 1 : 5  
HANNADI: AA  
VEIÐFARIR: ISC  
VERKINGMÉR: 753-16  
DAGS: 01.10.2021  
TEIKNADI: HI  
TEIKNINGANÖMÉR: 04  
OTG: 2.06-04

SAMR. Ásgeir Eggertsson  
SAMR. MAA SAMARK K1.060161-5429

Öll athol og áhrif tekið tillit til, er það samþykkið löðuð, skv. ávarðum höfundar.