

D-01- Lóðrétt
2.02-01

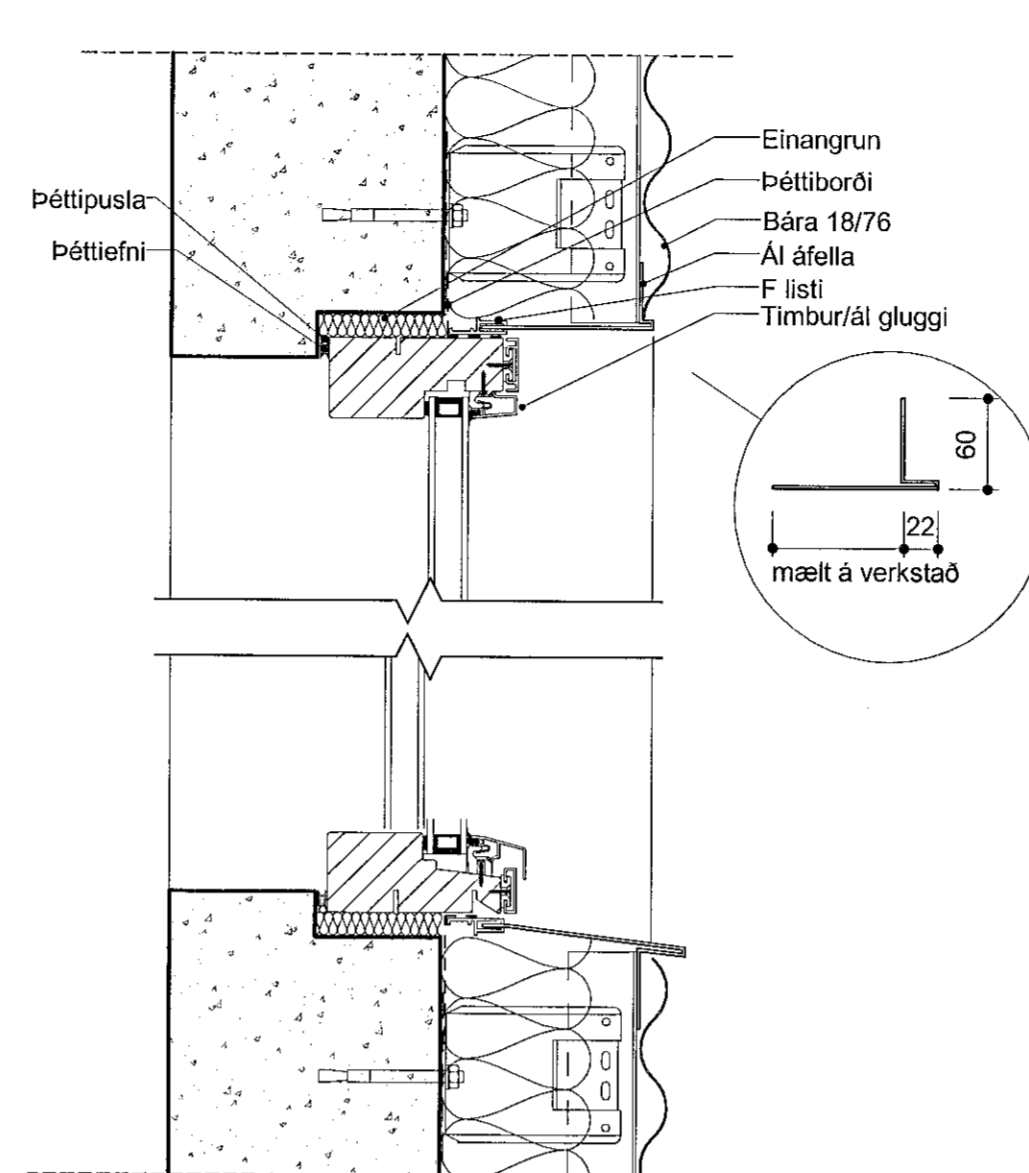

D-18- Lóðrétt
2.02-01

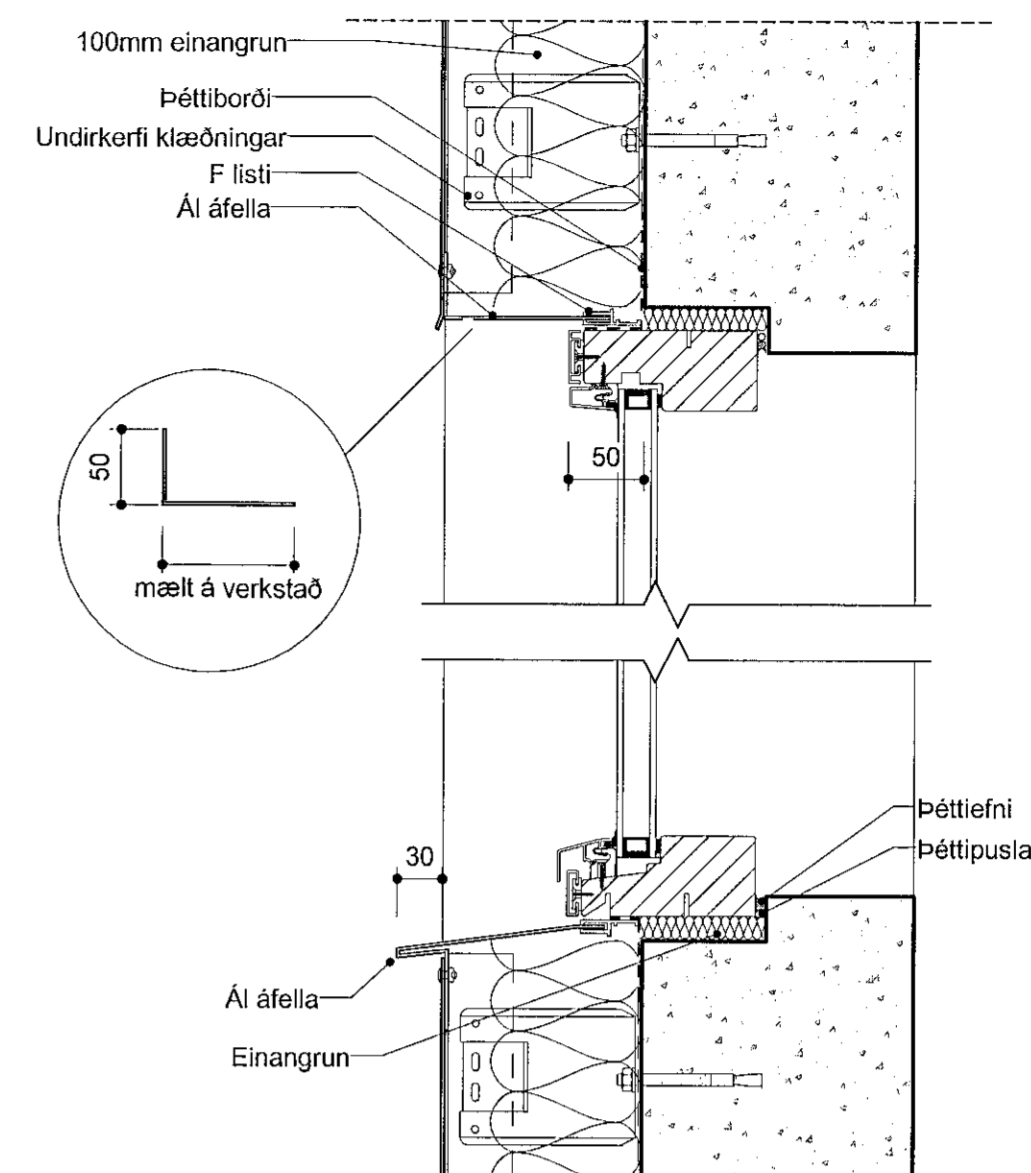

D-04- Lóðrétt
2.02-01

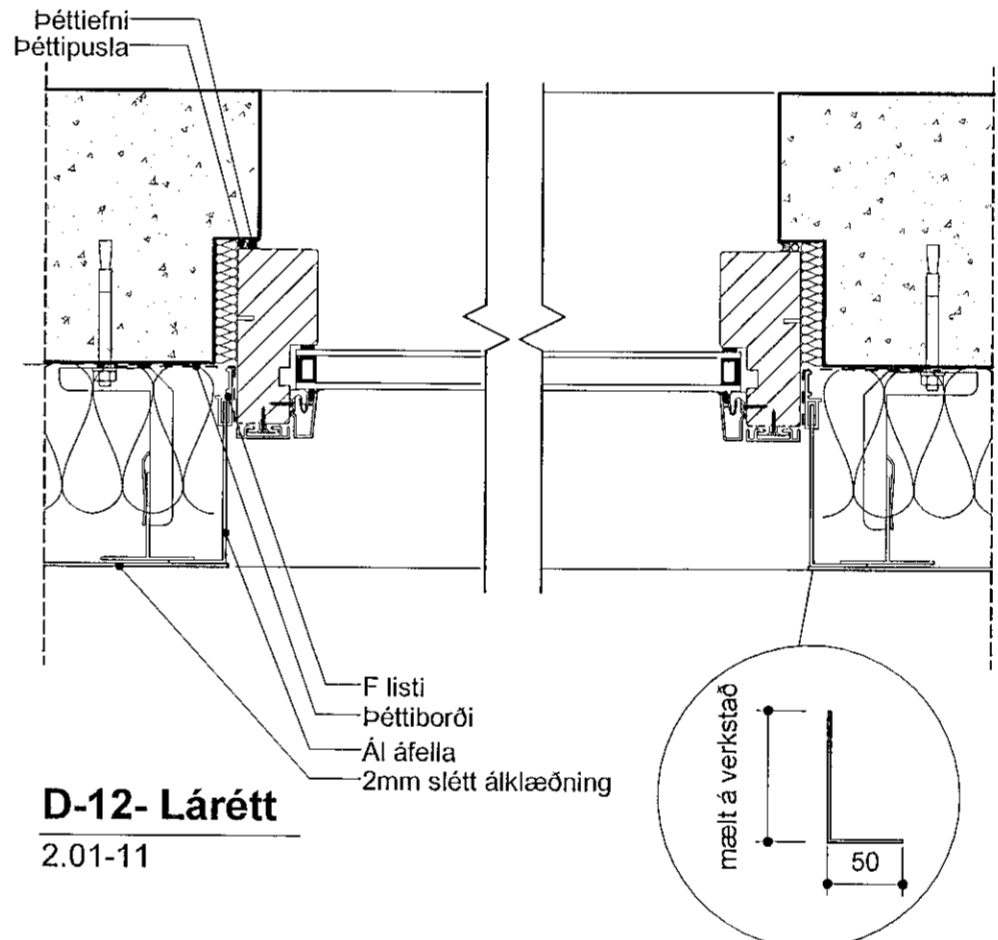

D-12- Lárétt
2.01-11

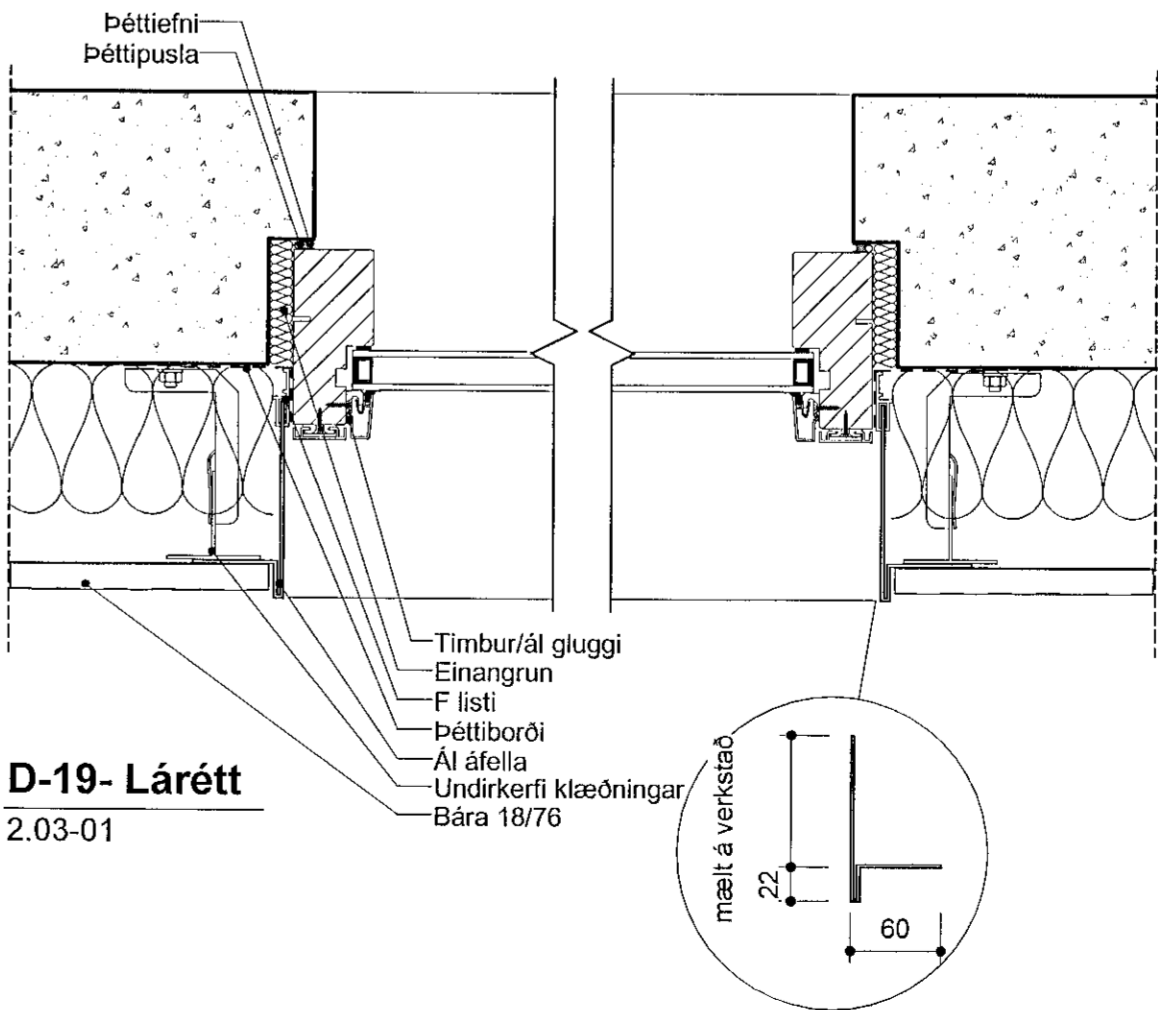

D-19- Lárétt
2.03-01

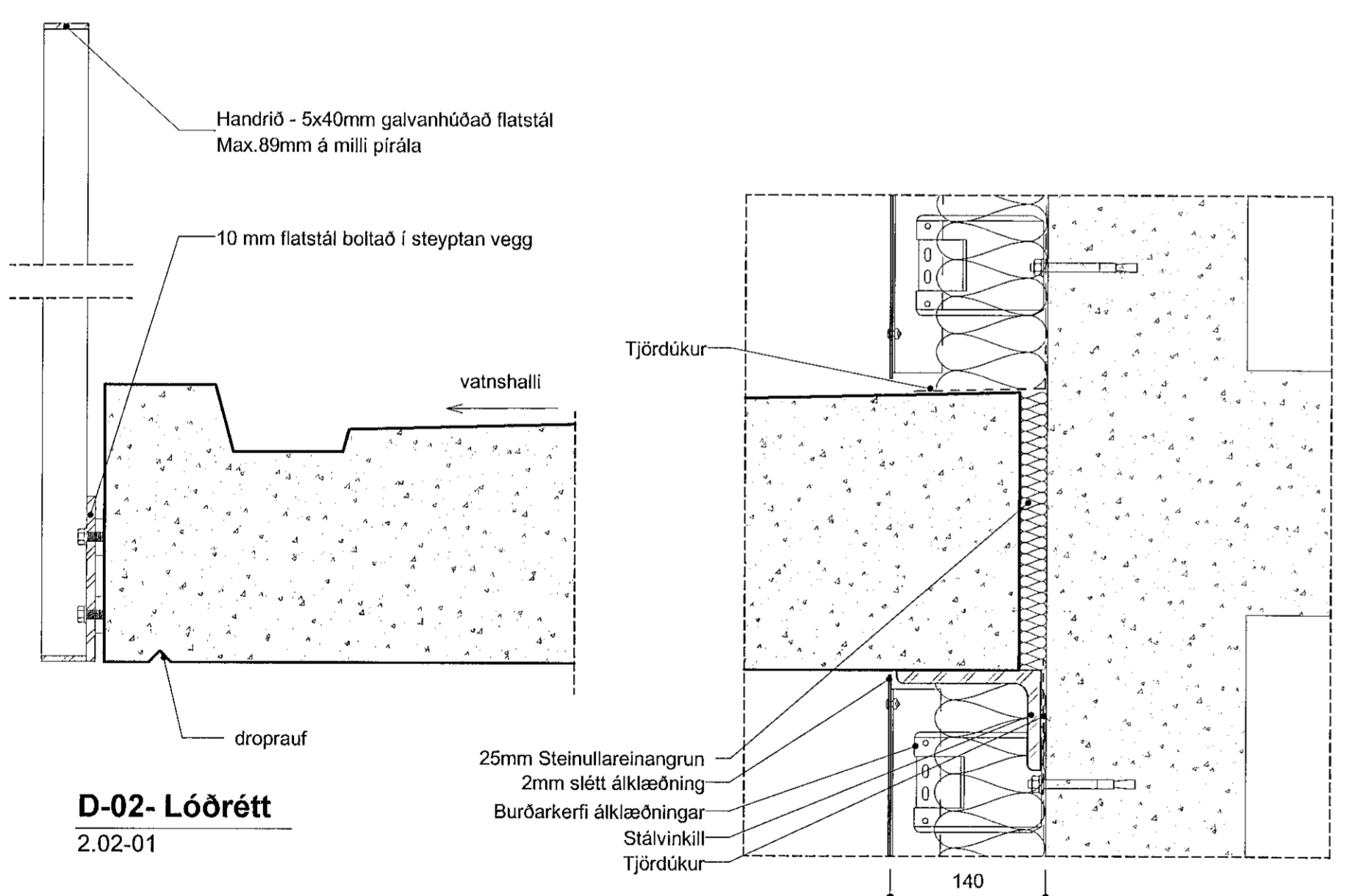

D-02- Lóðrétt
2.02-01

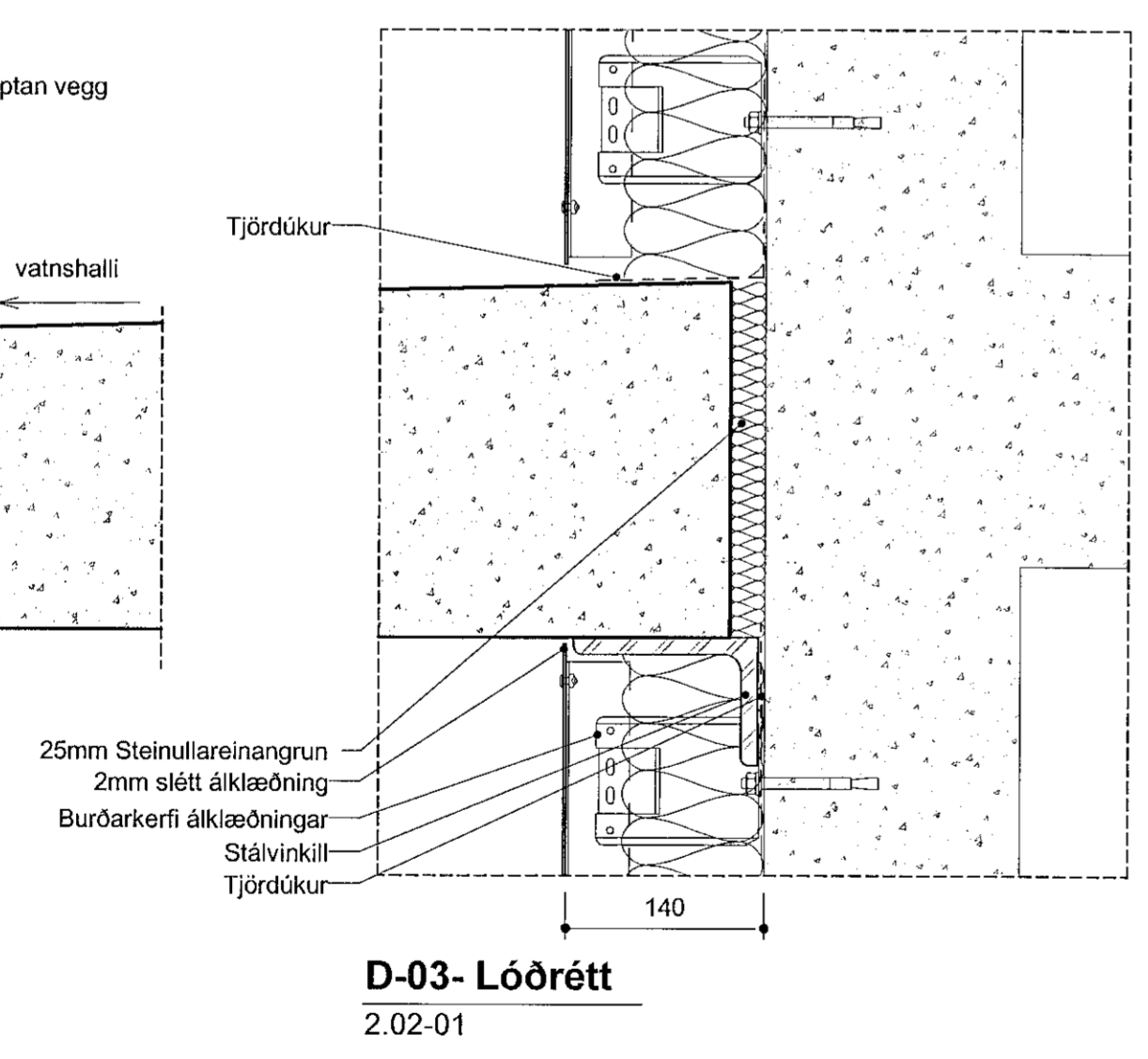

D-03- Lóðrétt
2.02-01

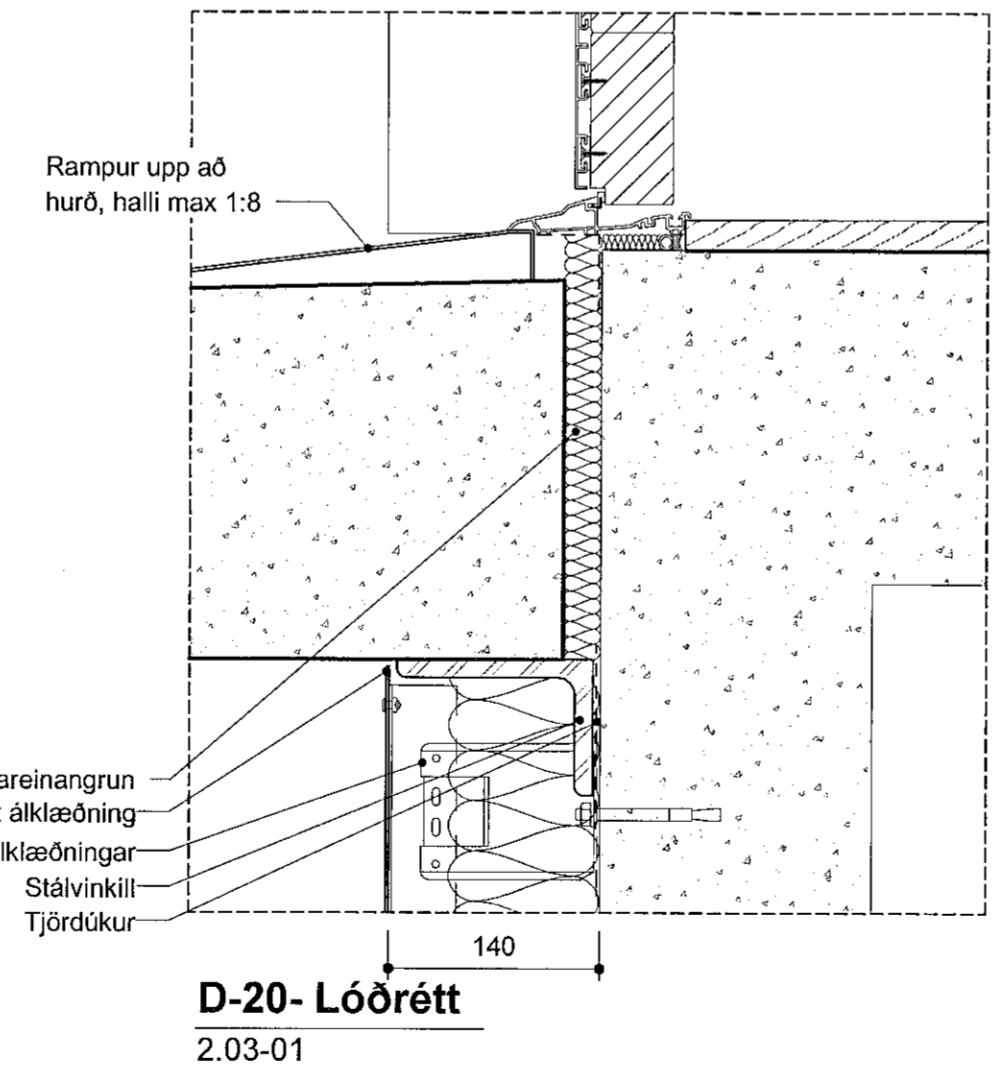

D-20- Lóðrétt
2.03-01

VERKTEIKNING GERD Á GRUNNI
AÐALUPPDRATTA SEM VORU SAMÞYKKTIR ÞANN
22 JUL 2021

A 20.10.2021 HB Endurútfétið óbreytt
BREYTINGAR



VERKHEITI
**Nónhamar 1-3, 221 Hafnarfj.
Fjölbylishús, mh.02**
Verkeiðningar

VERK
Deili utanhúss 1

MÁL: 1:5
MÁNNAG: AA
YFIRFARIR: ISC
VERKNAÐMÉR: 753-16

DAGS.: 30.06.2021
TEIKNAD: HI
FL. TEIKNINGANOMER: 04
GTG: 2.06-01 A

SAMÞ. Ásgeir Ásgeirsson Arkitekt MAA SAMARK Kl. 060161-5429

Öll efnis og áfrit tekið, að hluta eða heild, er háð samþykki höfundis, skv. ákvæðum höfundalaga.