

Samþykkt þann
 25. nóv. 2022
 Til: Byggingerfulltrúans í Hafnarfirði
 Róbert A. Róbertsson

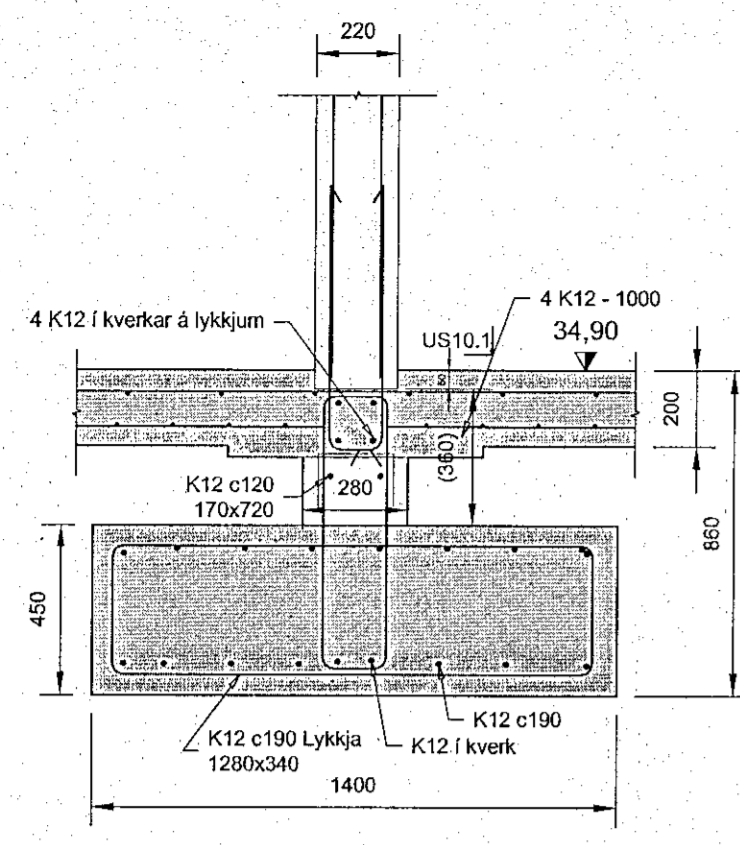

US10 Snið
 1:10

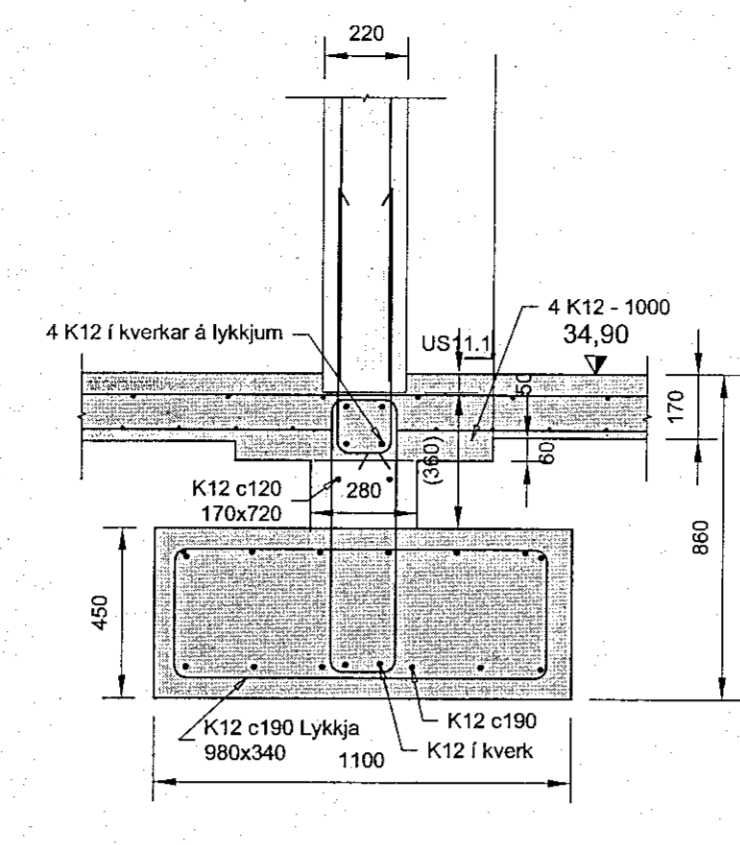

US11 Snið
 1:10

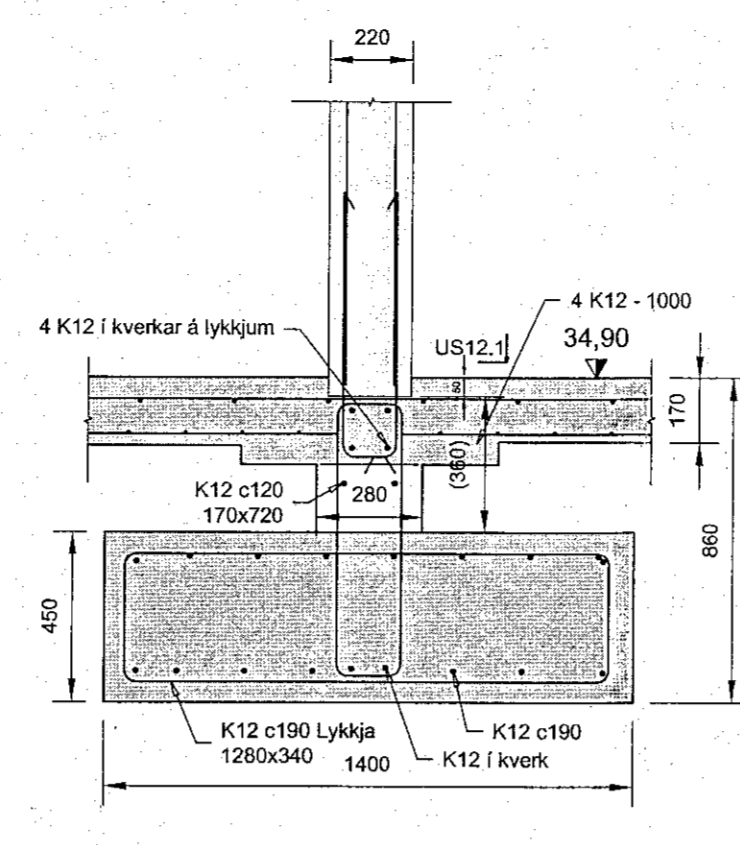

US12 Snið
 1:10

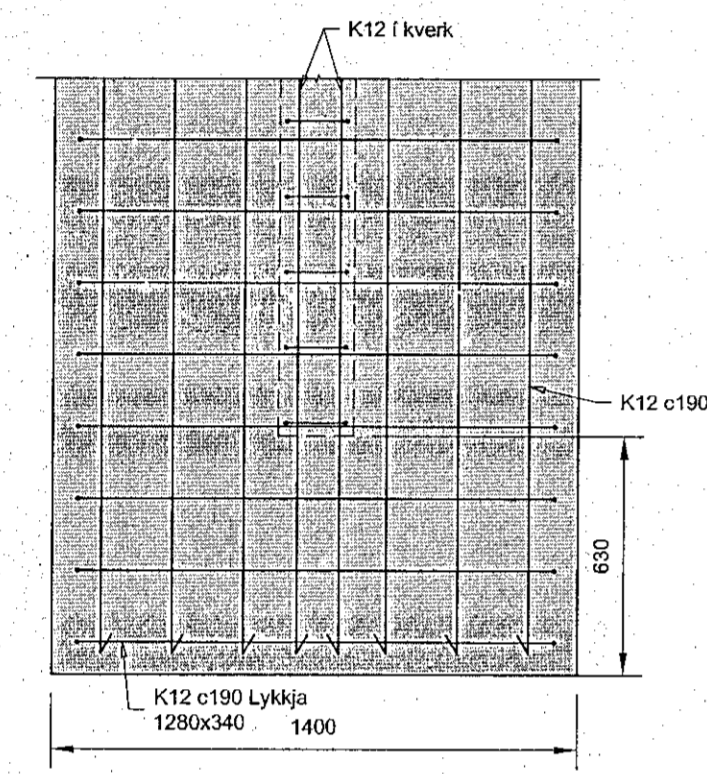

US10.1 Undirstaða
 1:20

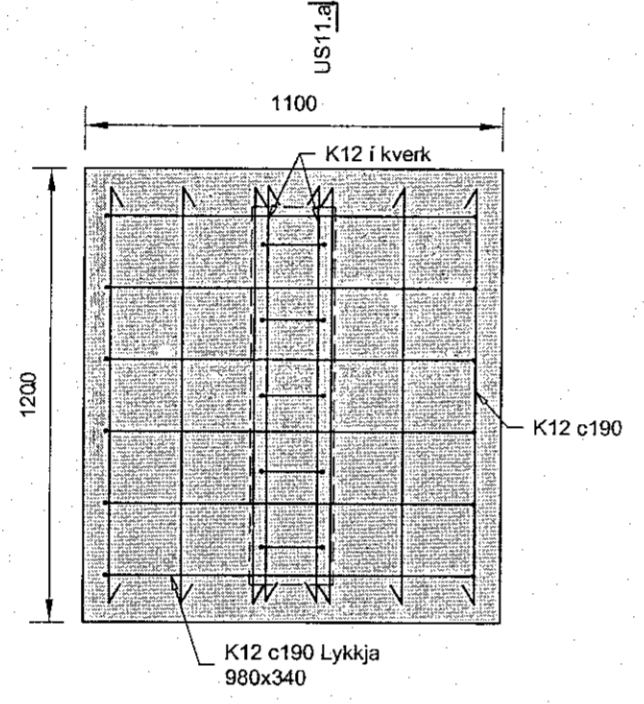

US11.1 Undirstaða
 1:20

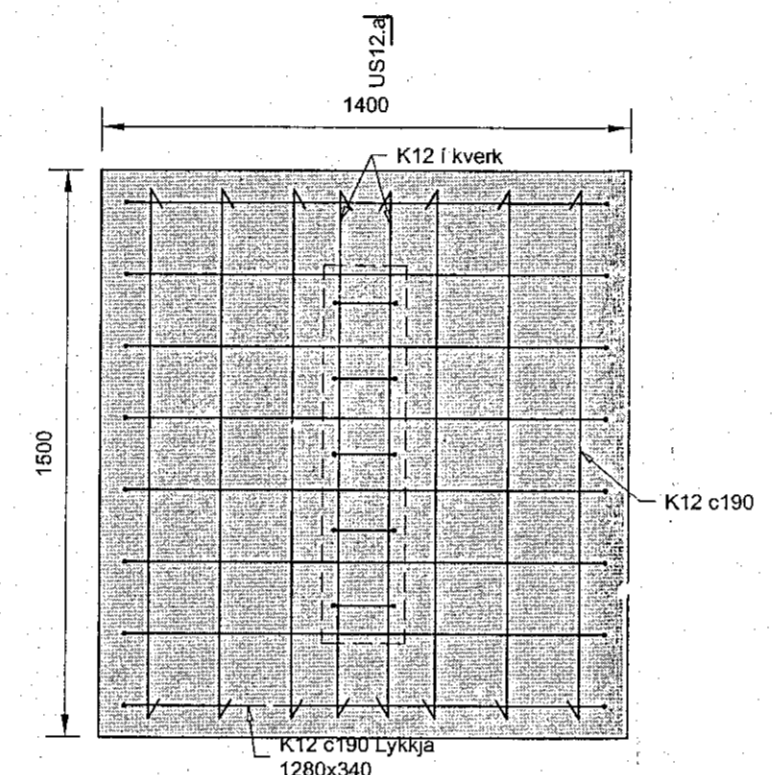

US12.1 Snið
 1:20

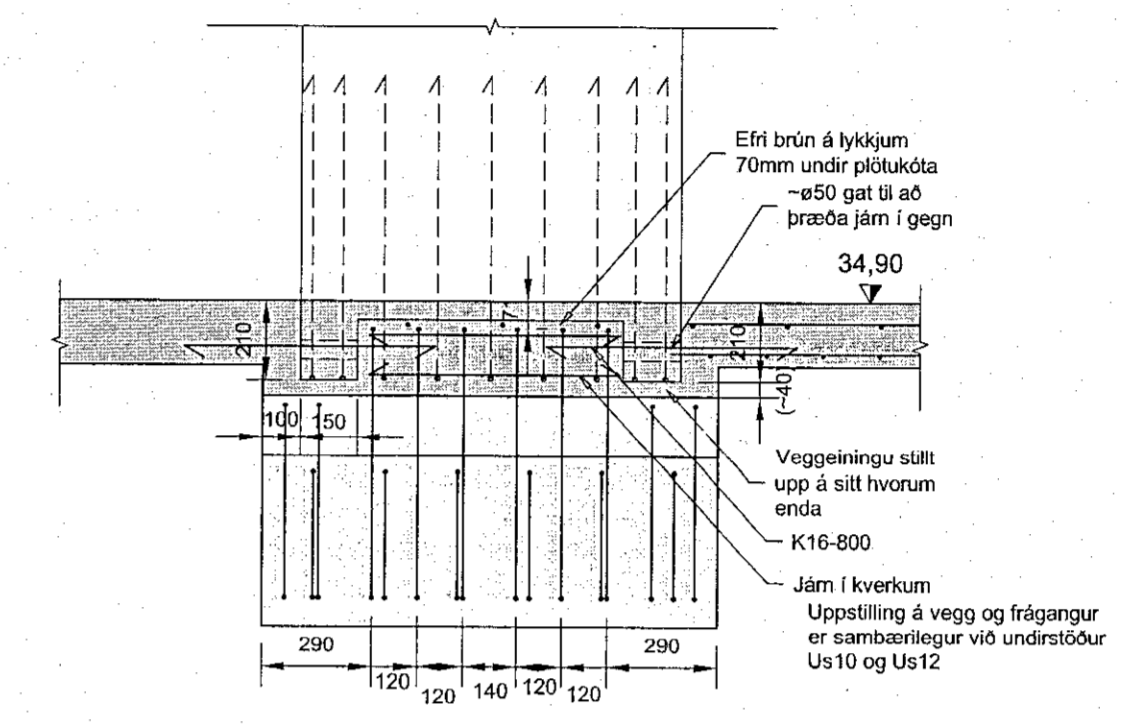

US11a Snið, uppstilling á veggveingju
 1:20

Öll mál eru í mm, hæðarkótar í m

Útgáfa: B01	Skýring: Byggingarteikning	Dagur: 09.11.2022	Heimil: BH/BMH
Dags undirskrift: <i>Kristinn Ragnarson</i> Nafn og titill hönnuðs: Kristinn Ragnarson Kl.120944-2669 Netfang: krak@krak.is Undirskrift hönnuðs: <i>Kristinn Ragnarson</i>			
Notað hönnuð: Bergþór Helgason Kl. 270474-4899 Netfang: beggi@bmvalla.is Bjarni Már Hauksson Kl. 301279-5909 Netfang: bjarni@bmvalla.is		Kl. 450510-0680 - Bítastíóla 7 - 110 Reykjavík - Sími: 412-5000 - Fax: 412-5001	
Undirskrift og titill hönnuðs: Ef. BM Vallá Bergþór Helgason 270474-4899 <i>BH</i>			
Bláuritari: A1	MKV: 1:20	Tekni: BHVGN	Dagur: Yfirfarið:
Vork: Straumhella 6, Hafnarfjörður Iðnaðarhúsið Burðarbol - Undirstöður Undirstöðuplattar og snið			Tölkning nr: B104 Vnr: V22-032