

1601397 15. 09. 2016

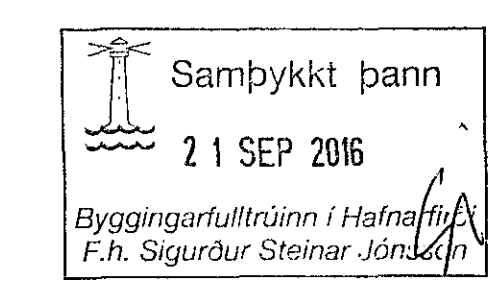

SKÝRINGAR

Kótar eru í m.y.s
Málsetningar eru í mm

- Merkir hæðarkóti í sniði
- Merkir hæðarkóti í plani
- Merkir þykkt plötu

Sjá einnig skýringarblað

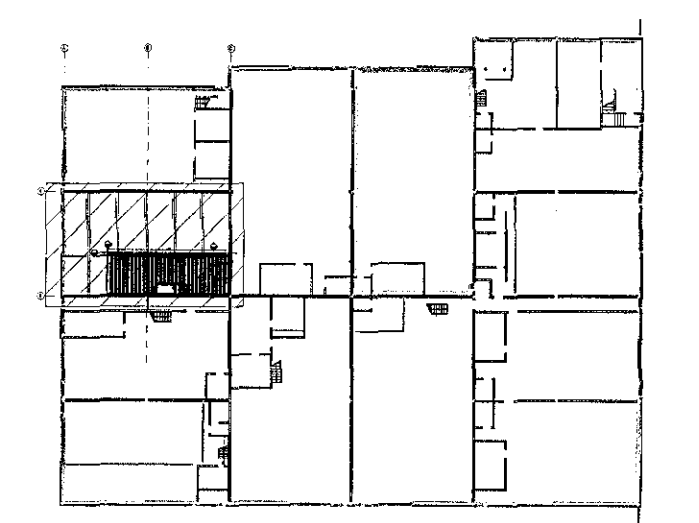
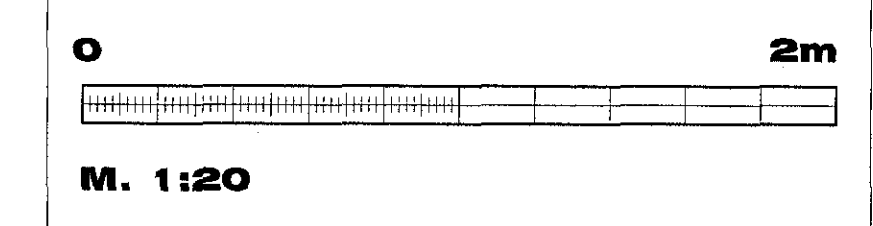
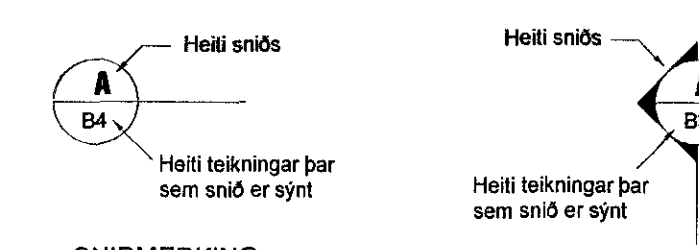

LYKILMYND

- G
- F
- E
- D
- C
- B
- A

BREYTINGAR

Samþykkt Samþykki aðalhönnuðar

VEB Verkfæðistofa
Dalvegji 16 201 Kópavogi
Sími 564 3322, GSM 998 1198
Netfang ve@veb.is
Ráðgefandi verkfræðipjónusta

VERKHEITI
RAUÐHELLA 5
220 HAFNARFJÖRÐUR

Teikning nr
B101

HEITI TEIKNINGAR
MILLIGÓLF - STYRKING
SNID

Dagsetning SEPT 2016	Hannað ARG	Yfirlitað ERLENDUR BJRIBSSON 20160920	Kvarði 1:20	Verknumér 3.16.03
-------------------------	---------------	---	----------------	----------------------

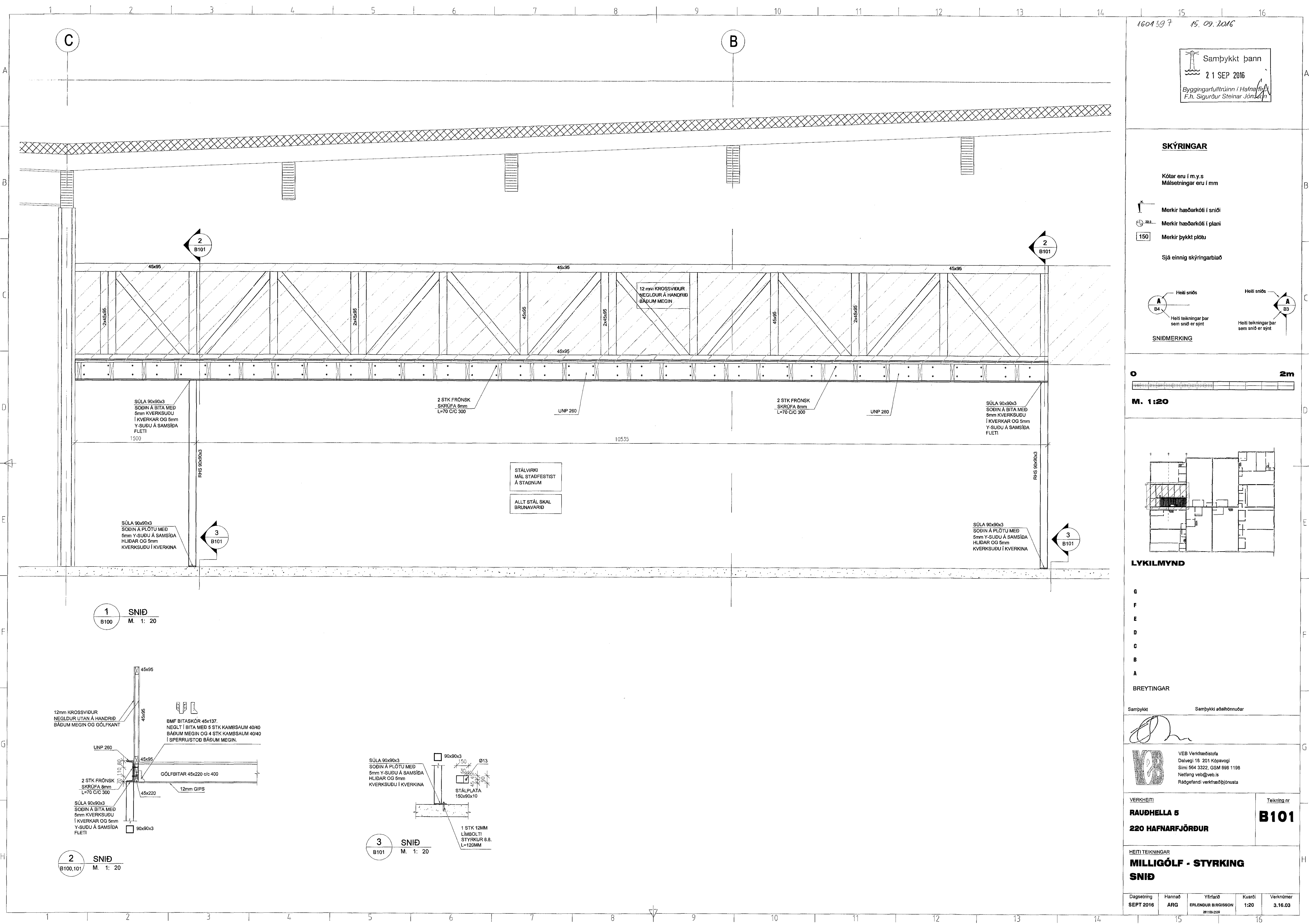

1 SNID
B100 M. 1: 20

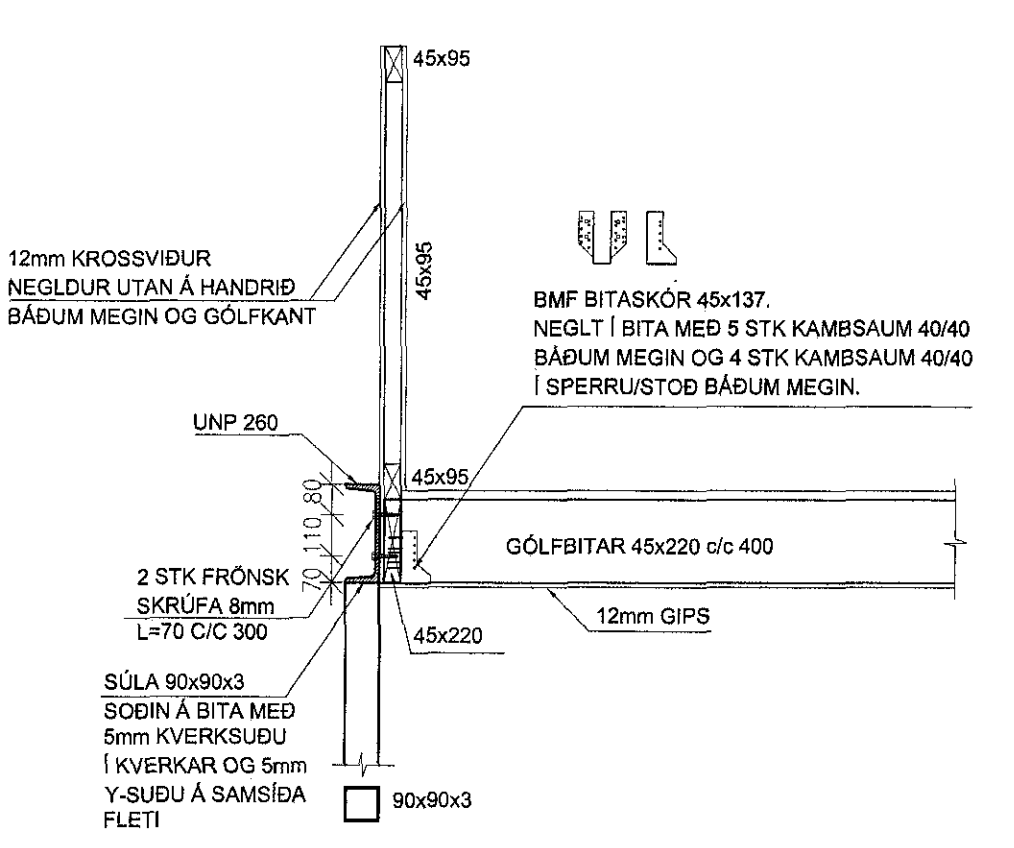

2 SNID
B100,101 M. 1: 20

3 SNID
B101 M. 1: 20

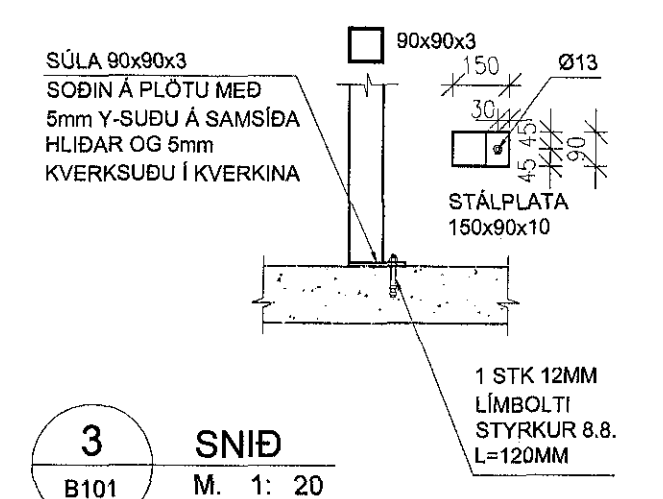

STÁLVIKRI
MÁL STADFESTIST
Á STADNUM

ALLT STÁL SKAL
BRUNAVARÐ