

1609081

10.04.2017

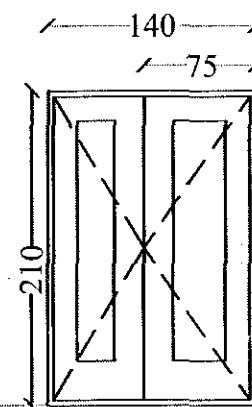

2 stk hurð, opnast út
hurðir á vestur og austur gaffi
mkv. 1:50

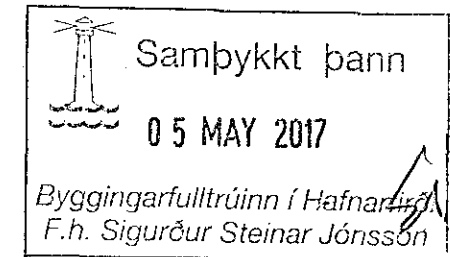
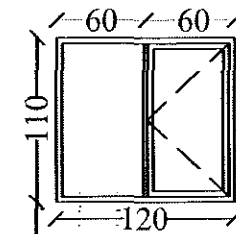

1 stk gluggi á vestur gaffi
mkv. 1:50

gólfkóti 27,60m

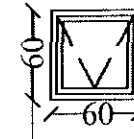

8 stk opnanlegt fög, göflum,
innskoti suðurhlið, norðurhlið
mkv. 1:50

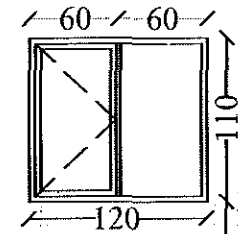

1 stk gluggi á austur gaffi
mkv. 1:50

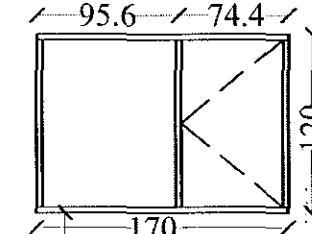

5 stk gluggi á suður hlið
mkv. 1:50

gólfkóti 27,60m

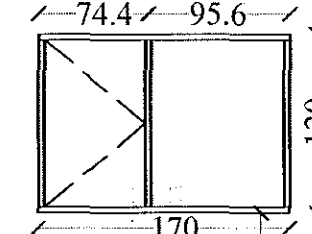

7 stk gluggi á suður hlið
mkv. 1:50

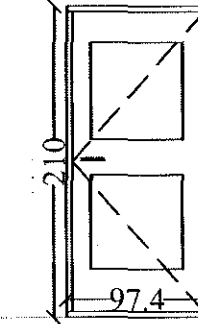

1 stk hurð, opnast út
hægri hurð, hurð á suður hlið
mkv. 1:50

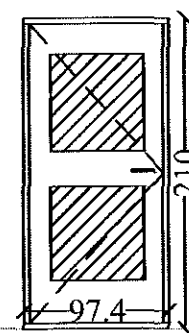

2 stk hurð, opnast út
vinstri hurðir, hurðir á suður hlið
mkv. 1:50

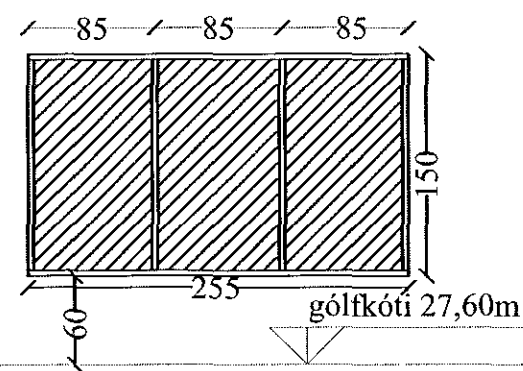

3 stk gluggi á norður hlið
mkv. 1:50

gólfkóti 27,60m

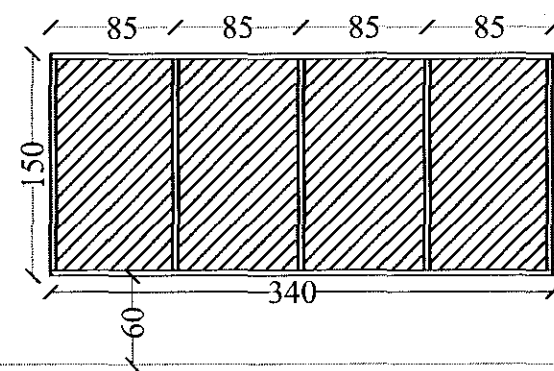

3 stk gluggi á norður hlið
mkv. 1:50

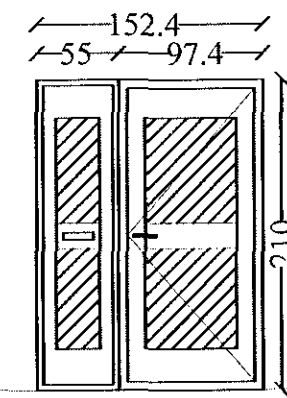

2 stk hurð, opnast inn í íbúð
vinstri hurðir, hurðir á norður hlið
mkv. 1:50

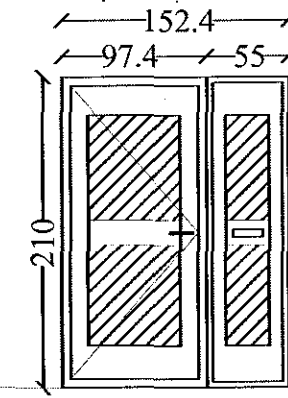

1 stk hurð, opnast inn í íbúð
hægri hurð, hurð á norður hlið
mkv. 1:50

gólfkóti 27,60m

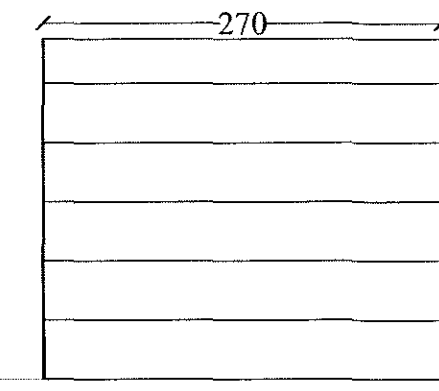

3 stk bílskúrshurðir norður hlið
mkv. 1:50

BR.	BR. DAGS	EDLI BREYTINGA.	SIGN.

STADUR: Hnoðravellir 35-37-39, Raðhús. 221 Hafnarfirði.	TEIKNING NR: HG0101
SKYRING: Glugga- og hurðarteikning	KVARÐI: 1:50
SIGURBJARTUR HALLDÓRSSON kt: 230656-3479, Vnr:43064. BYGGINGATEKNIFRÆÐINGUR. FTFL. Laxakvísl 35, 110 Reykjavík hs:567-1065, 755-2233... sigurbja@simnet.is	REIKN: Sigurbj. Hall.
SAMP: <i>[Signature]</i>	TEIKN: Sigurbj. Hall.
	DAGS: 10.03.2017
	VERK NR: Hnoðravellir 35-39