

1-1

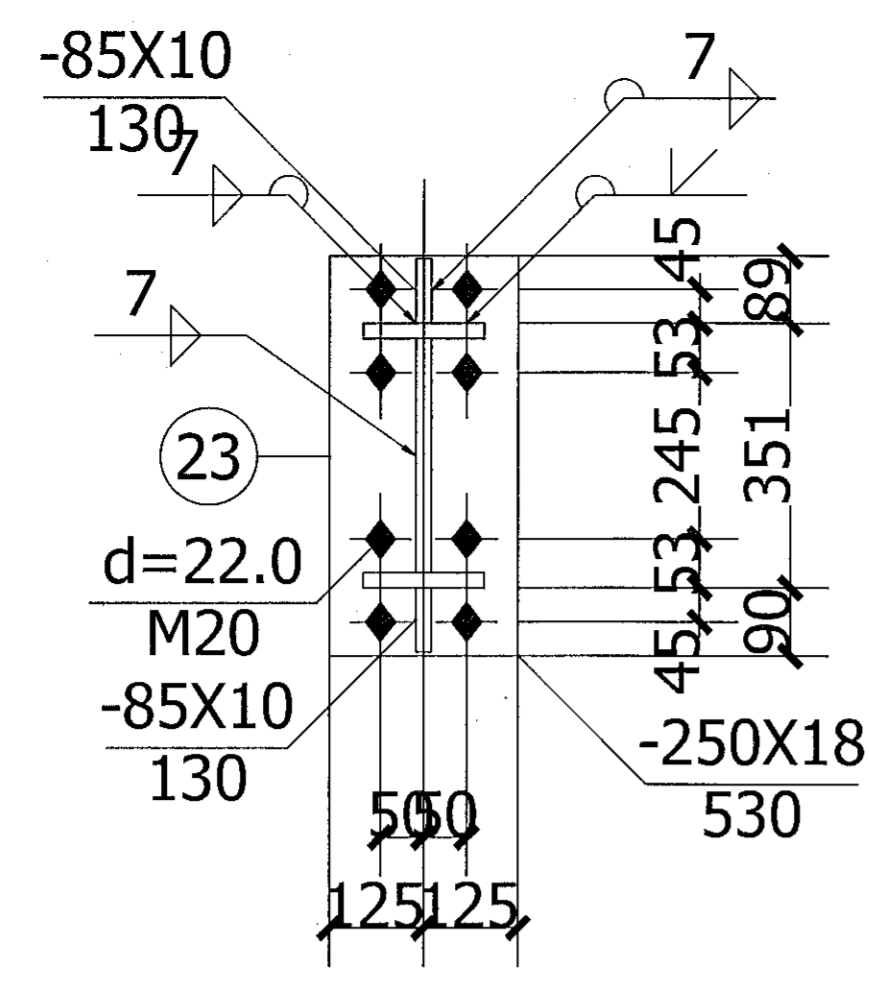

2-2

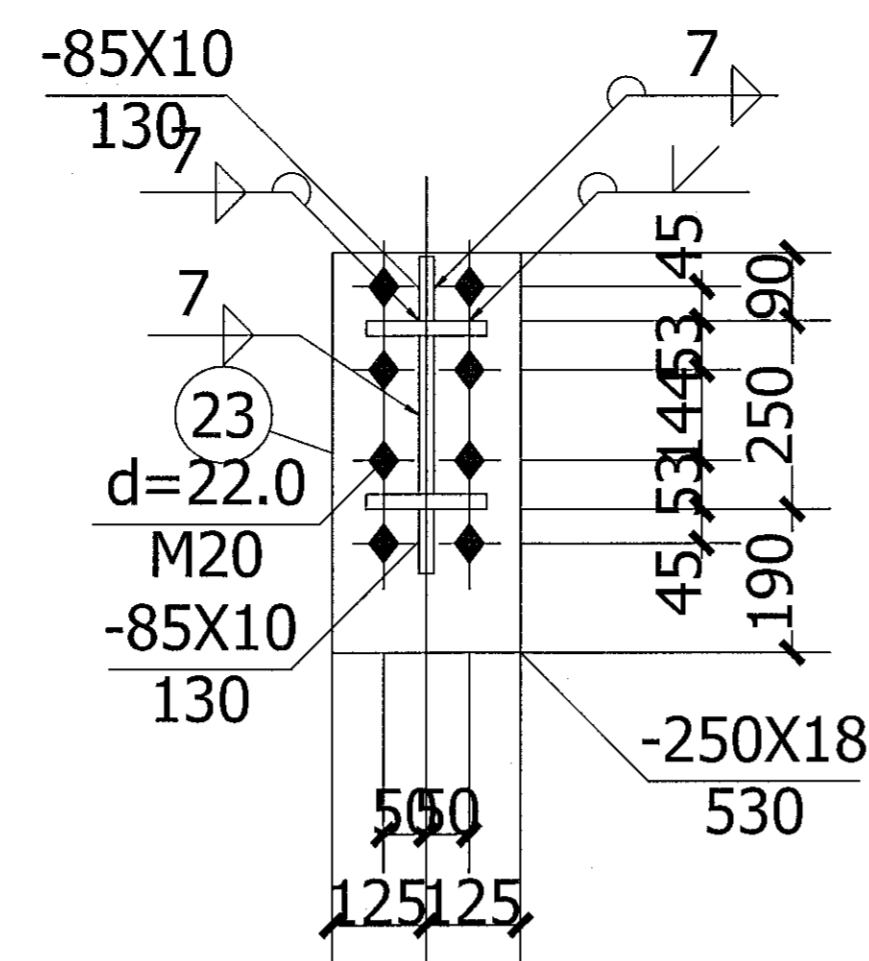

3-3

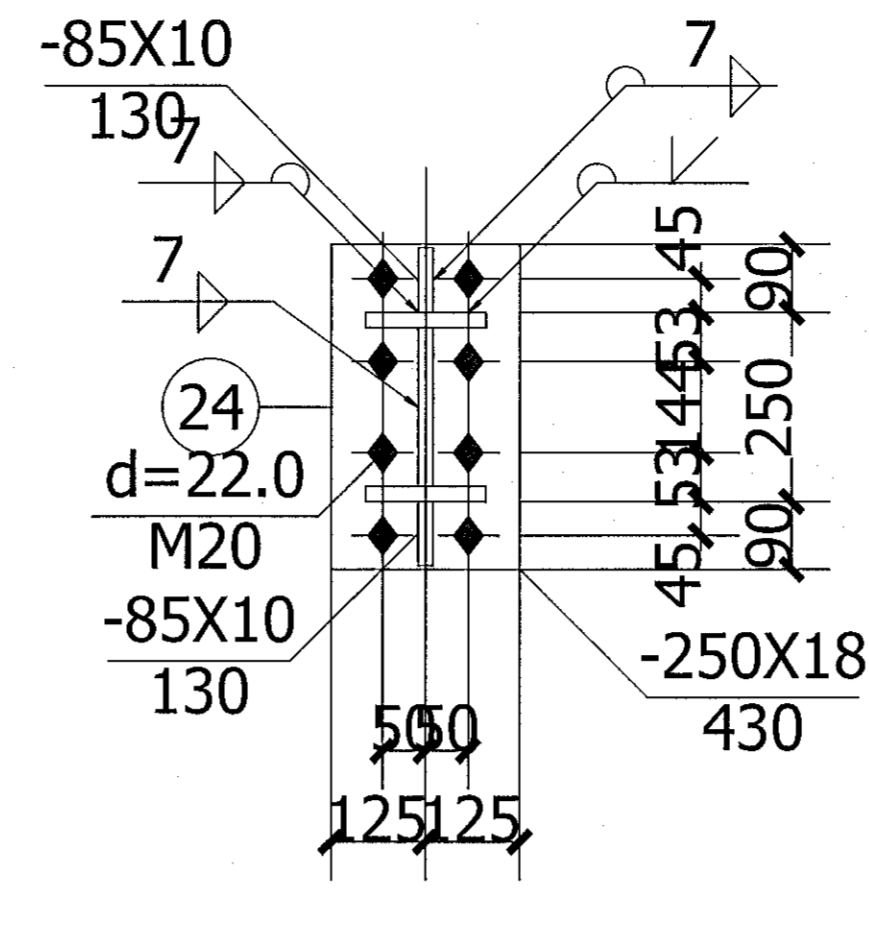

4-4

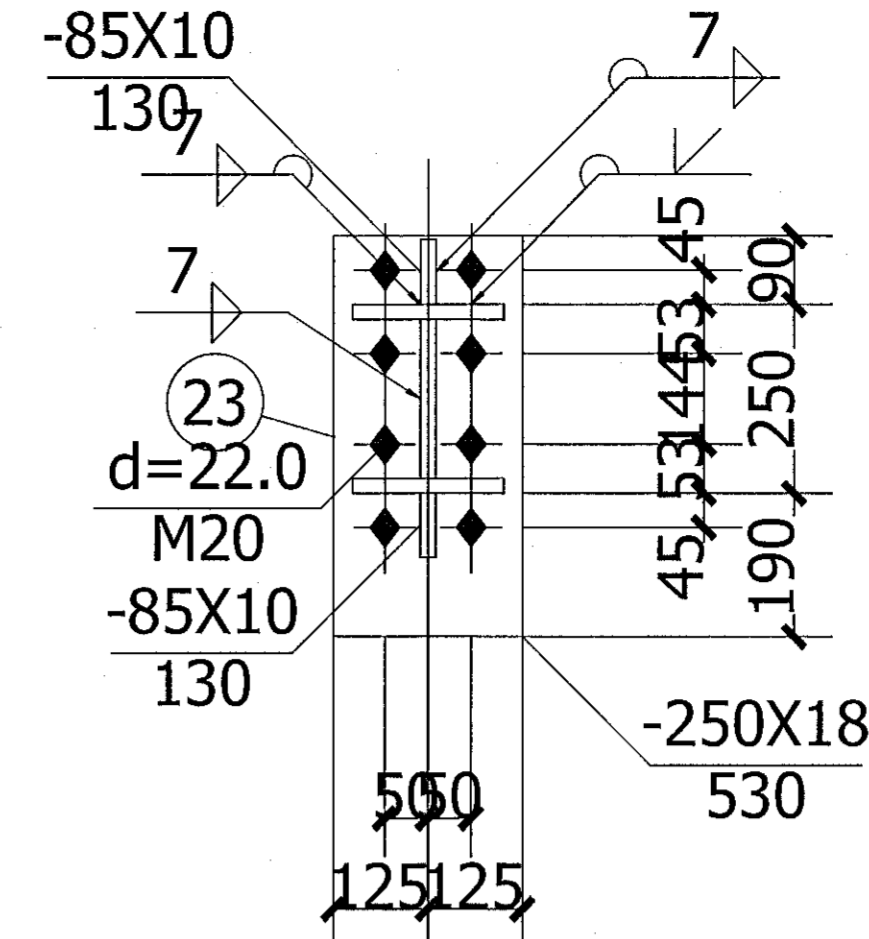

5-5

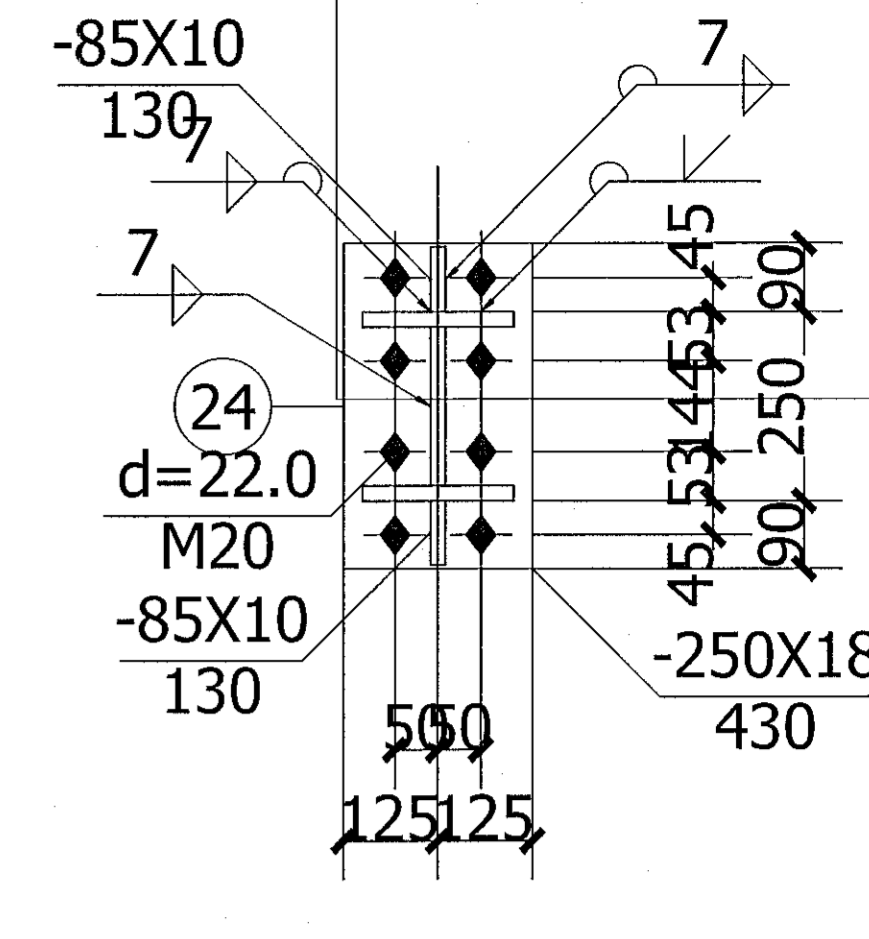

6-6

Samþykkt bann
12 JUL 2019
Byggingarfulltrúinn í Hálförðum
F.h. Sigurður Steinar Jónsson

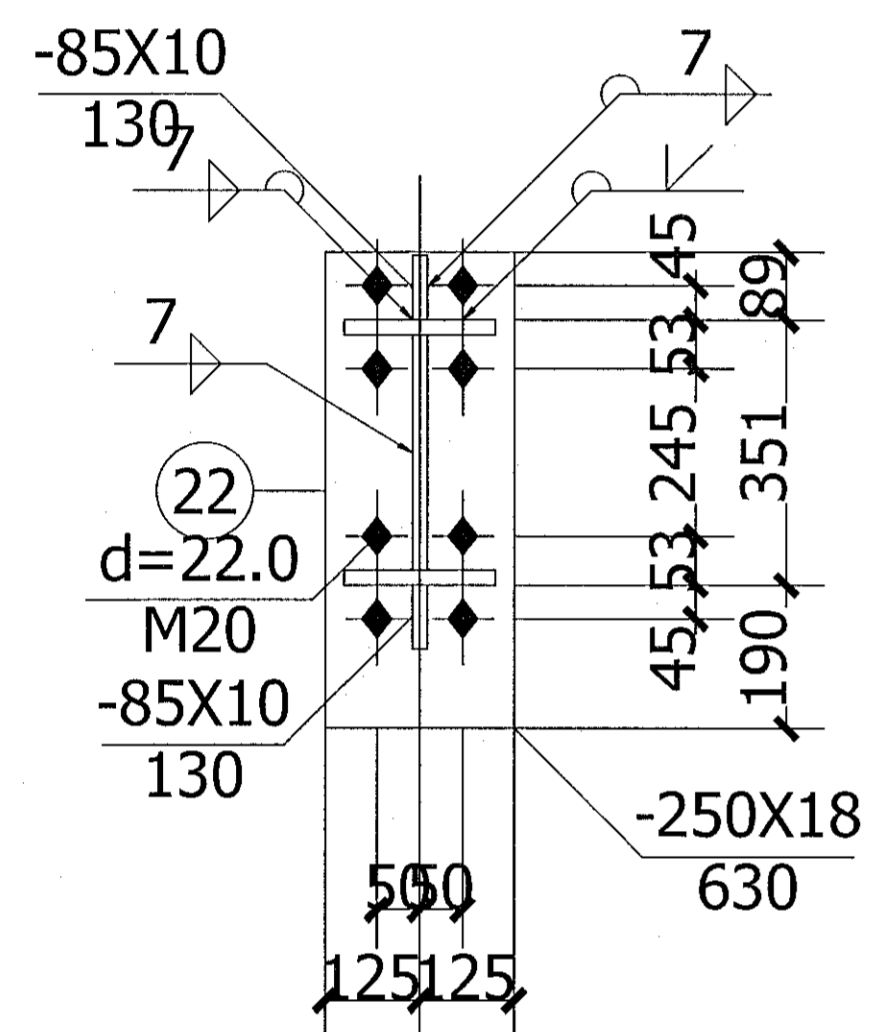

7-7

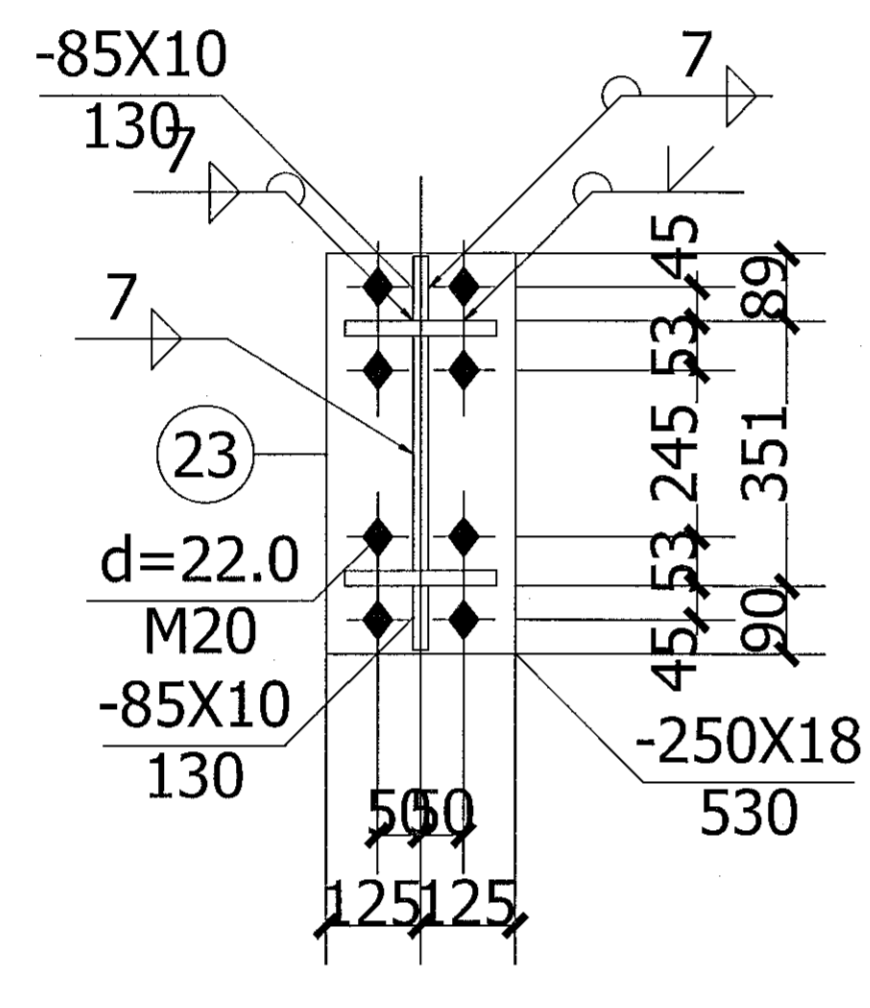

8-8

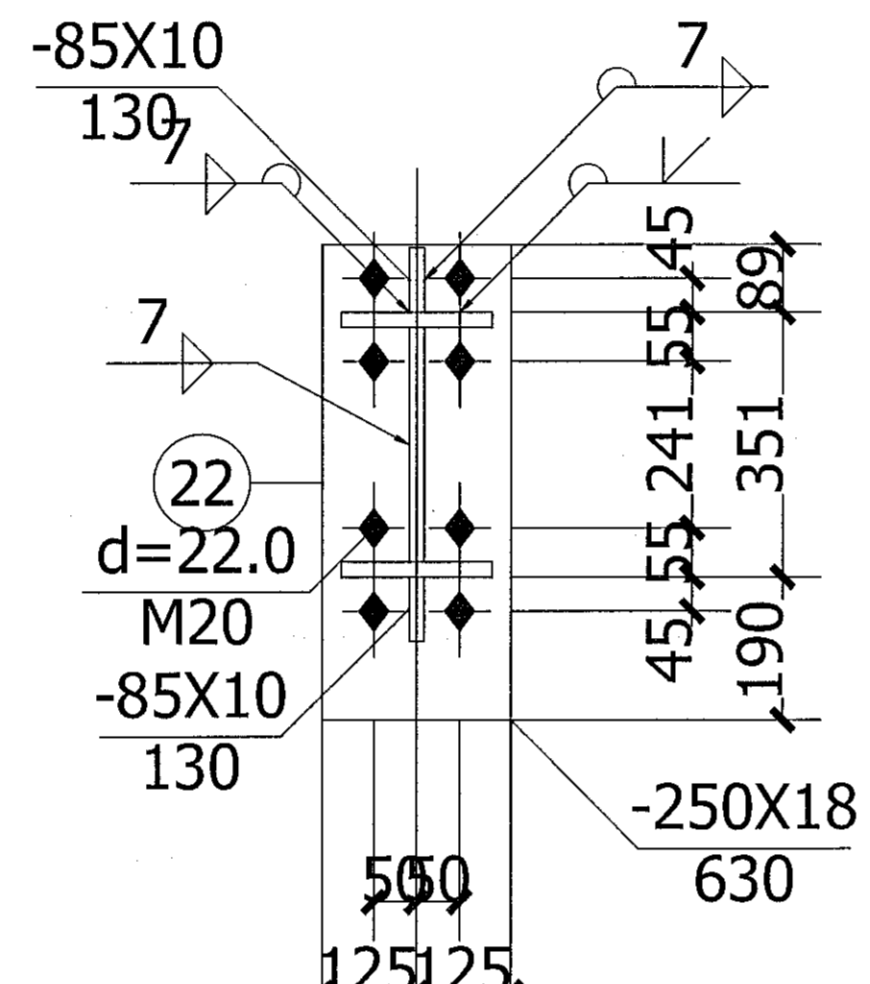

9-9

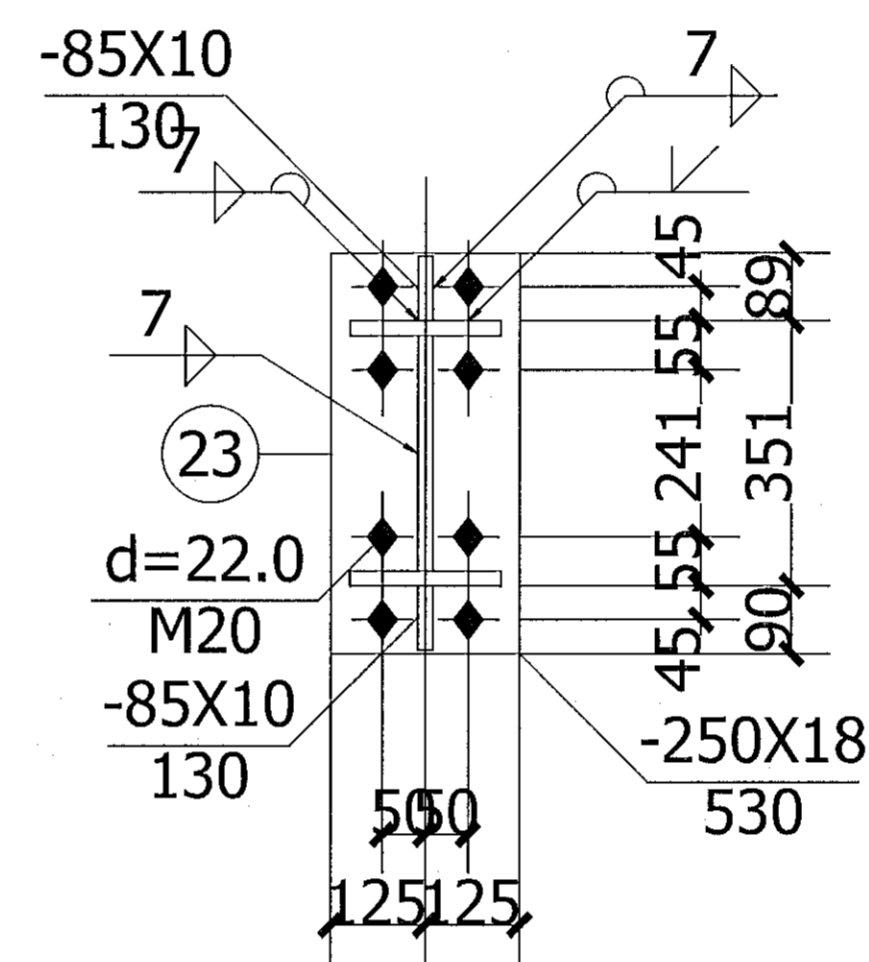

10-10

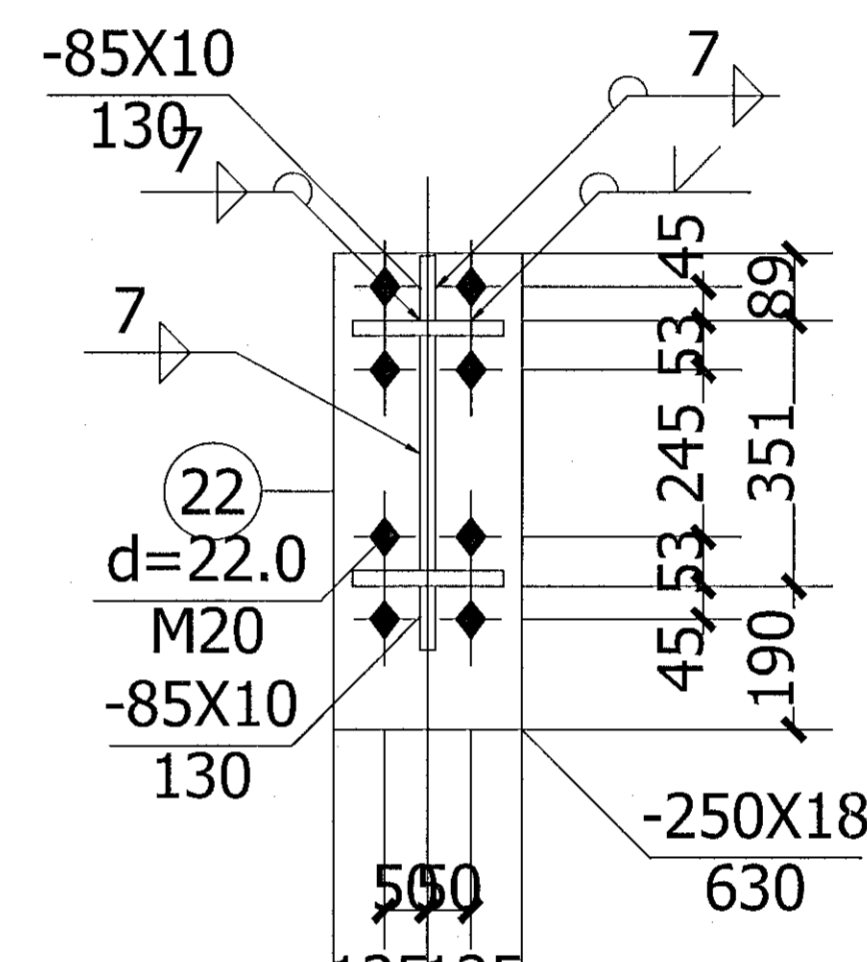

11-11

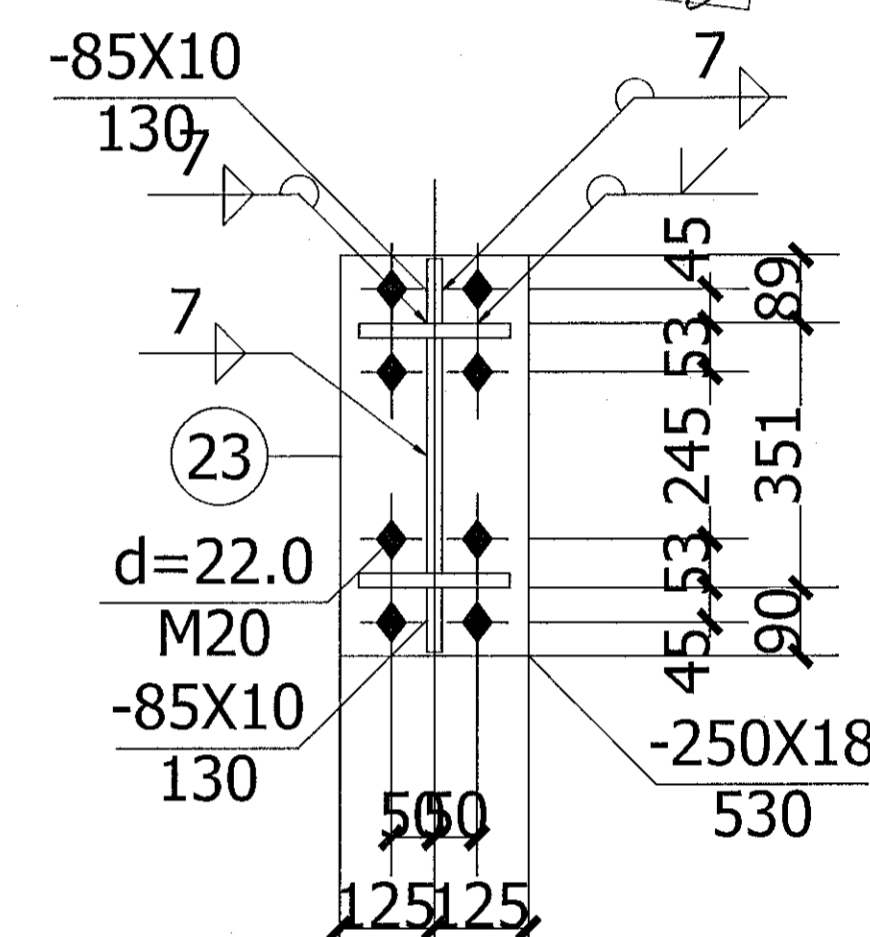

12-12

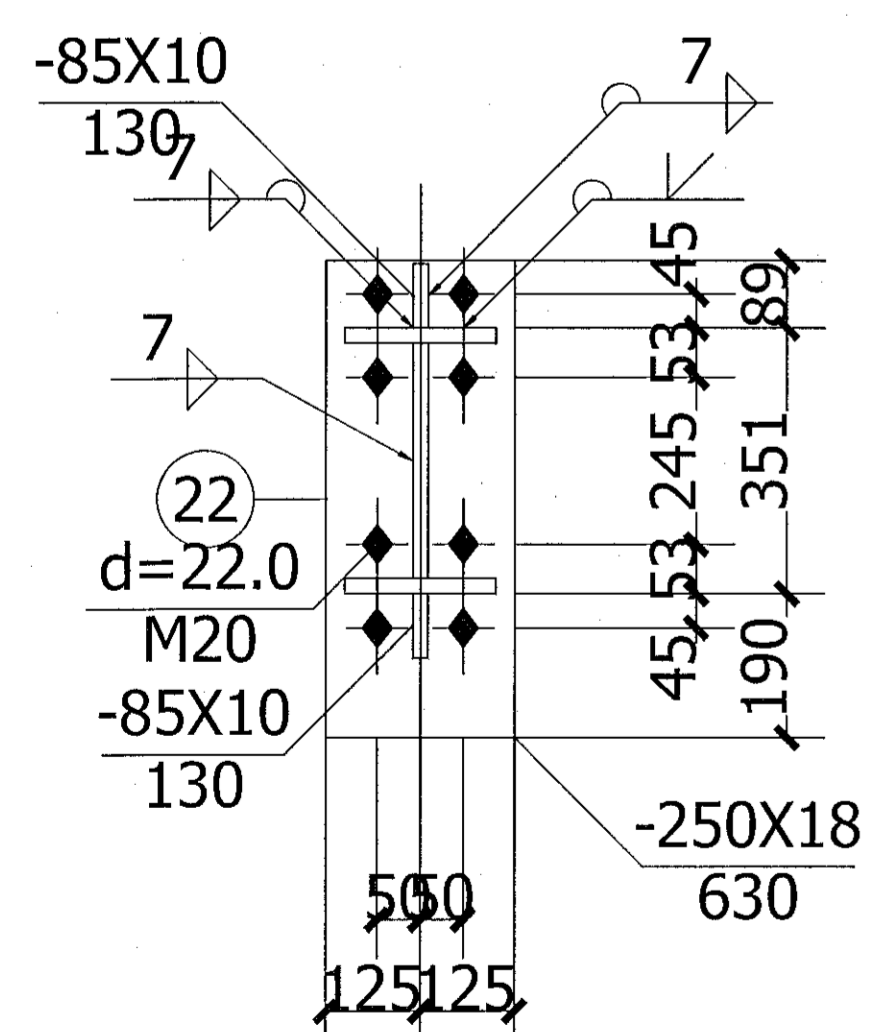

13-13

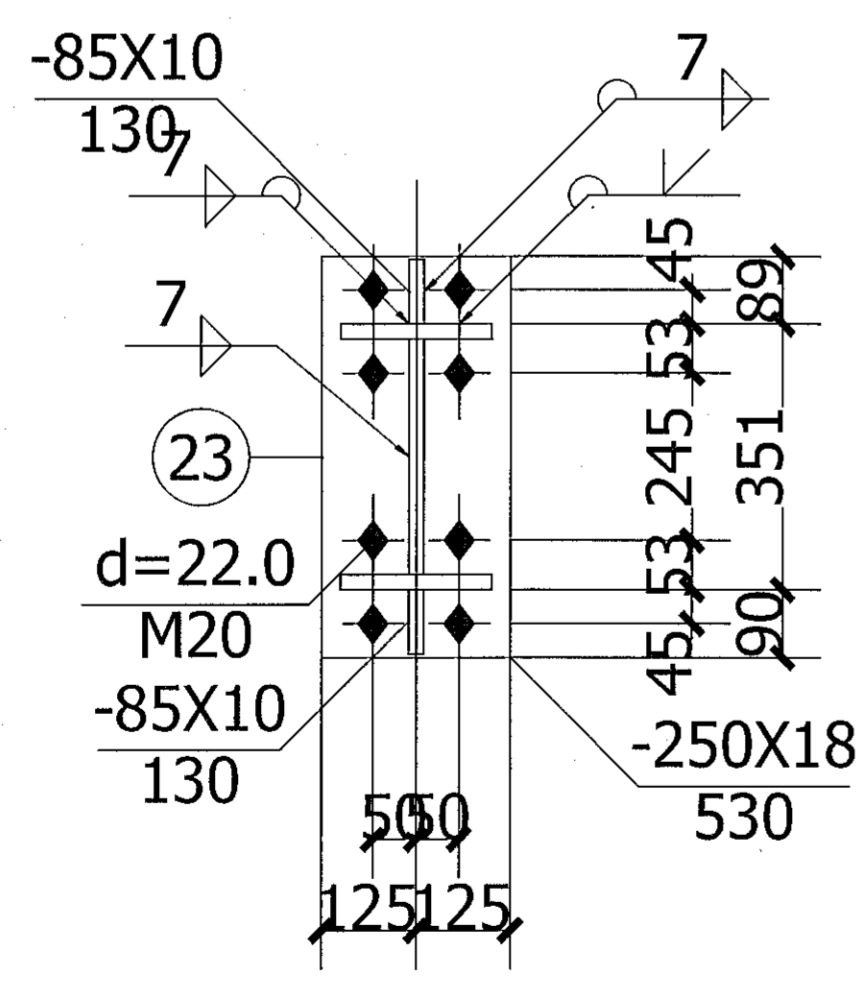

14-14

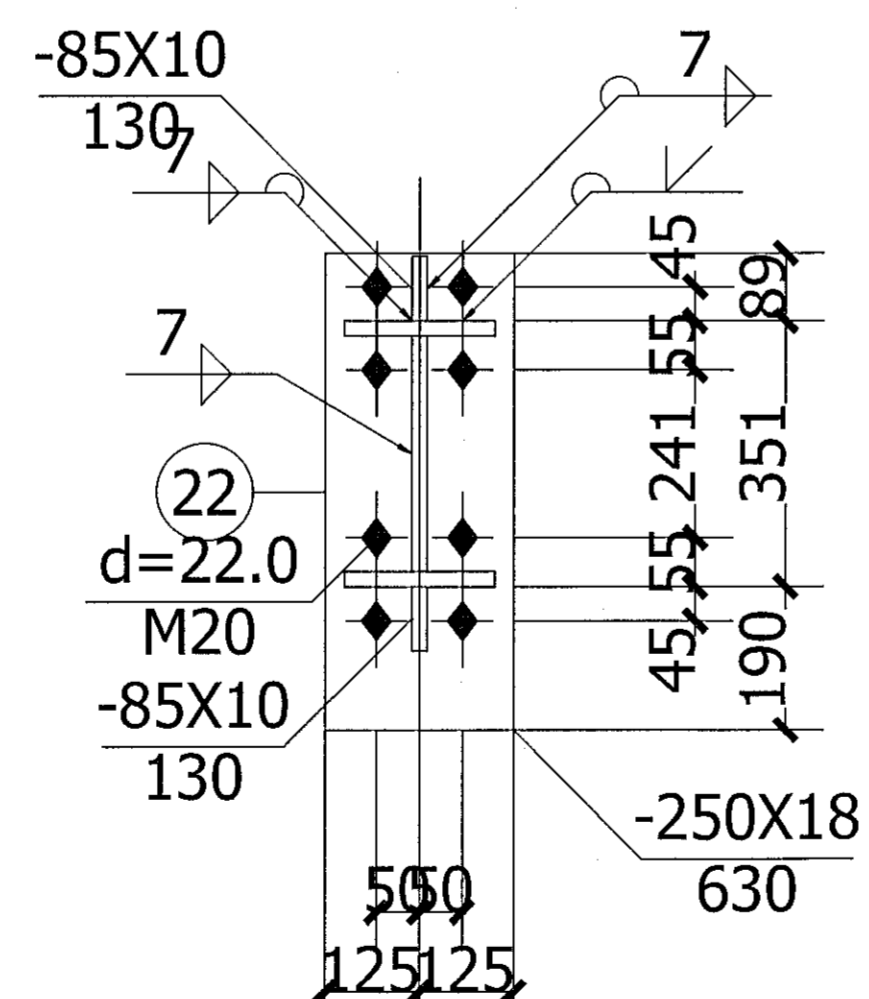

15-15

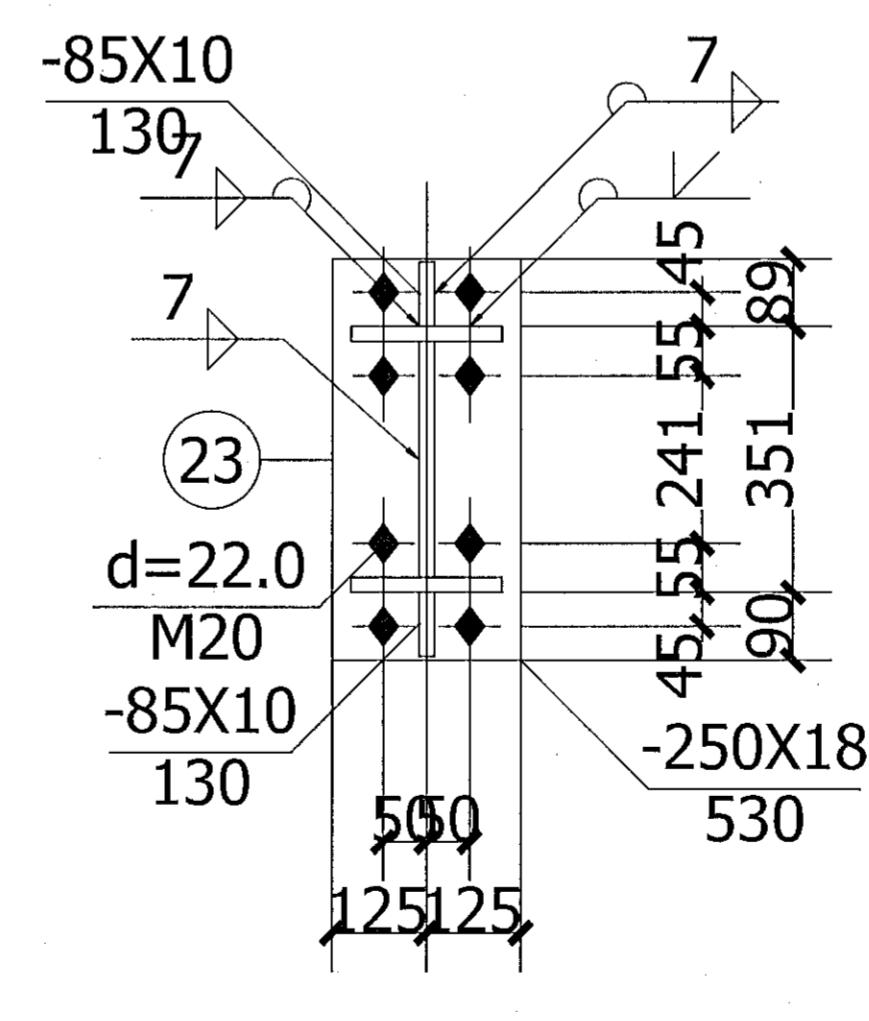

16-16

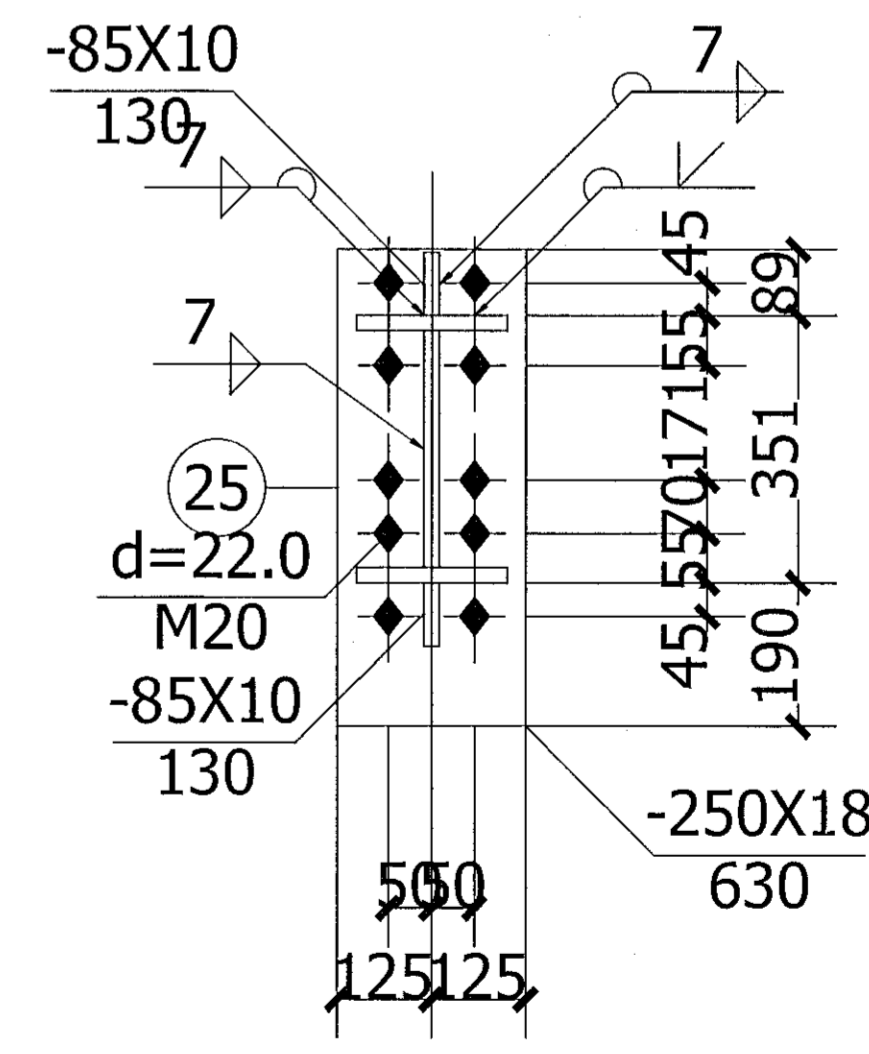

17-17

BREYTINGAR			

TILVÍSANIR:
SKÝRINGAR..... SJÁ TEIKN. NR. I-01

[Signature]

Reikn.	JKR	Sept. '18	Útgefið:	09.10.2018
Teikn.	JKR	Sept. '18	Skala:	1:10
Ath.				
Samþ.				
EINHELLA 2				Nr. 1-19
Verkhúti STÁLGRINDAVEGGIR, SÉRMYNDIR.		Verkfærðistofa Jóns Kristjánssonar ehf. Ardala 19 108 Reykjavík Sími: 537-0002 Fax: 772-3154 Út: 540817-0300 Netfang: jakns9@gmail.com		