

Grunnmynd 2. hæð  
1 = 50 mm

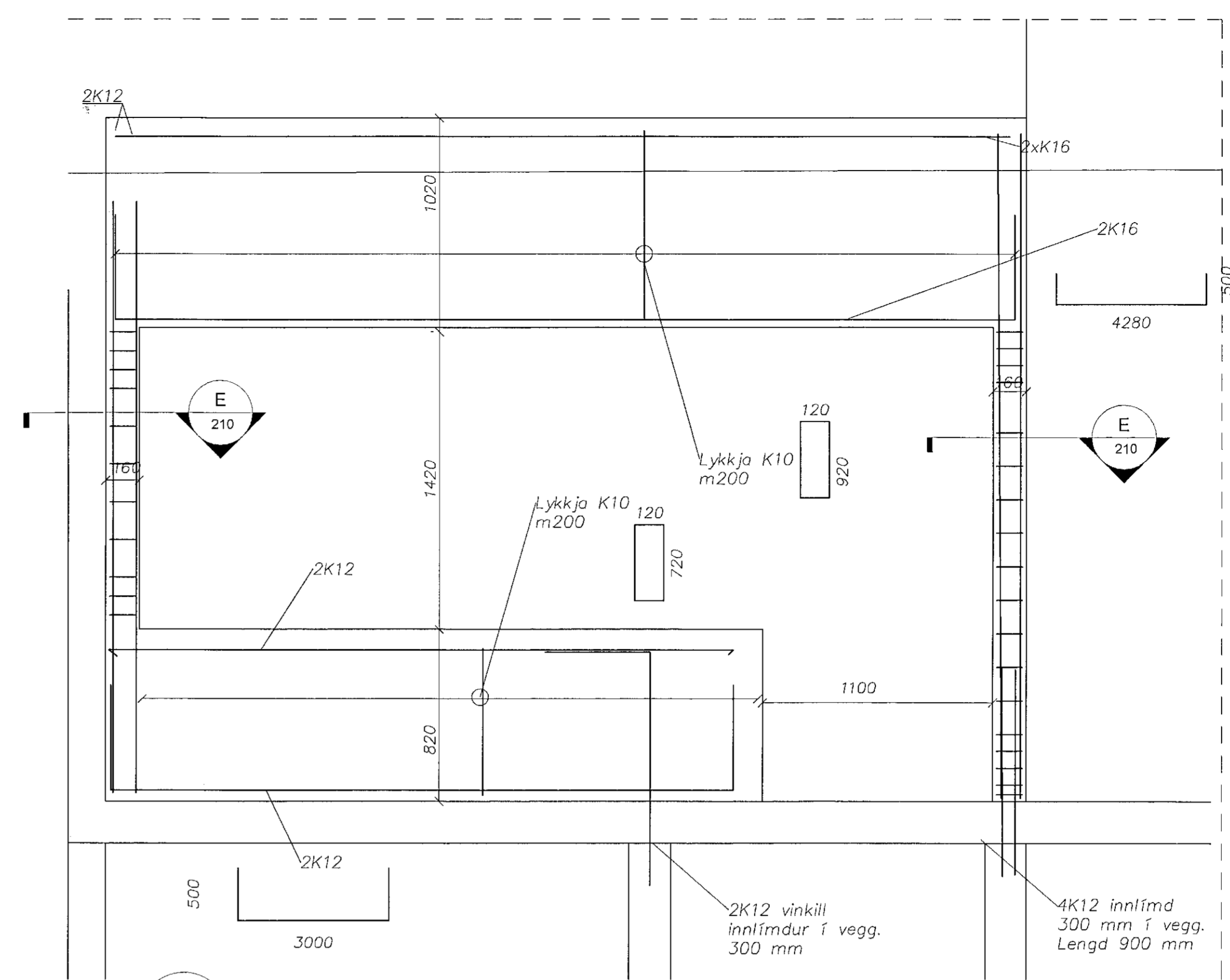

B Ásýnd  
1 = 20 mm

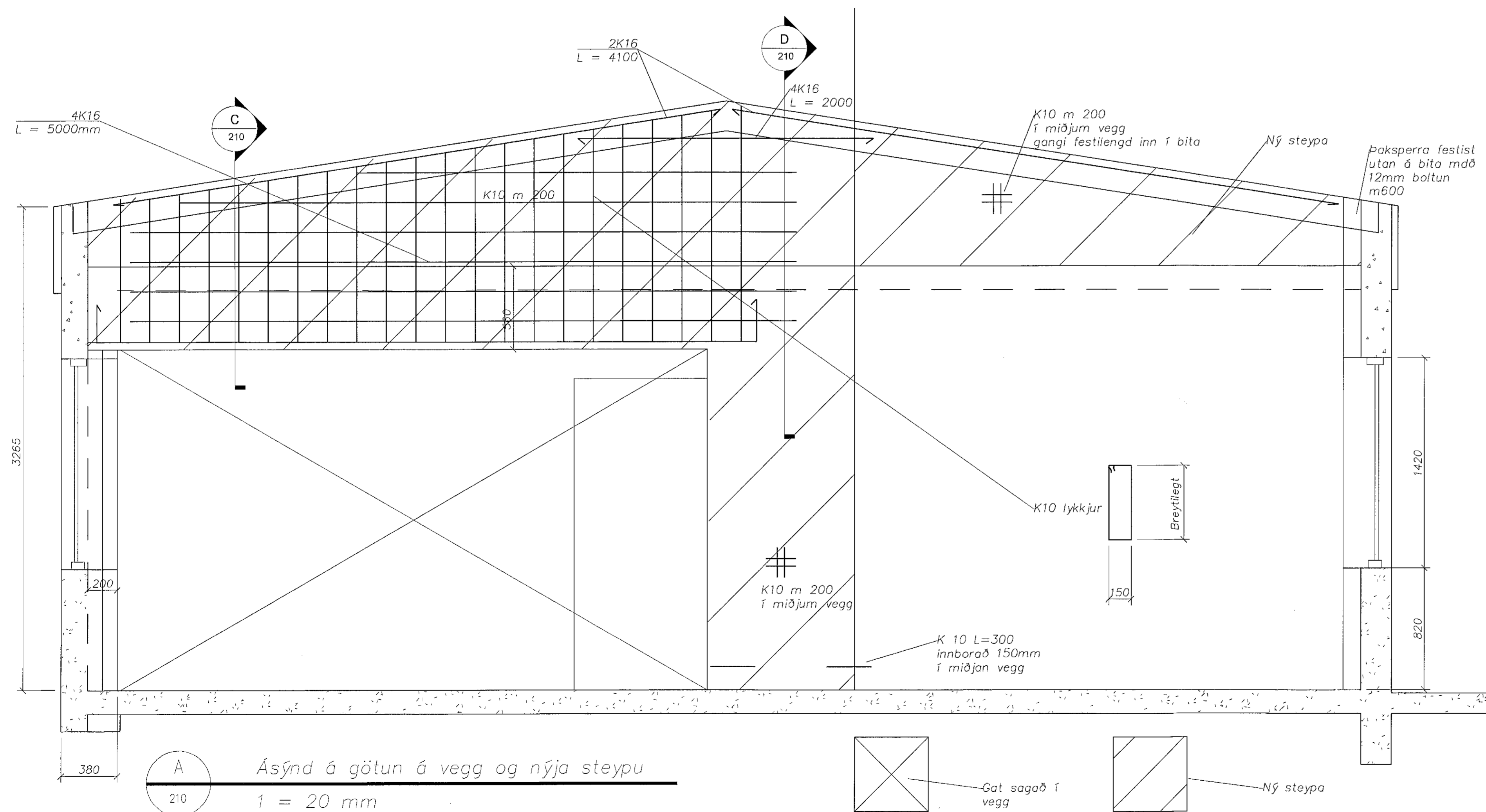

A Ásýnd á götun á vegg og nýja steypu  
1 = 20 mm

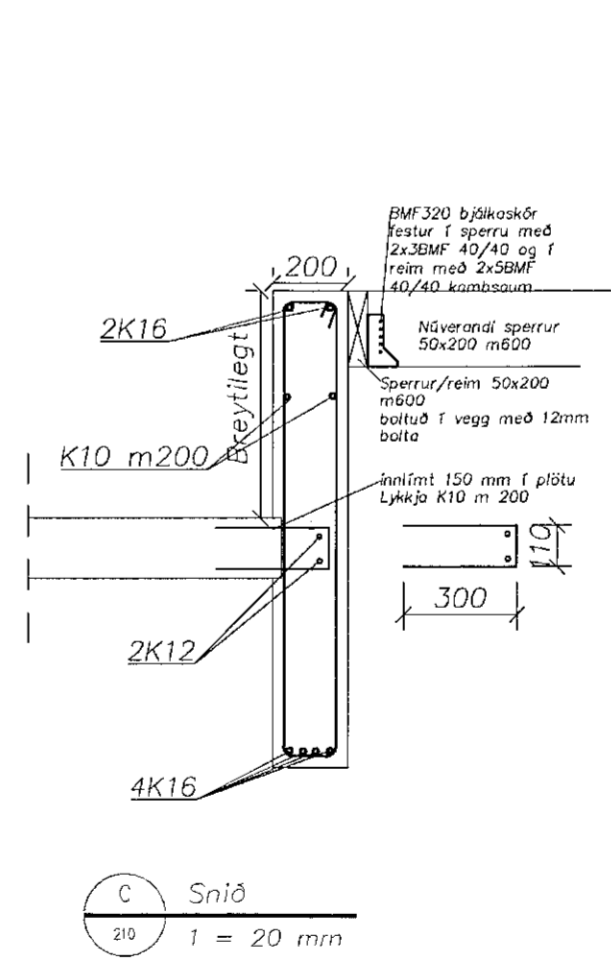

C Snið  
1 = 20 mm

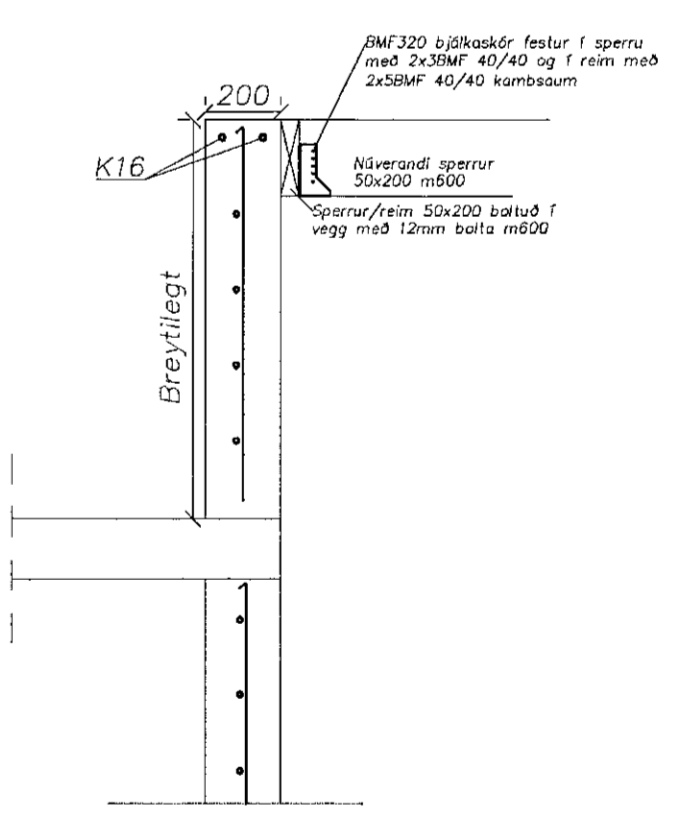

D Snið  
1 = 20 mm

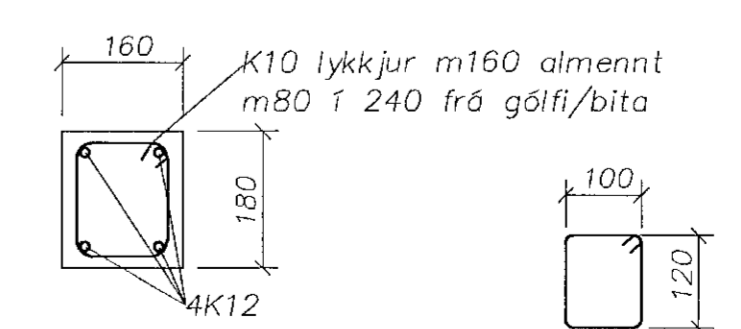

E Snið  
1 = 10 mm

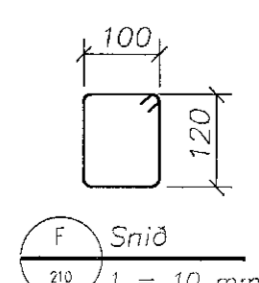

F Snið  
1 = 10 mm

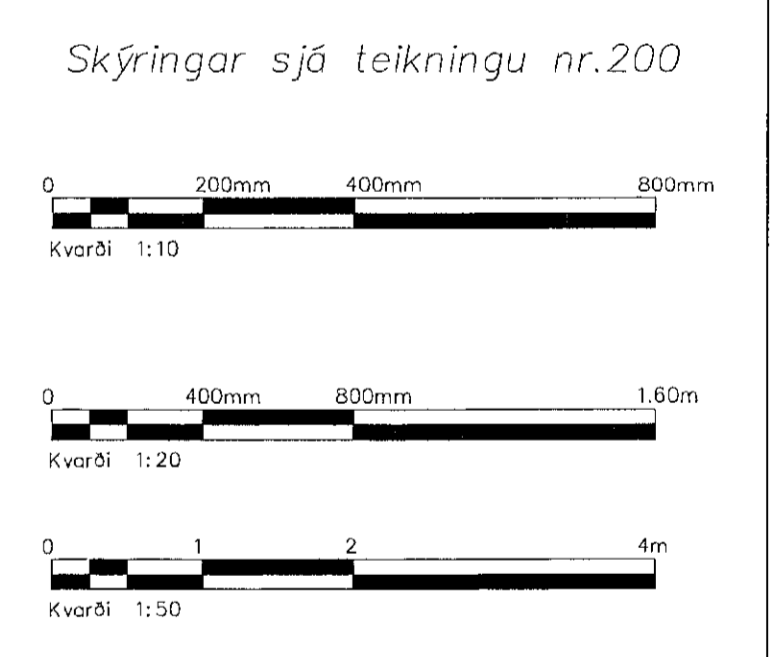

B	Blendingu bita breytt	PVG	20.08.2019
A	Verkeikning	PVG	23.07.2019
Úg.	Breyting	Höfundur	Dags.

**Verkeikning**

Strendingur ehf.  
verkefnabjónusta

Flydugata 13-15  
201 Hafnarfirði  
Sími: 575-5640  
www.strendingur.is  
strendingur@strendingur.is

I samráði við aðalskipulætt frá:  
Dagsetning og útgáfa aðaluppdráttar:  
Höfundur: Pétur Vilberg Guðnason kl.051183-2739  
Höfundur: Pólinn Kl.0501-4729

**Dalshraun 13, Hafnarfirði**  
2. hæð breyting á burðarvirki

Teiknad / Harnad:	Dags:	
PVG		23.07.2019
Kvart:	Útgáfa:	Nr. teikningar: Stærð:
skv. teikn.	B	210 A1