

Samþykkt þann  
17. nóv. 2020  
F.h. byggingarfulltrúans í Hafnarfirði  
Sigurður Steinar Jónsson

Dags:	Nr.	Breytingar:	Samb.

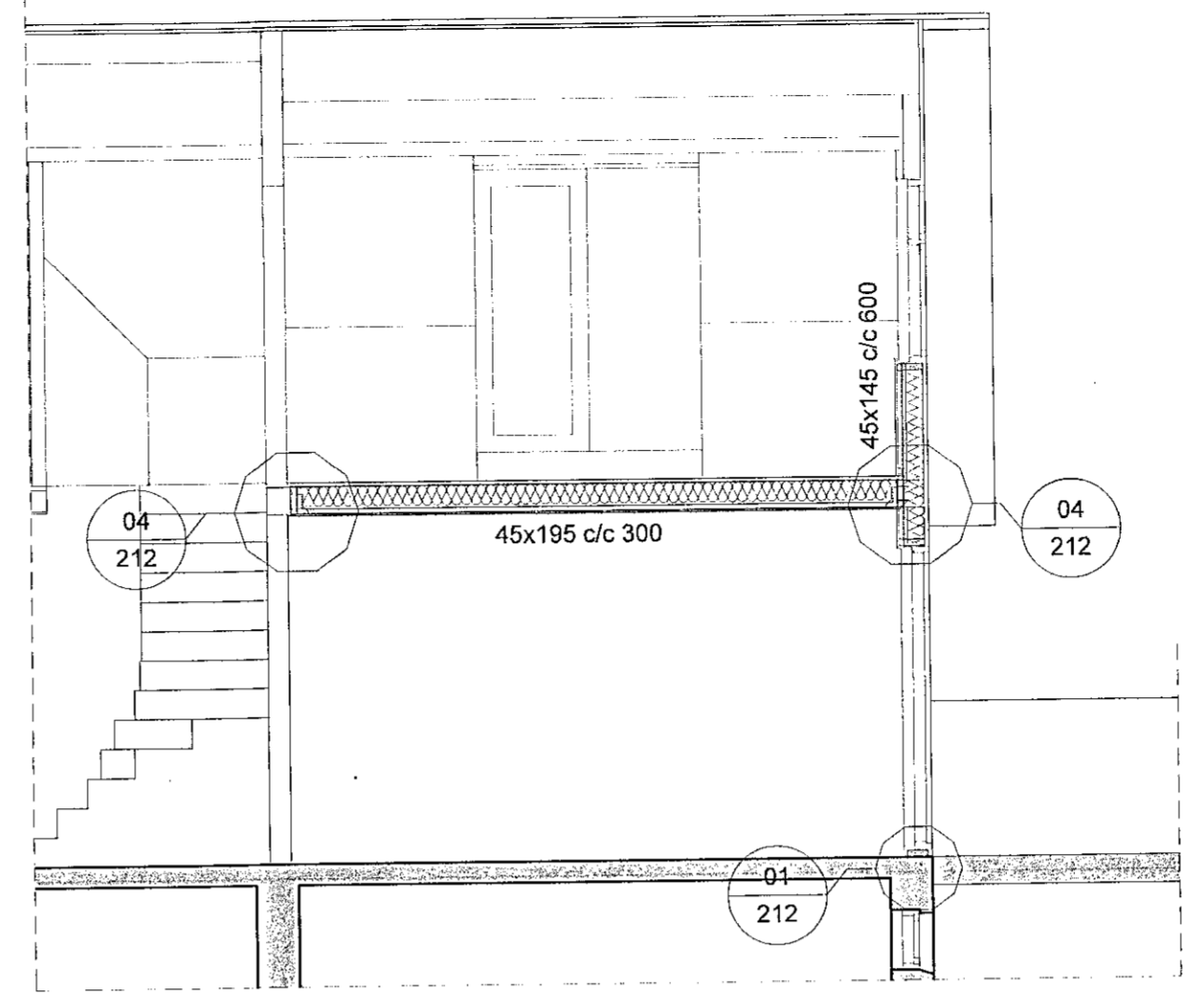
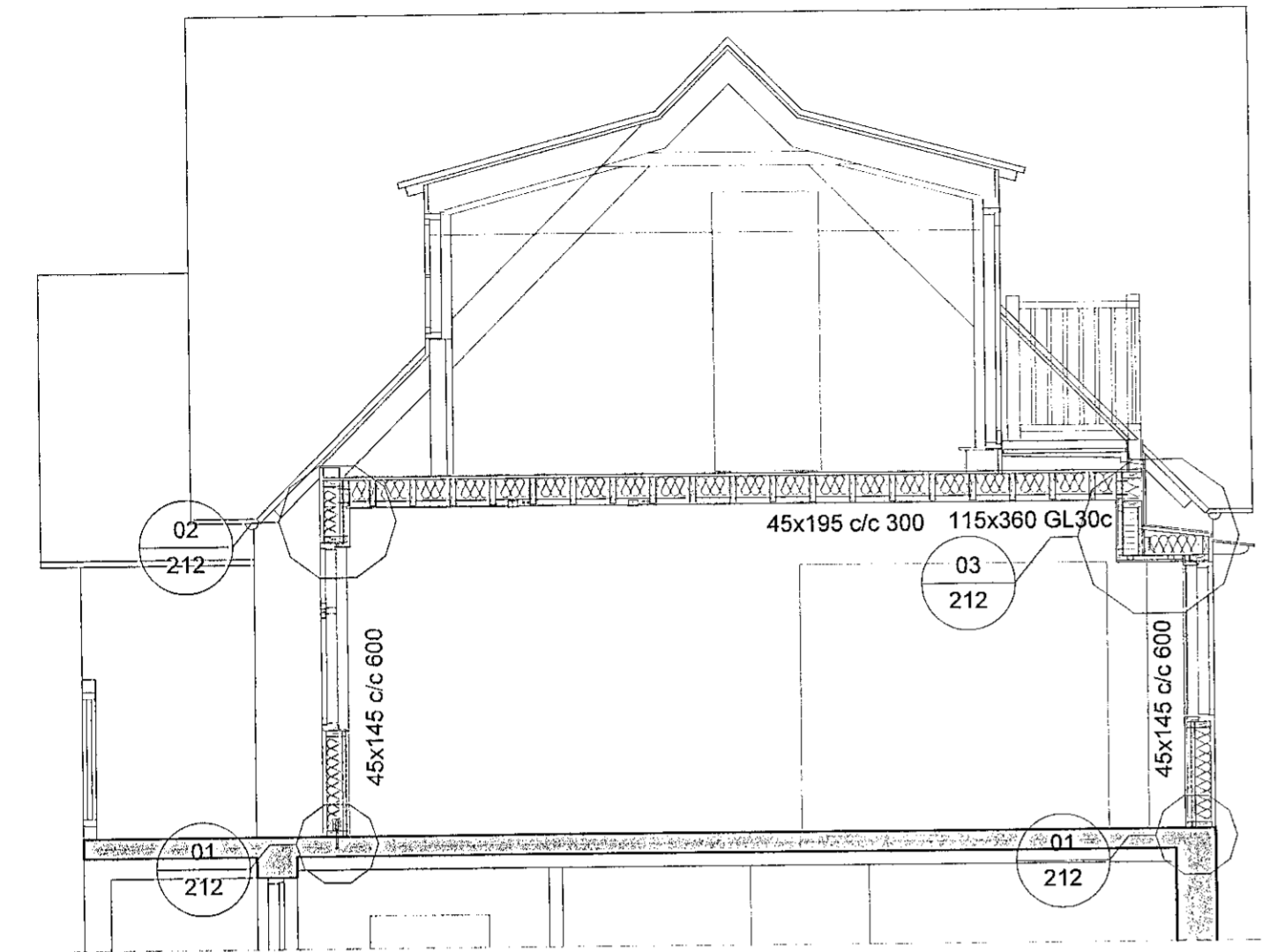

A Snið  
211 1:50

B Snið  
211 1:50

BMF 90 vinkill neglist með 2x4  
stk. 40/40 kambsaum í stoðir

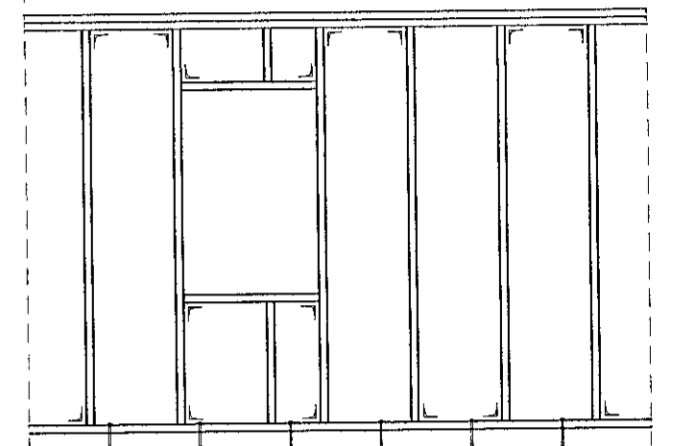

Dæmigerður frágangur á vegg.

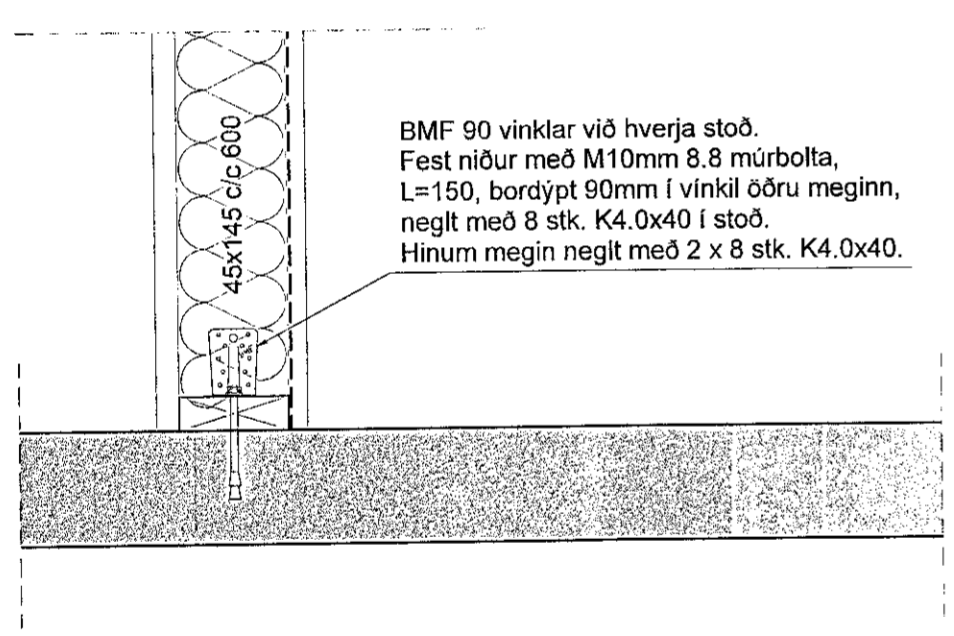

01 Deili  
212 1:10

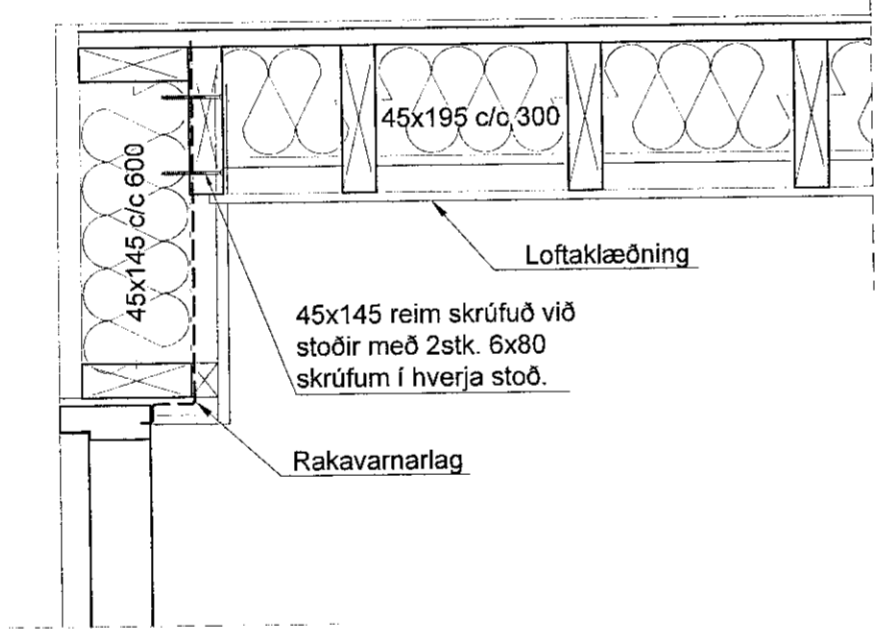

02 Deili  
212 1:10

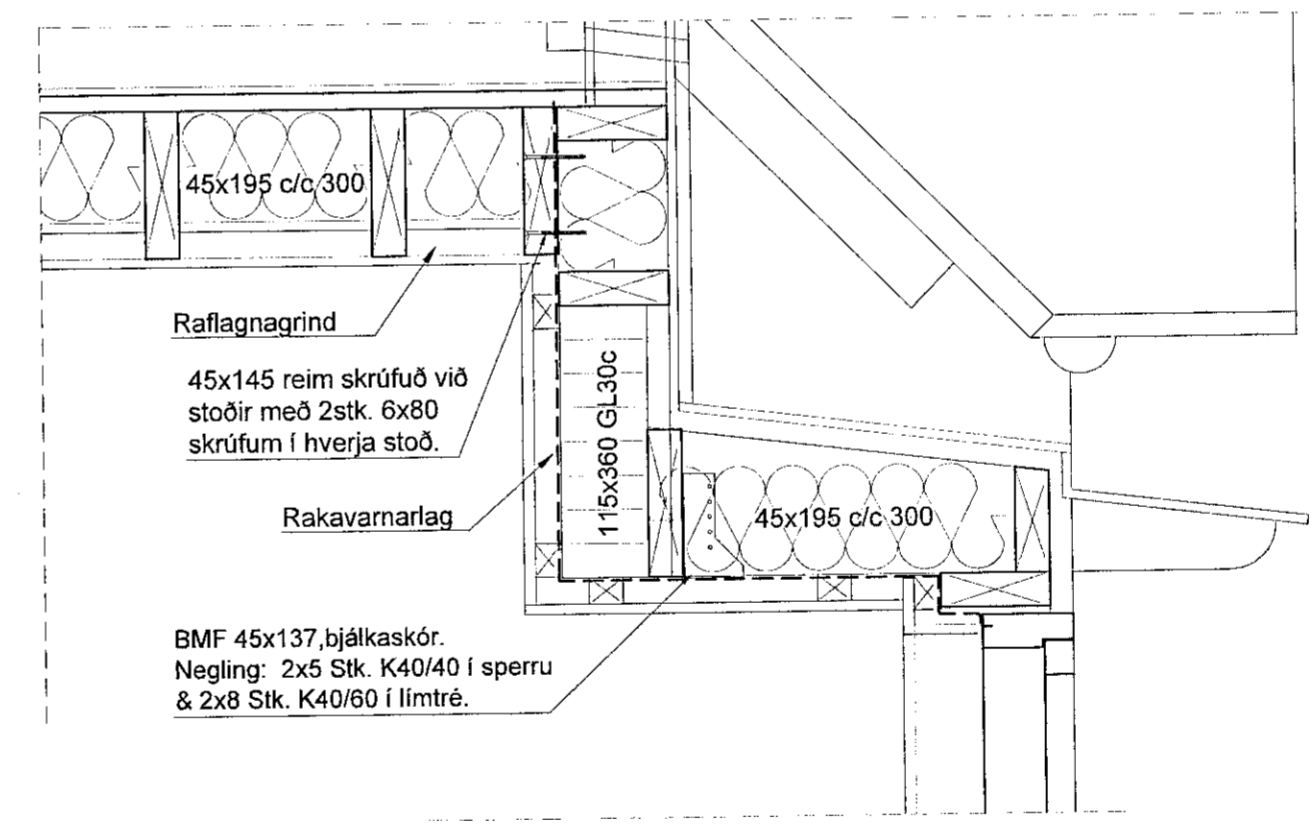

03 Deili  
212 1:10

Nota skal 9mm grenikrossvið eða sambærilegt á vegg. Negla skal krossvið með 50mm (2") heitgalv. saum, 200mm á milli nagla í hverja veggjastoð og 150mm á milli í fótrem.

45x145 skal nota í veggjagrind og reimar.

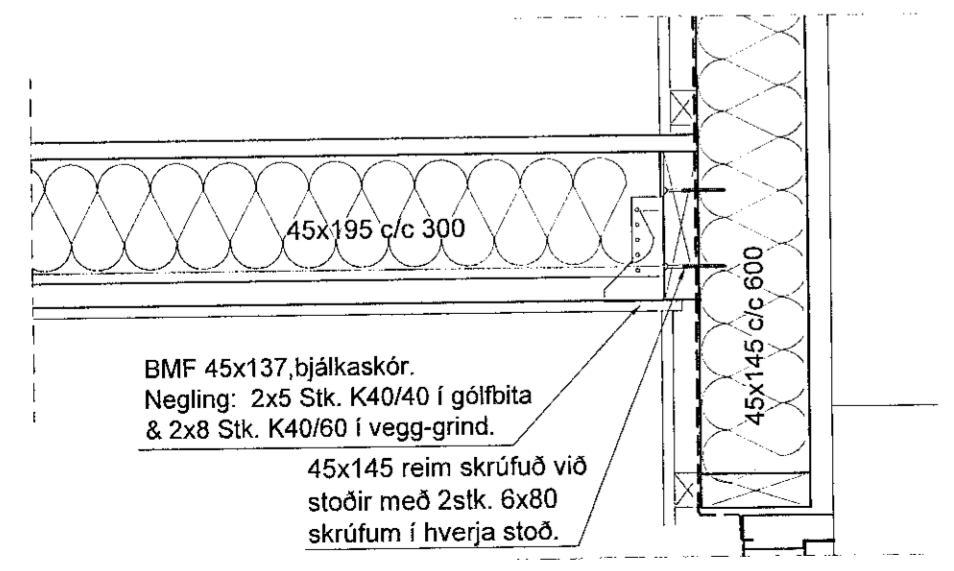

04 Deili  
212 1:10

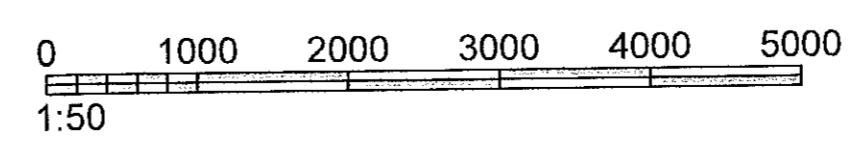
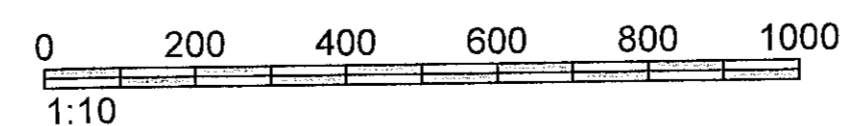
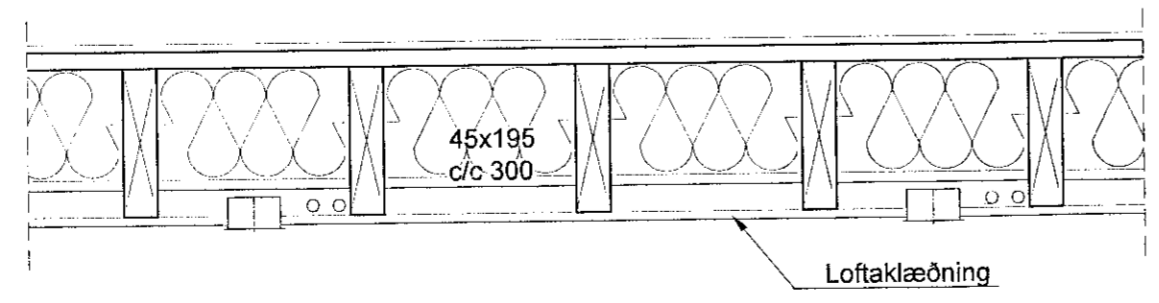

Skýringar sjá teikn. nr. 200

**VERKHOF EHF**

Fellsmúli 26 • 108 Reykjavík • Sími: 517 9050 • Netfang: verkhof@verkhof.is

Heiti verks: <b>Norðurbraut 27 - Viðbygging</b> 220 Hafnarfjörður		Höfundur: Svavar M. Sigurjónsson 180067-3419 Björgvin Ó. Sigurjónsson 110481-5279	Dags: 01.10.2020
Heiti teikningar: Burðarbol Grunnmynd Snið og deili		Samþykkt: <i>Svavar M. Sig.</i>	Verknúmer: 19-105
Formaði: SMS		Áðalhönnuður: Ólaf Flygenring 109955-4659	Mælikv: 1:50/10
Teiknari: SMS	Mælt:	Yfirfand: BÓS	Teikna.nr.: 212