

ÁSÝND A.A, RÝMI 1-63

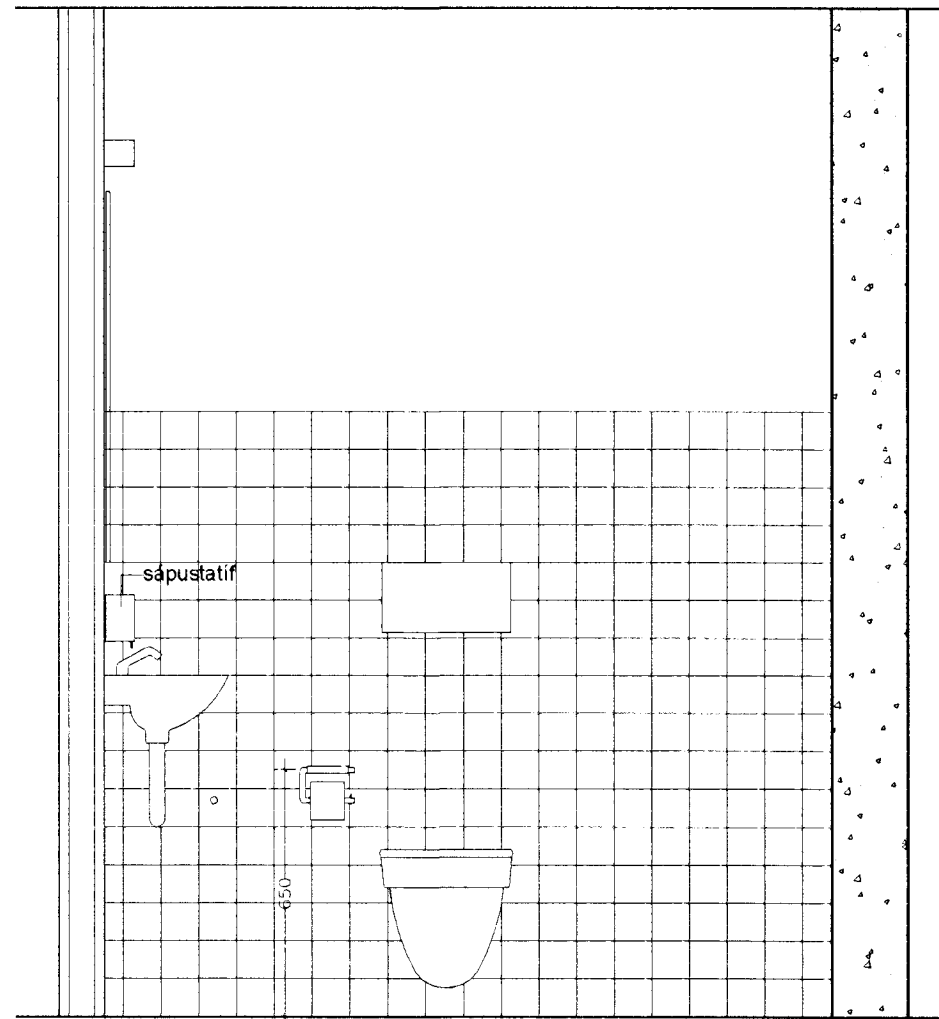

ÁSÝND B.B, RÝMI 1-63

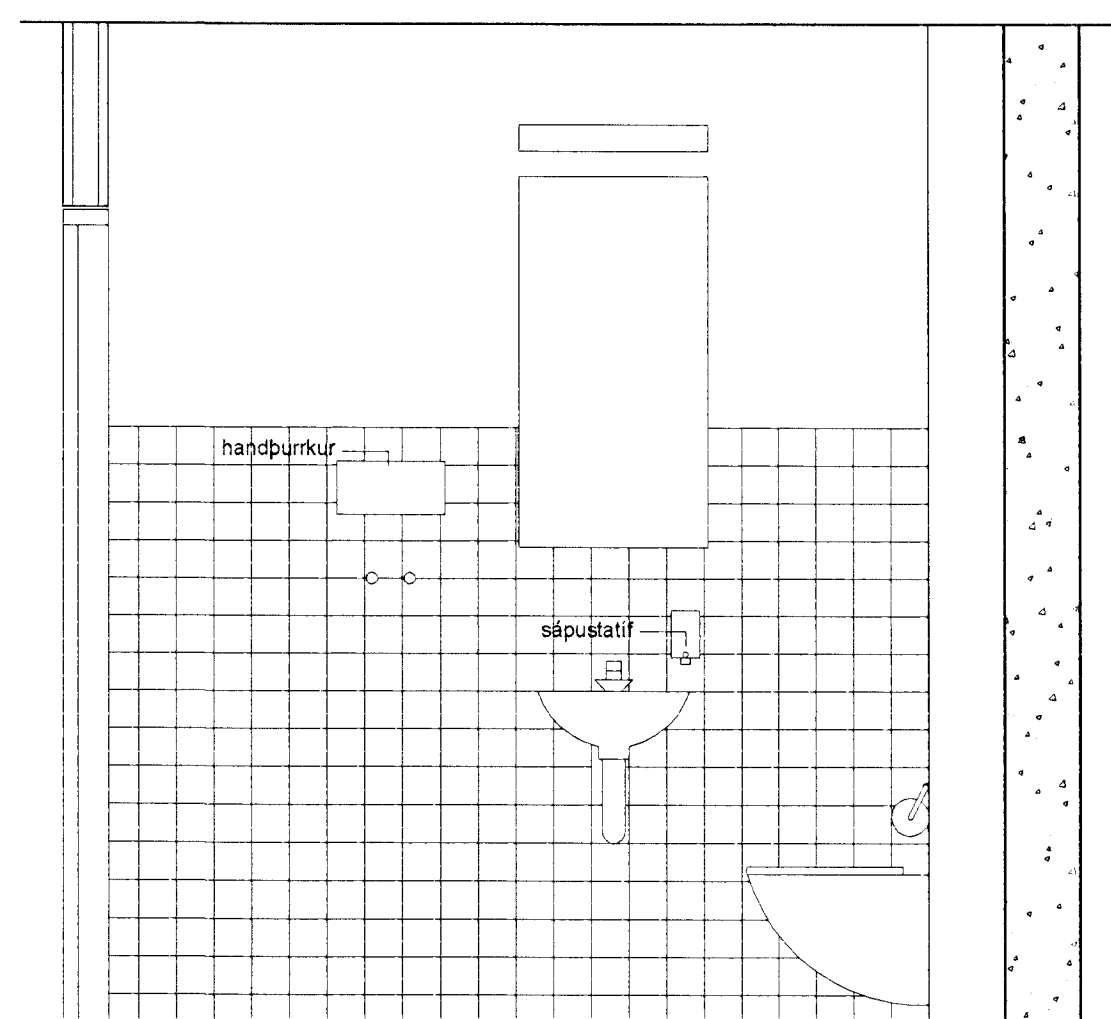

ÁSÝND A.A, RÝMI 1-65

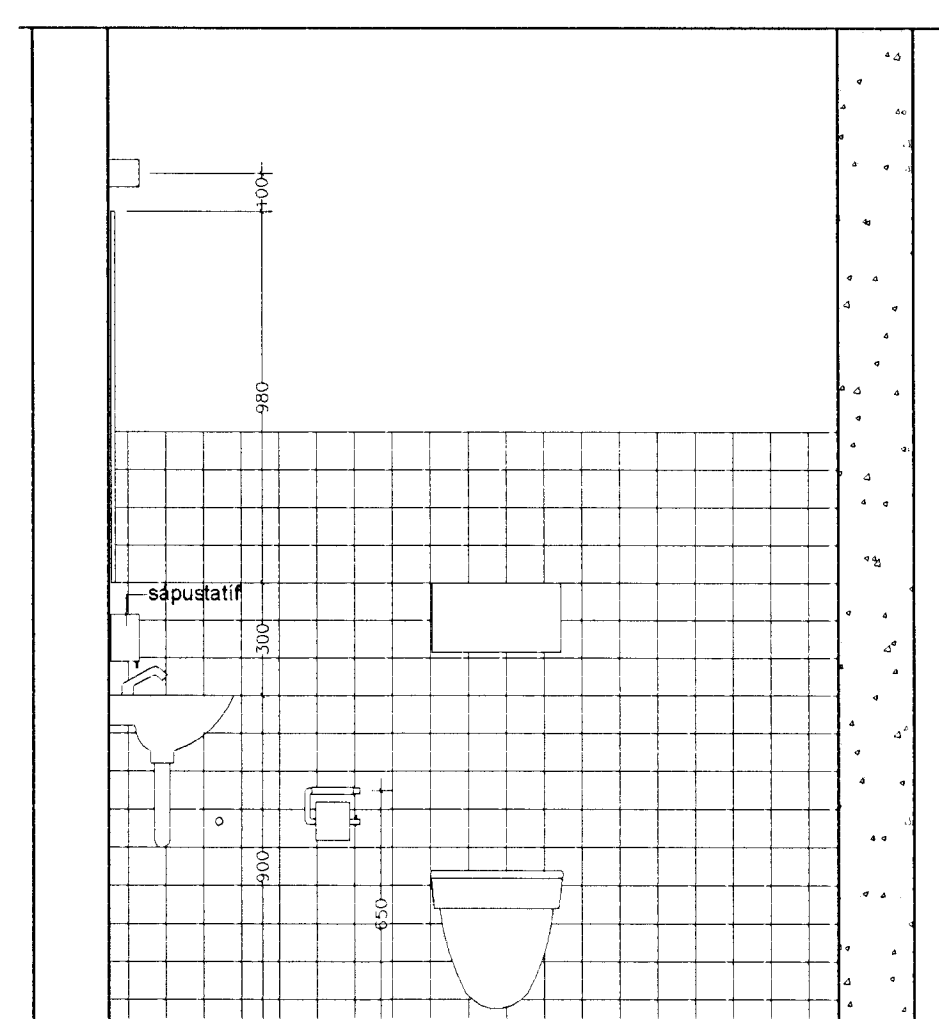

ÁSÝND B.B, RÝMI 1-65

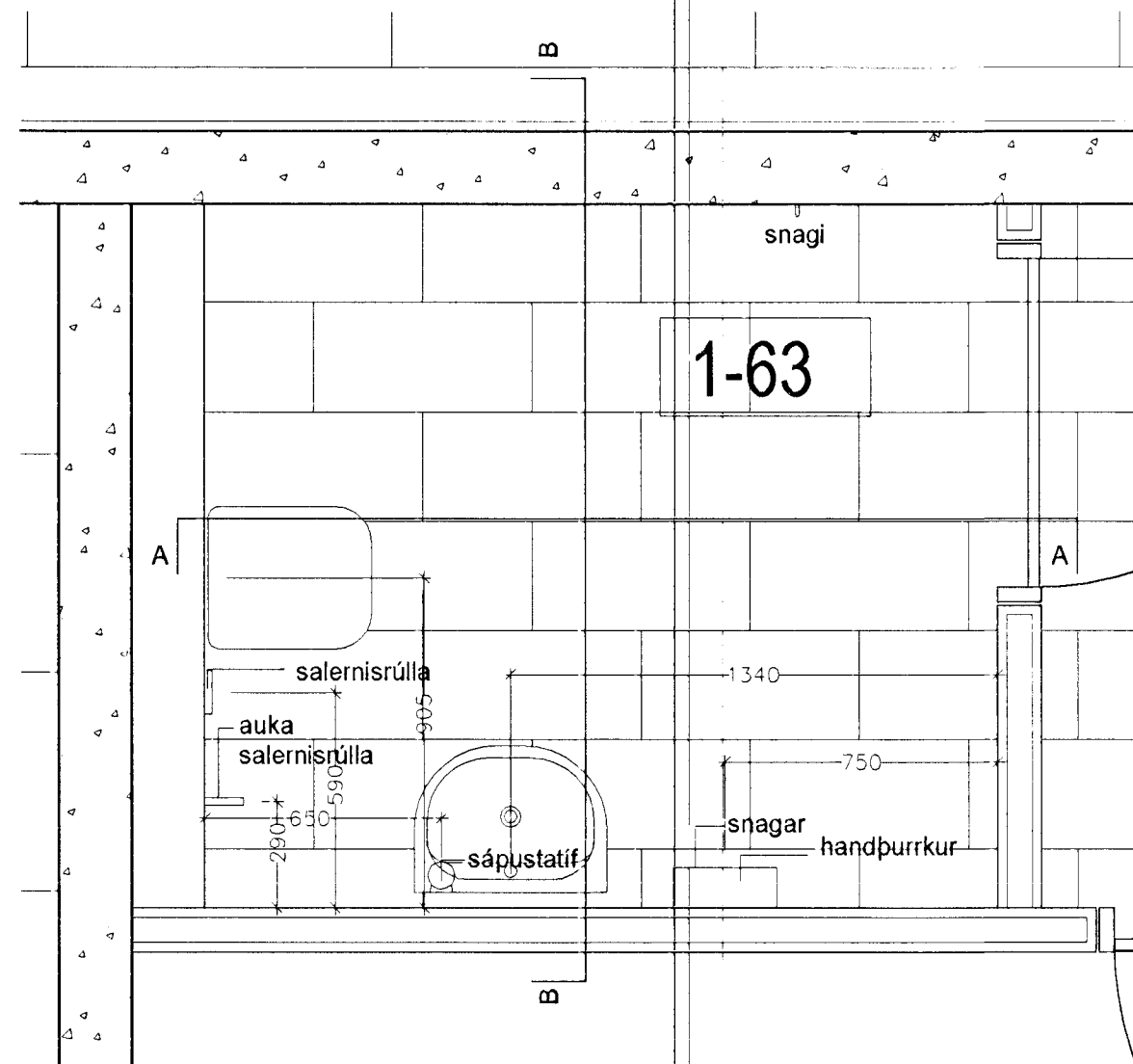

GRUNNMYND RÝMI 1-63  
SNYRTING FATLAÐRA

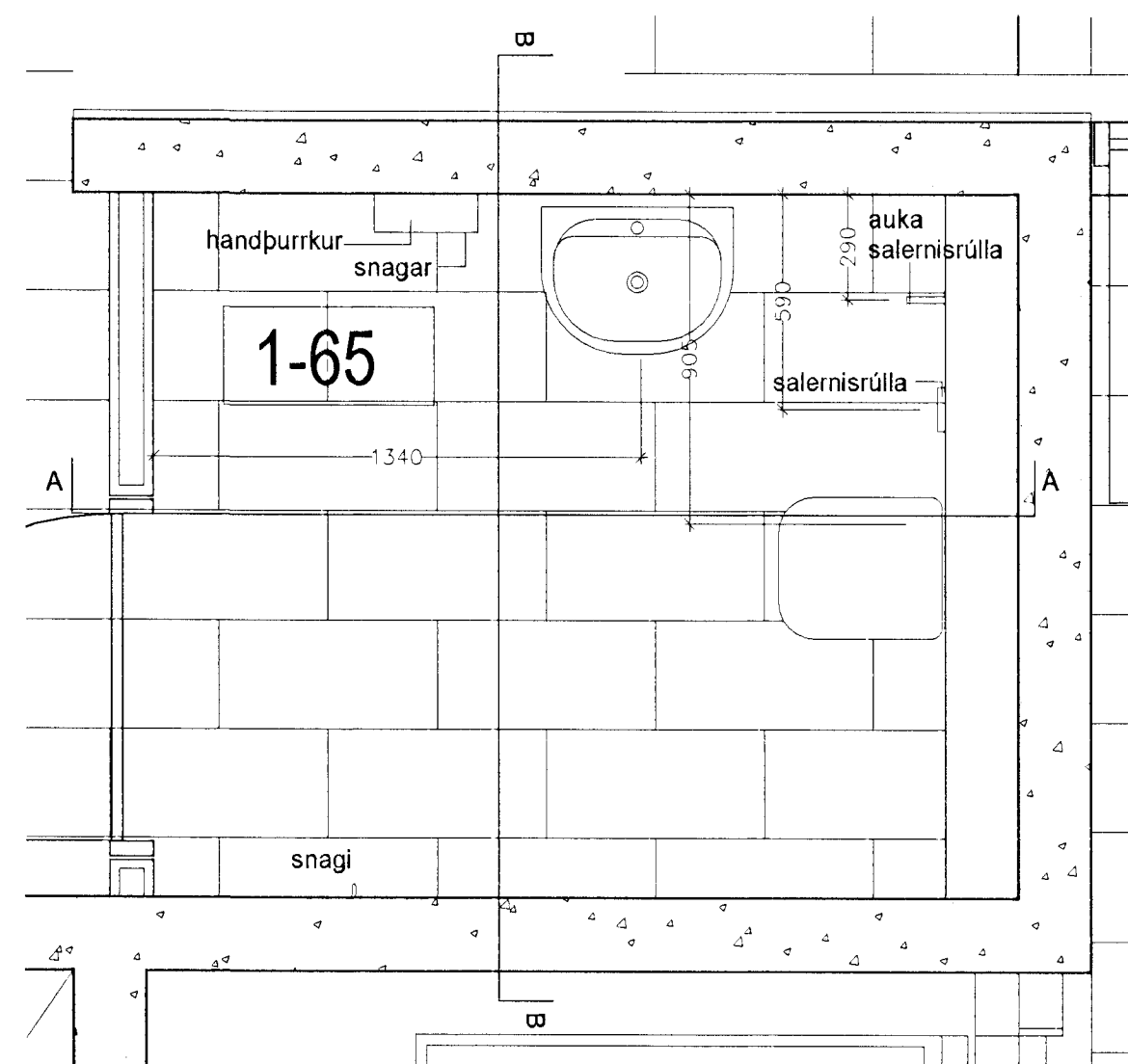

GRUNNMYND RÝMI 1-65  
SNYRTING FATLAÐRA

*Sigríður Ólafsdóttir 071070-5069*

BR DAGS BREYTING REIKN TEIKN

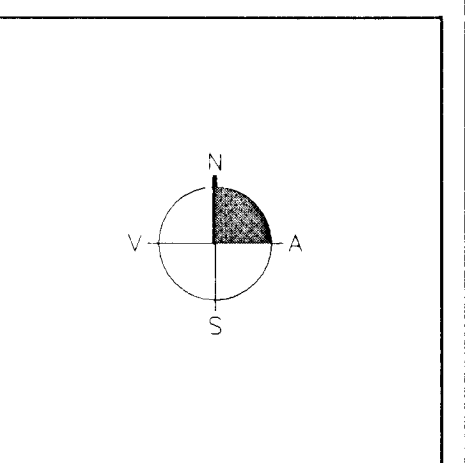
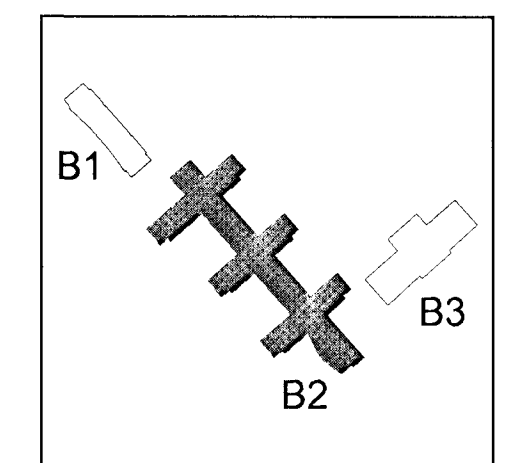

**ARKITEKTAR**  
BERGSTADASTRÆTI 10, RVK  
Sími 551-1460, netfang arkitekt@shof.is

**FINNUR BJÖRGVINSSON**  
**HILMAR ÞÓR BJÖRNSSON**  
**SIGRÍÐUR ÓLAFSDÓTTIR**

**LANDMÖTUN**  
EINAR E SÆMUNSEN  
INGIBJÖRG KRISTJÁNSDÓTTIR  
MARGRÉT SIGURDARDÓTTIR

**VSO**  
VSO RÁÐGJÖF

03 JUNI 2002  
VG

**SÓLVANGSVEGUR 4**  
**LÆKJARSKÓLI**

INNRETTINGAR  
SNYRTINGAR FATLAÐRA  
RÝMI 1-63, 1-65  
GRUNNMYNDIR, SNID, ÁSÝNDIR

HANNAÐTEIKN  
ATH  
SAMÞYKKT  
KT

SÖHISK  
660584.1399

KVAÐI 1:20  
VEIÐIR

TEIKN NR.  
REYKJAVÍK

BR

B2-A-VI-026