

Nr. 1 2 stk.

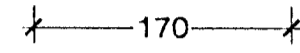

Nr. 2 1 stk.

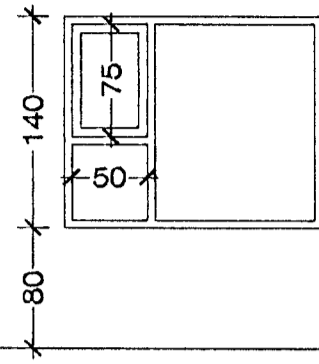
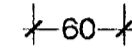
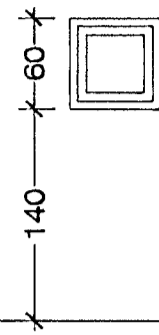

Nr. 3 1 stk.

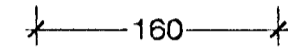
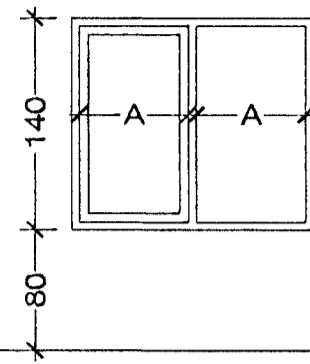

Nr. 4 1 stk.

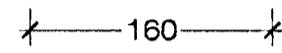
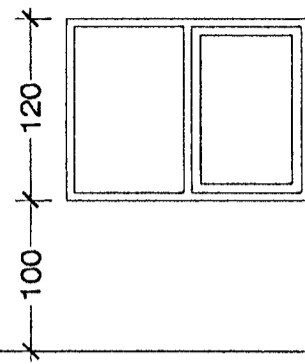

Nr. 5 1 stk.  
Sjá sérteikn. nr. 208

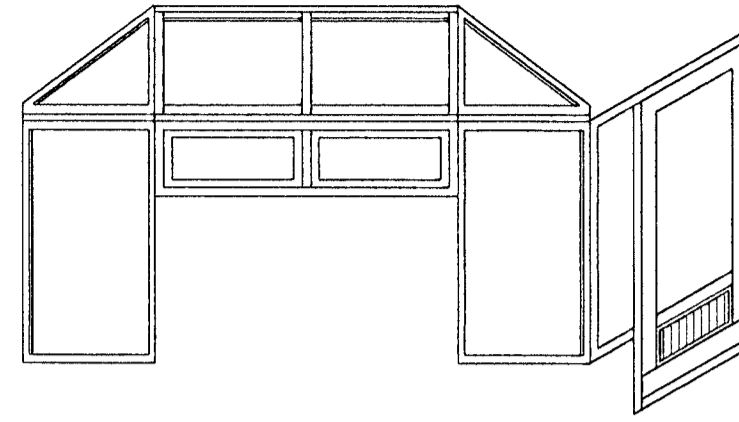

Nr. 06 1 stk.

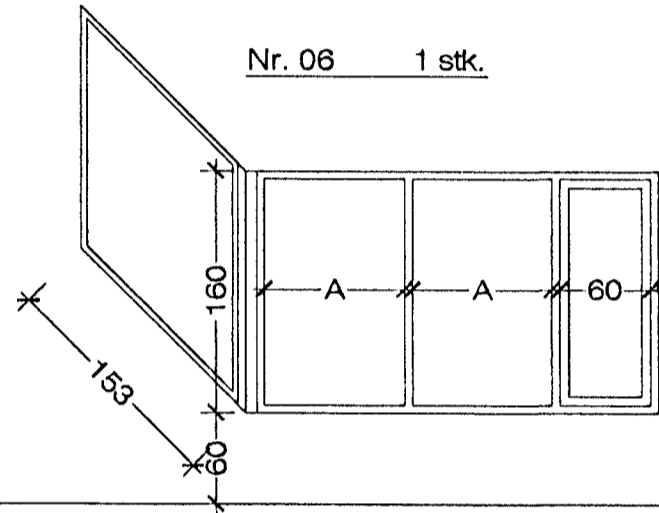

Nr. 07 1 stk.

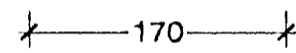
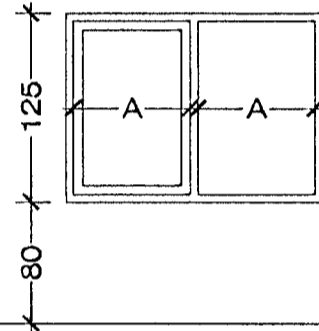

Nr. 08 1 stk.

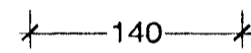
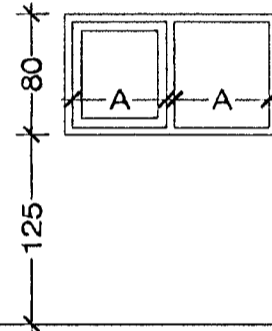

Nr. 09 1 stk.

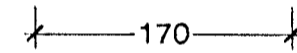
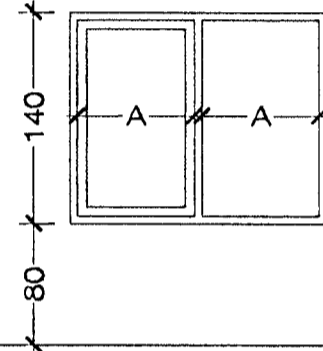

Nr. 10 1 stk.

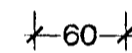
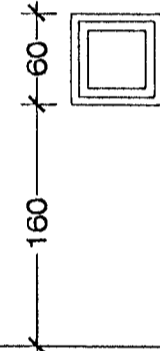

Nr. 11 2 stk.

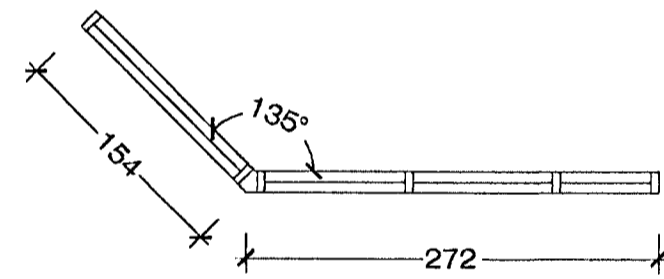
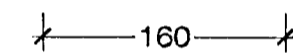
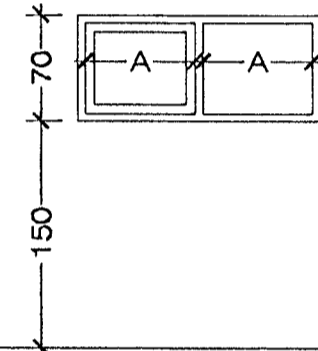

Útihurð 1 stk.

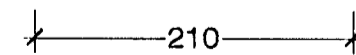
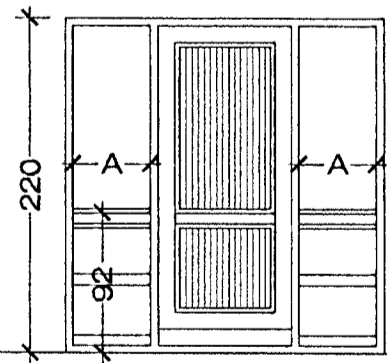

Svalahurð 1 stk.  
herb.

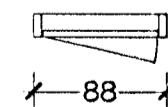
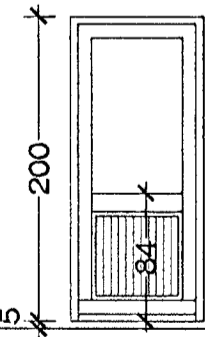

Svalahurð 1 stk.  
hjón

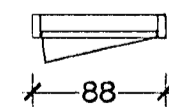
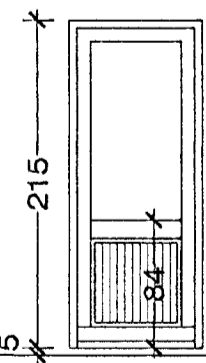

Hurð 1 stk.  
bilgeymsla

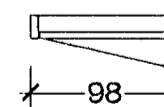
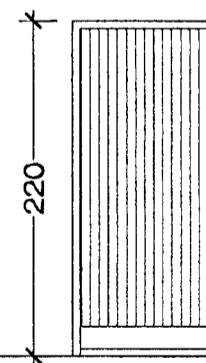

GLUGGAR OG HURÐIR M 1 : 50

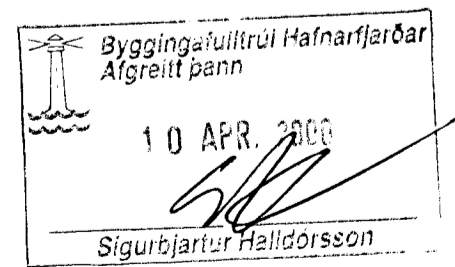

SPÓAÁS 10, HAFNARFIRÐI GLUGGAR, HURÐIR

VERK. NR. 223

TEIKN. NR. 204

DAGS. 22.02.2000

BREYTT.

MÁL. 1:50

JÓN GUÐMUNDSSON

ARKITEKT

VINNUSTOFA, SKÚLAGÖTU 63 REYKJAVÍK. Sími 552 5055

KT. 310651 3289