

GLUGGI G11  
3 STK.

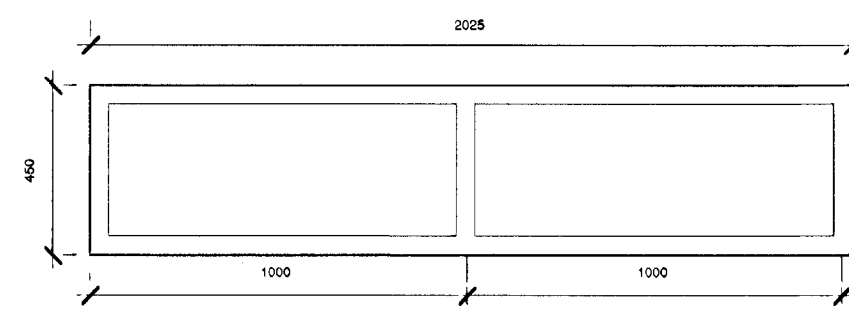

GLUGGI G1  
ÍSTEYPTUR GLUGGI  
1 STK.

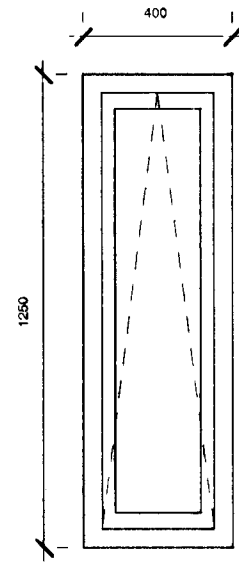
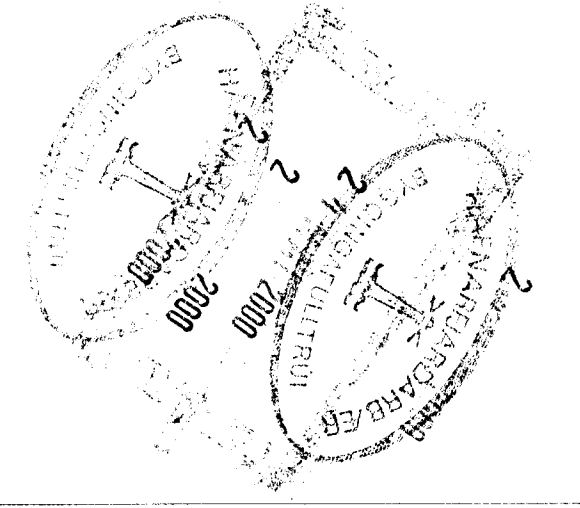

GLUGGI G5  
ÍSTEYPTUR GLUGGI  
1 STK.

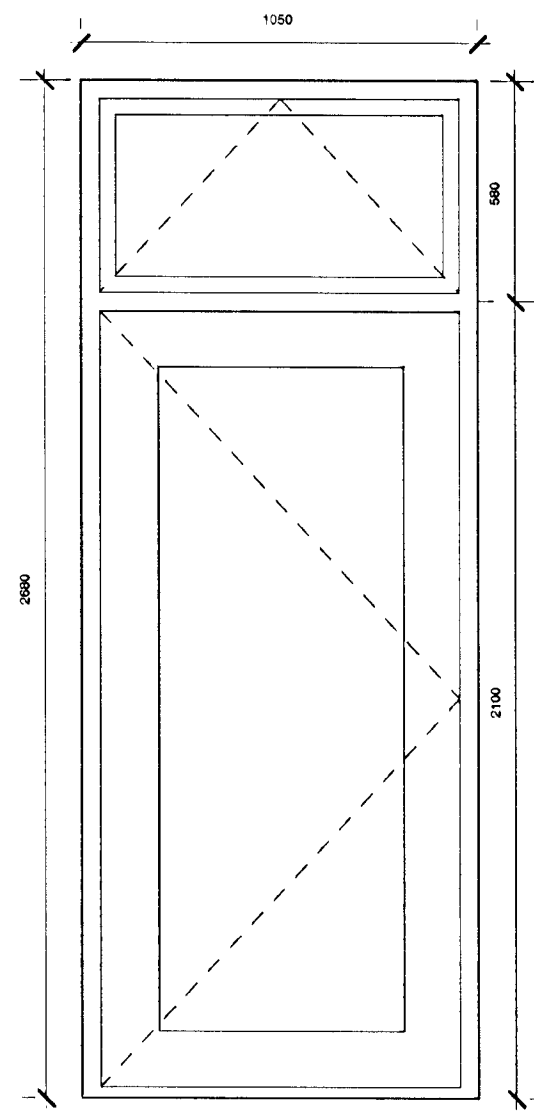

HURÐ/GLUGGI ÚH2  
ÍSTEYPTUR KARMUR/GLUGGI  
1 STK.

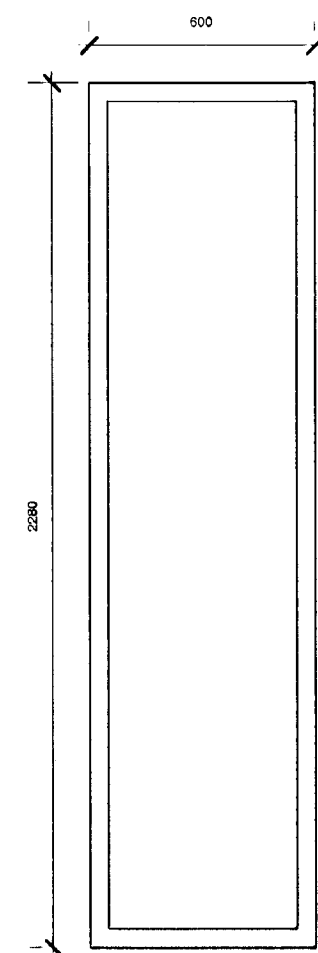

GLUGGI G7  
ÍSTEYPTUR GLUGGI  
1 STK.

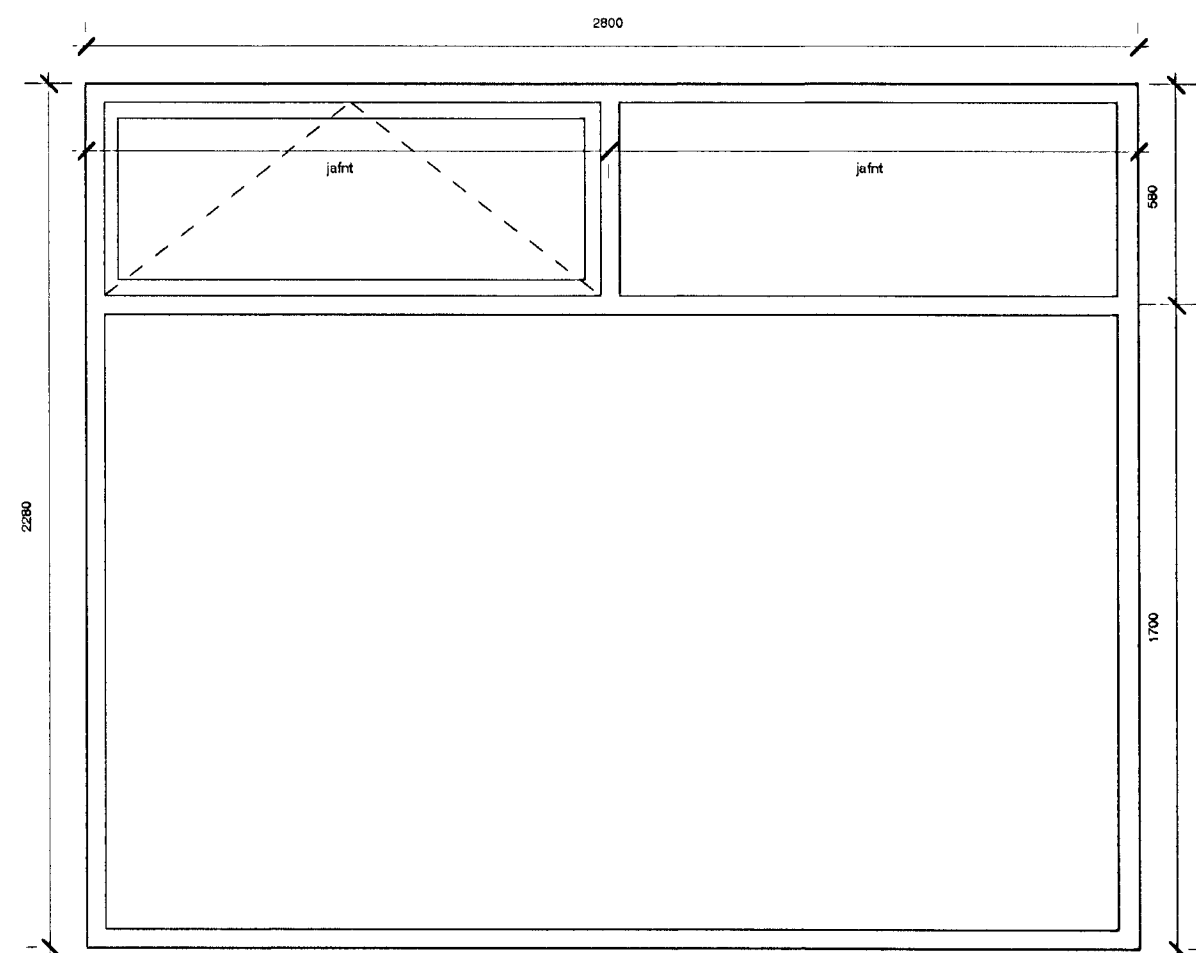

GLUGGI G8  
ÍSTEYPTUR GLUGGI  
2 STK.

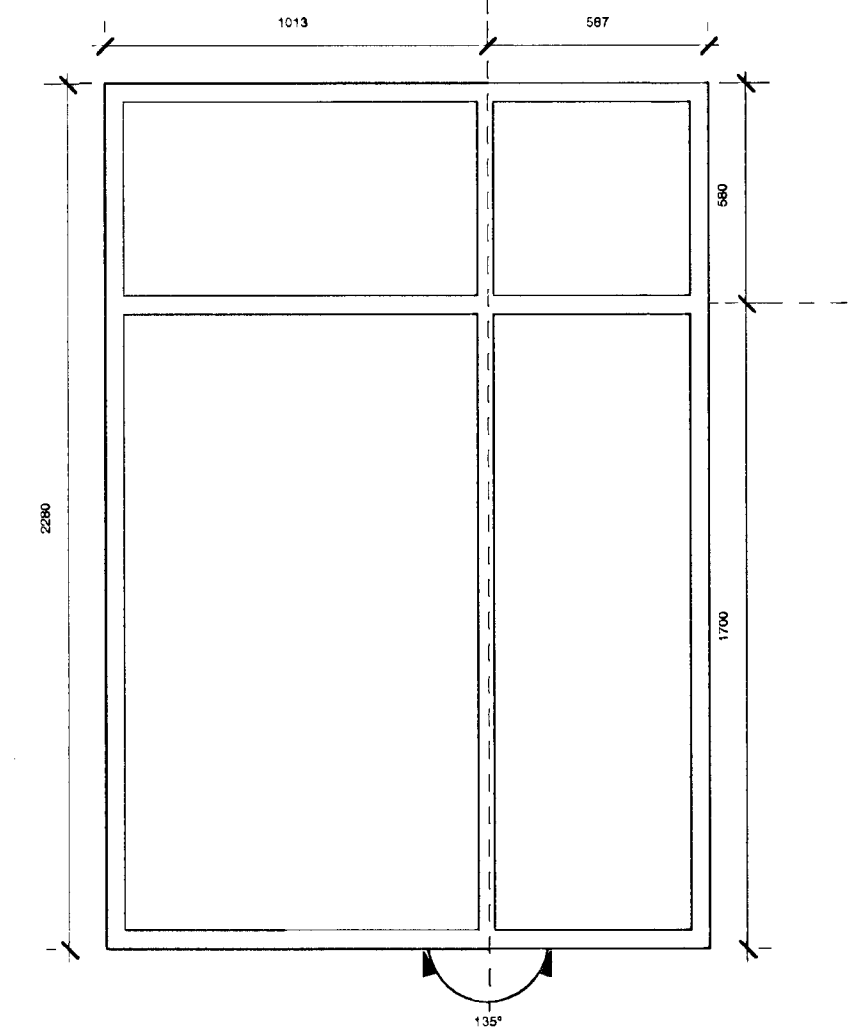

GLUGGI G9  
ÍSTEYPTUR GLUGGI  
1 STK.

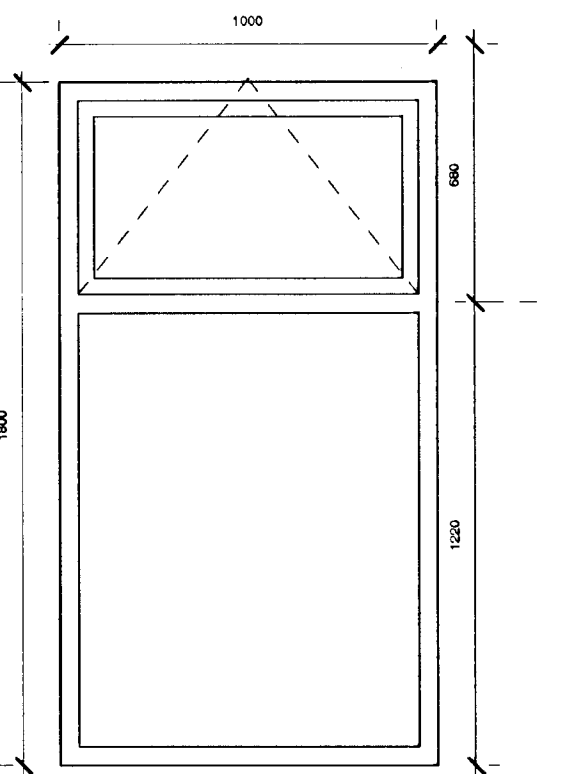
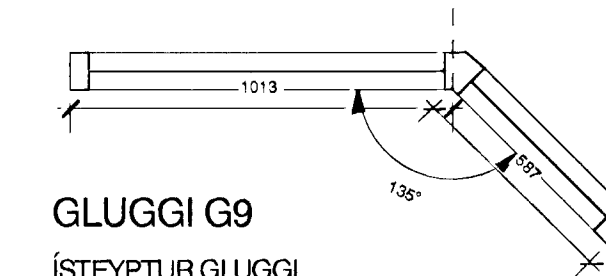

GLUGGI G10  
ÍSTEYPTUR GLUGGI  
1 STK.

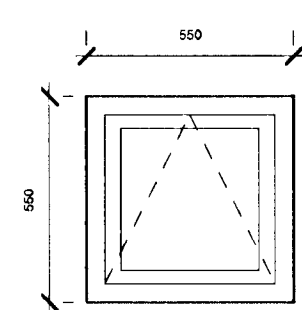

GLUGGI G1  
ÍSTEYPTUR GLUGGI/KARMUR  
1 STK.

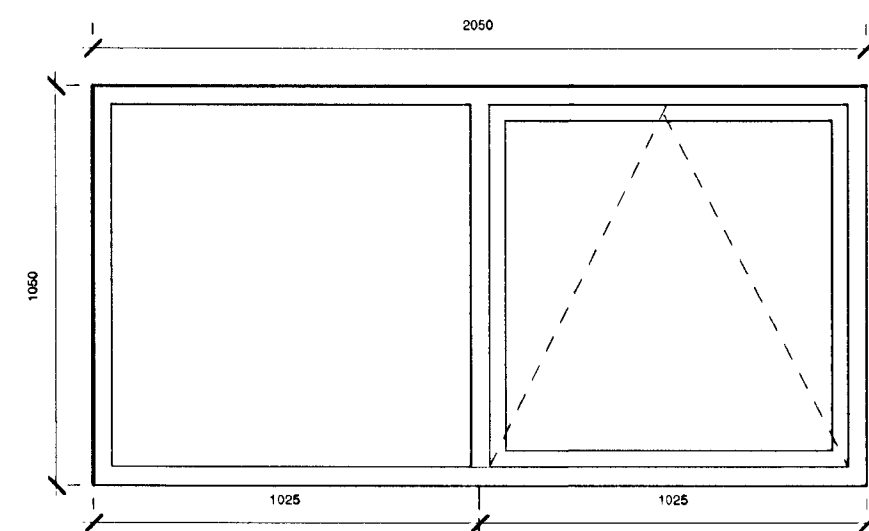

GLUGGI G2  
ÍSTEYPTUR GLUGGI/KARMUR  
3 STK.

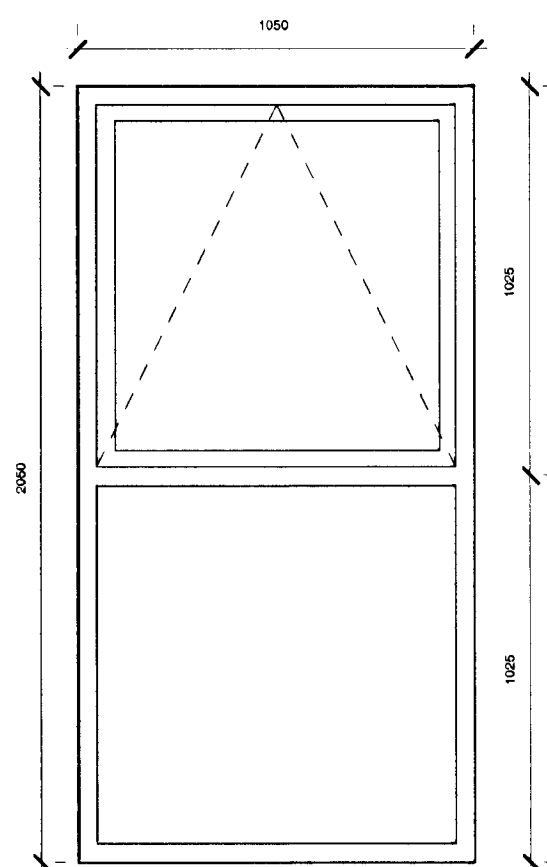

GLUGGI G3  
ÍSTEYPTUR GLUGGI/KARMUR  
1 STK.

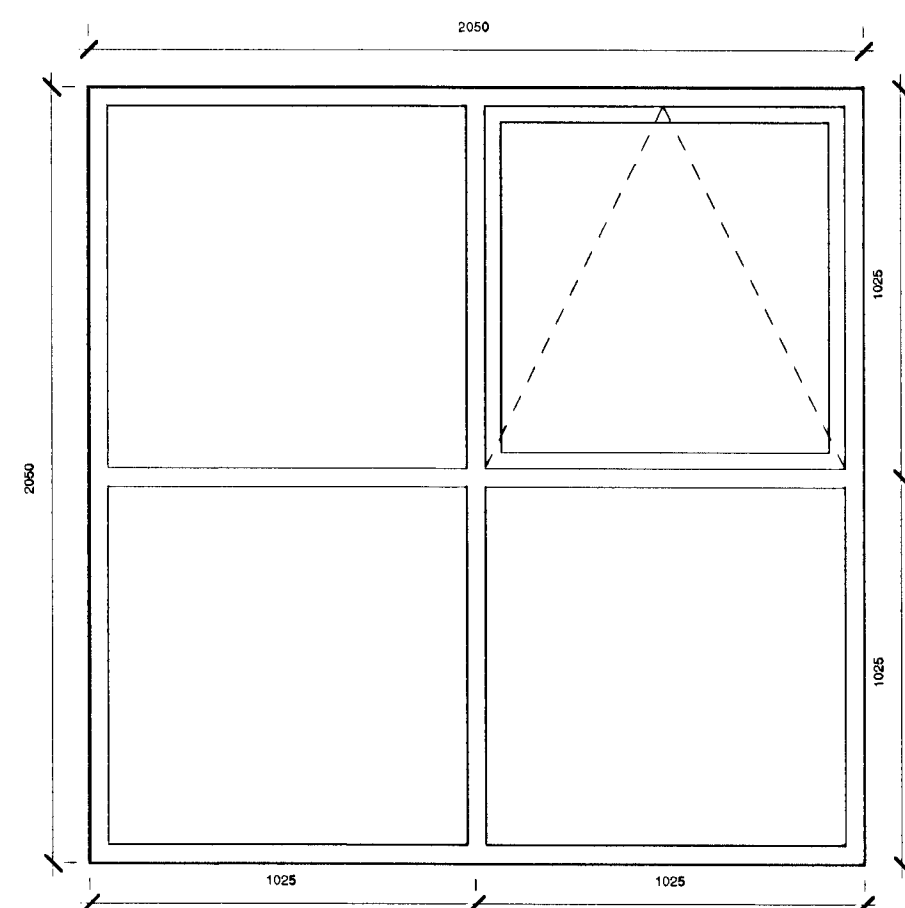

GLUGGI G4  
ÍSTEYPTUR GLUGGI/KARMUR  
1 STK.

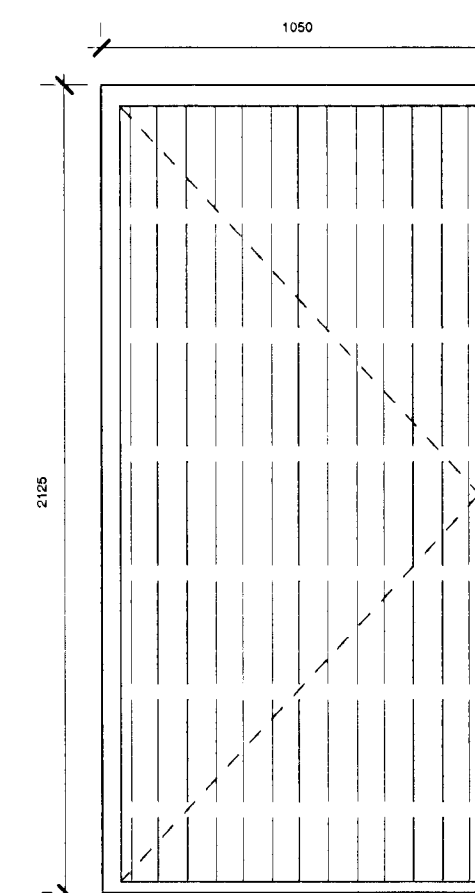

ÚH 4  
ÍSTEYPTUR KARMUR  
1 STK. HURÐ EKKI MEDTALIN

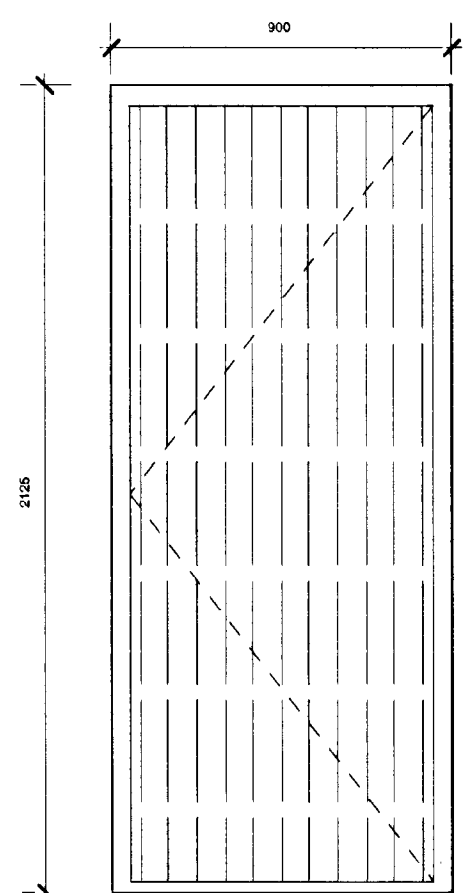

ÚH 5  
ÍSTEYPTUR KARMUR  
1 STK. HURÐ EKKI MEDTALIN

Byggingaáttir Hafnarjarðar  
Aljeit þann  
24 MAÍ 2000  
Ólafur Þ. Hersisson

Útg.	breytingar	dags

athugasemdir  
Sjá grunnmynd 201 sem sýnir gluggaúrnr, smíð, skilmyndir 204 & 205.  
Töknir 302 sýnir glugga og hurðir sem selja skulu. Í öðru uppdrögu.  
Pól glugga/hurðir eru ÚH, ÚH1, ÚH2 og ÚH3.  
Hurðir sem sýndar eru á þessum teikningu eru sýndar til viðspjónar og skil á framfarðum.

Verkefni:  
Einbýlishús að Spóvaási 18  
Hafnarfirði

Teiknað: Ó.Þ.H. Yfirfarið: Ó.Þ.H.  
Dags: 12.05.00 Mælikv.: 1:20

Heiti teikningar: TEIKN. NR.: 301  
ÍSTEYPTIR GLUGGAR  
Ólafur Þ. Hersisson  
ÚTGÁFA: \*

langhólsvégar 165 104 reykjavík sími: 696 3641  
netfang: ofh@netnet.is