

**ATH.:
TEIKNINGAR ERU
EKKI
Í MÆLIKVARÐA
EN UPPGEFIN MÁL Í MM.**

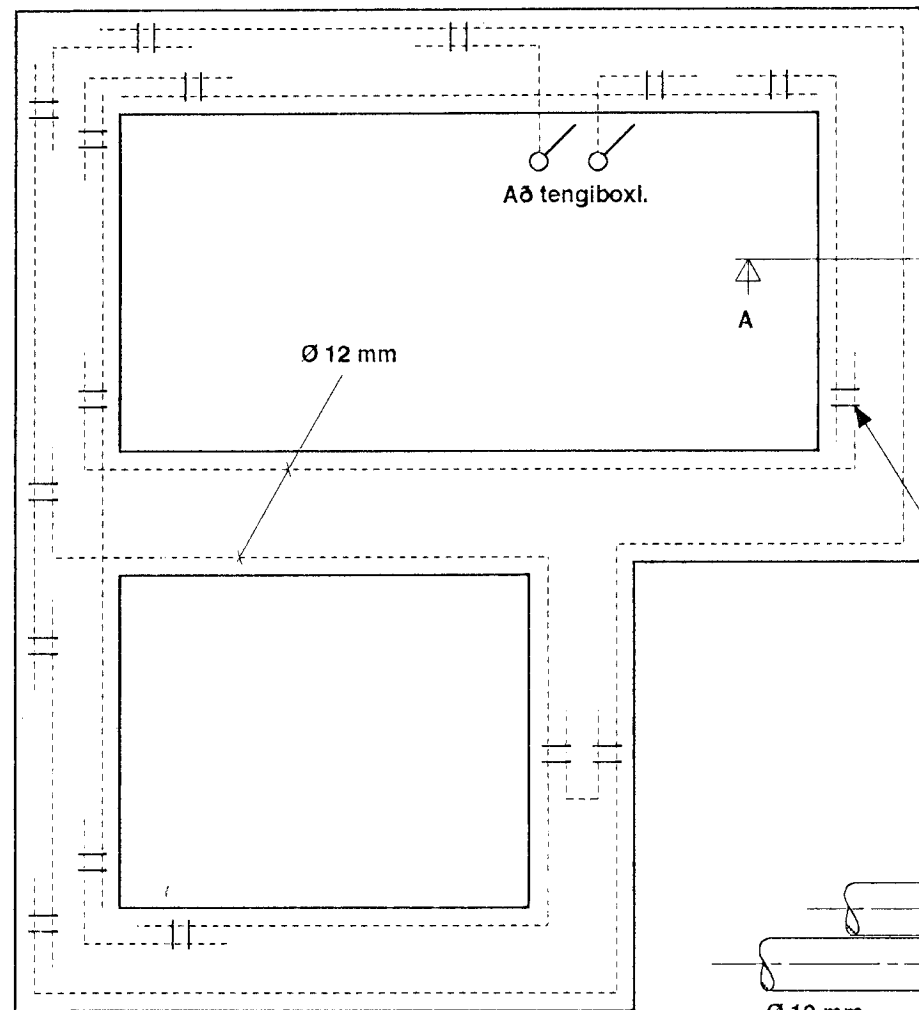

Almenn grunnmynd sökkulvegja.

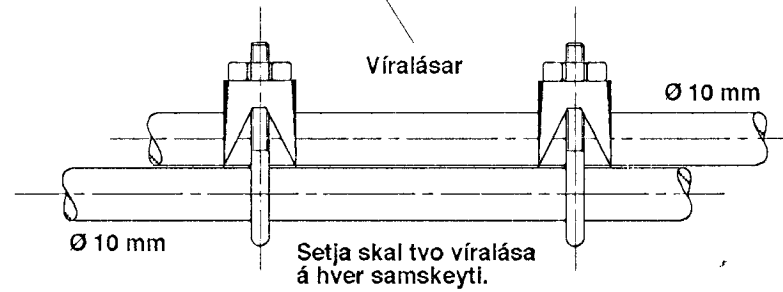

Sýnd eru tvö neðstu steypustyrktarjárnin í steypumóti ofan á neðstu mótavírum.

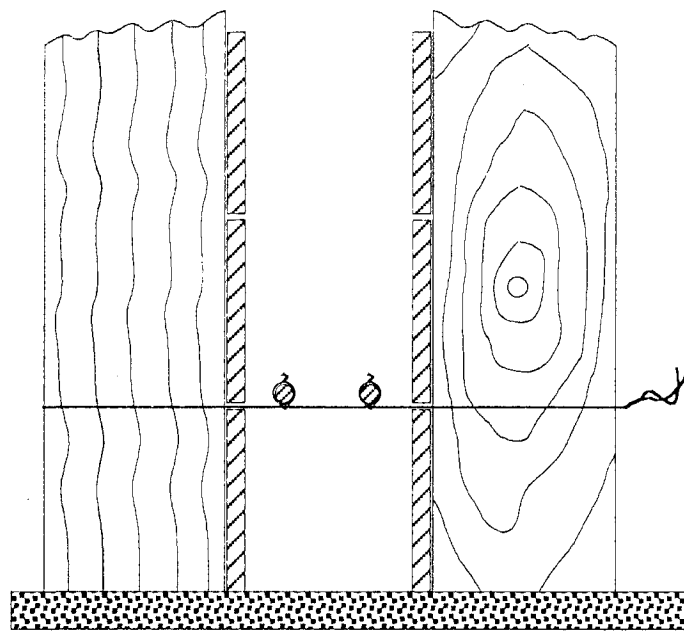

SNID A-A

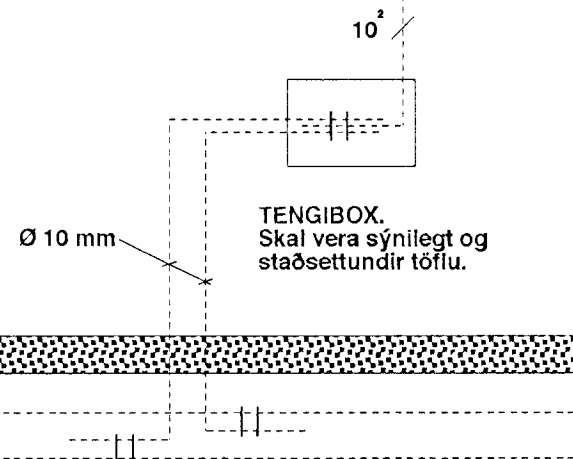
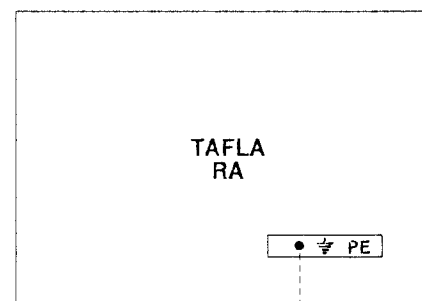

SNID Í TÖFLUVEGG

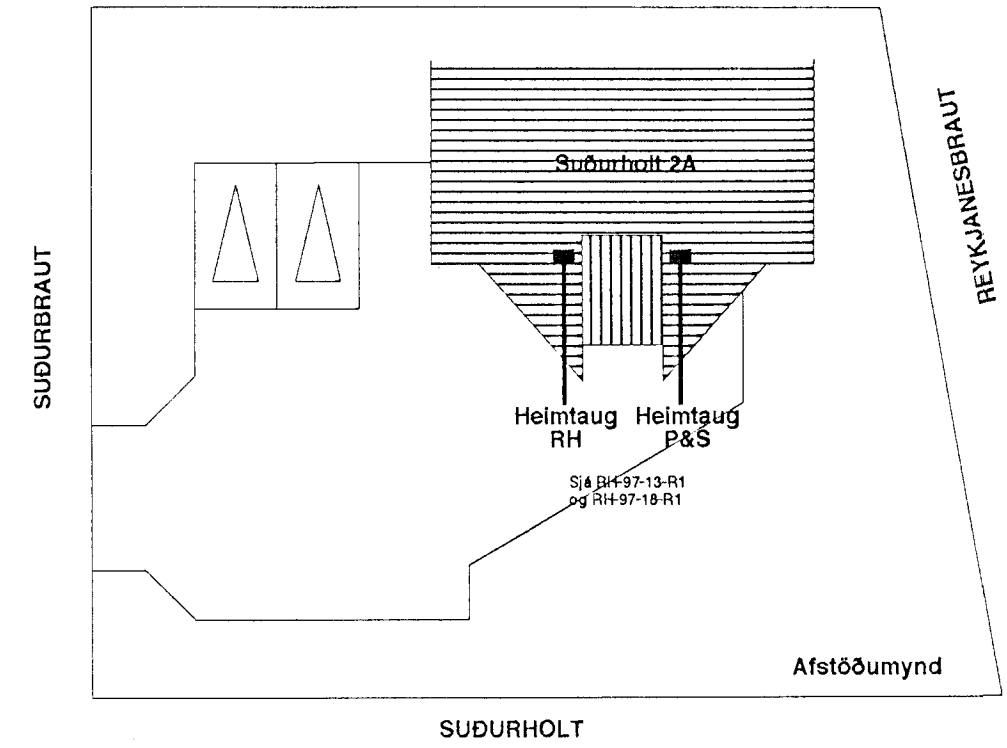

SUDURHOLT

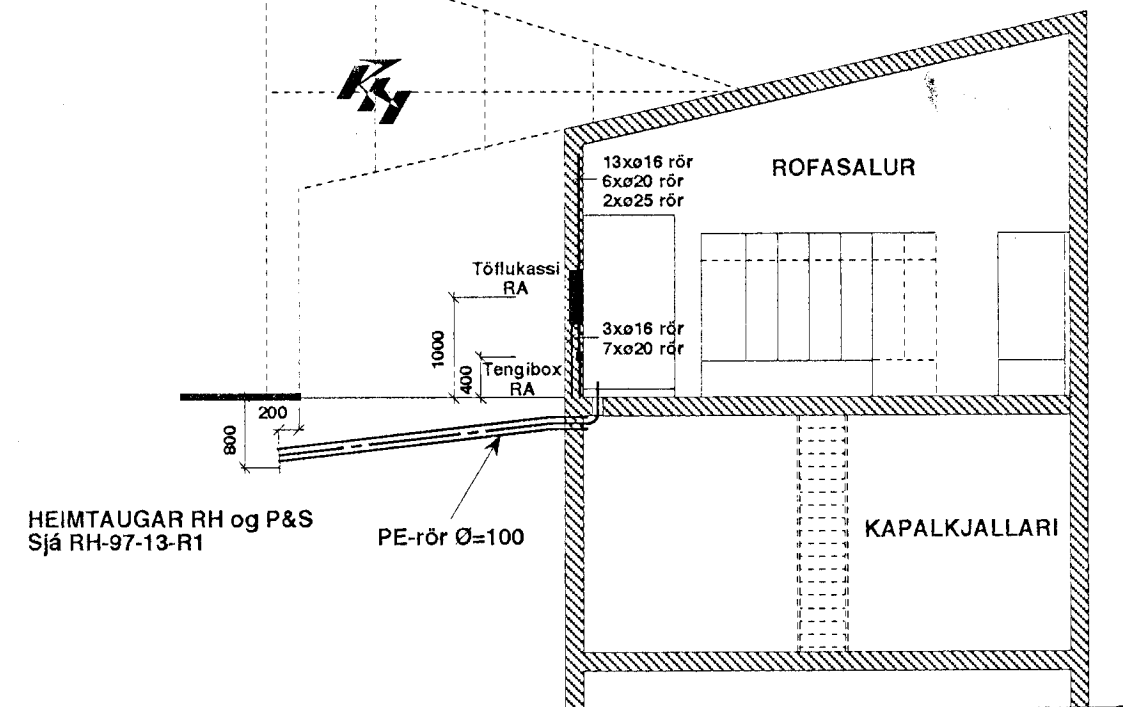

		ROFASTÖÐ Raflegnateikning Sökkulskaut-afstöðumynd, þversniðo.fl.	
		Daga: okt. '97 Háttmáð: wvs Teiknað: ldw/vvs Samþ.: Kvarði: 120	
Teikn. nr.: RH-97-20-R1	Hetti:		