

Samþykkt þann
08 MARS 1999
Byggingafulltrúinn í Hafnarfirði
F.h. Kristján Þórarinnsson

RP

EFNISLÝSING:

GLUGGAR ERU SMÍÐADIR ÚR FURU, VÖNDUÐU GÆÐAÆFNI
SAMKV. REGLUM ÞAR UM.
OPNANLEG FÖG ERU ÚR OREGONPINE, TOPPHENGÐ
OG OPNAST ÚT.
ATH. OPNANLEGT FAG YFIR ADALDYRUM.

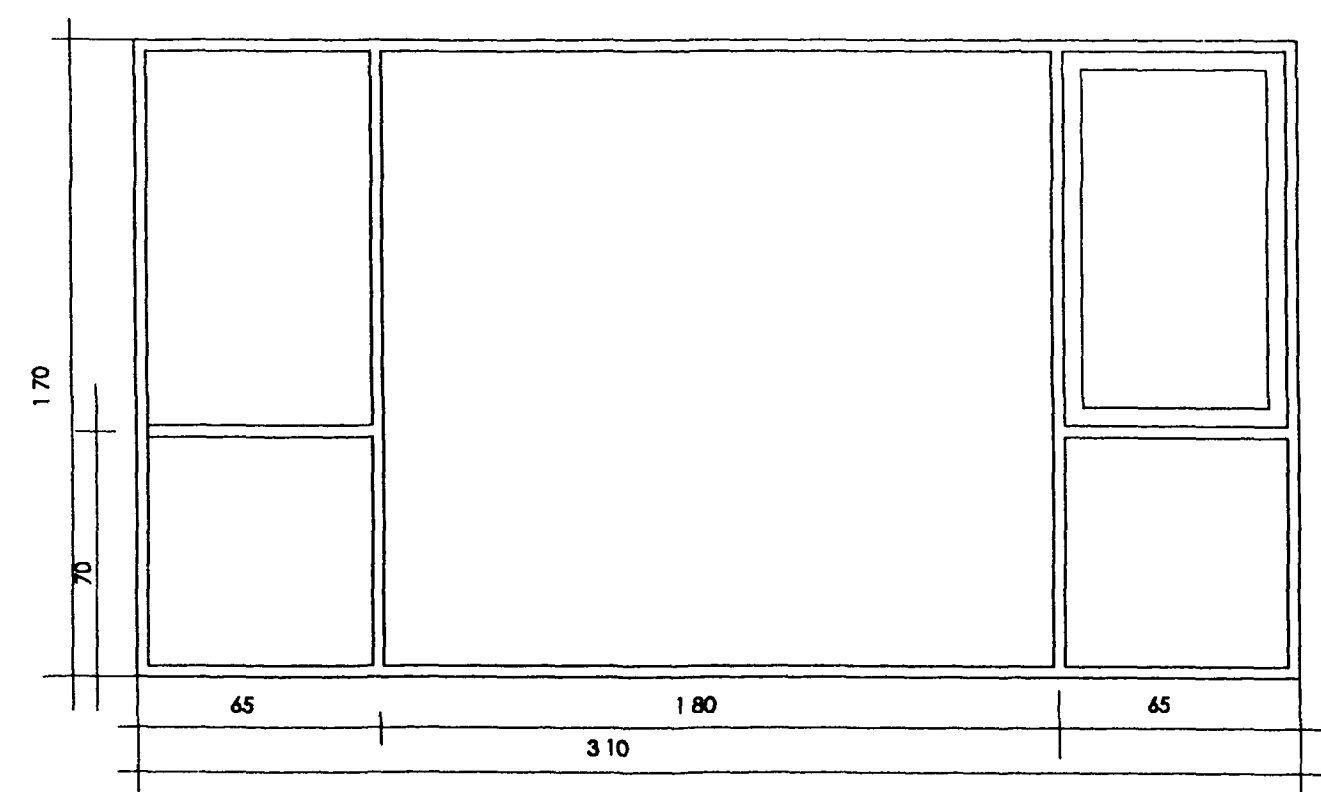

GLUGGI # 1. 1 STK.

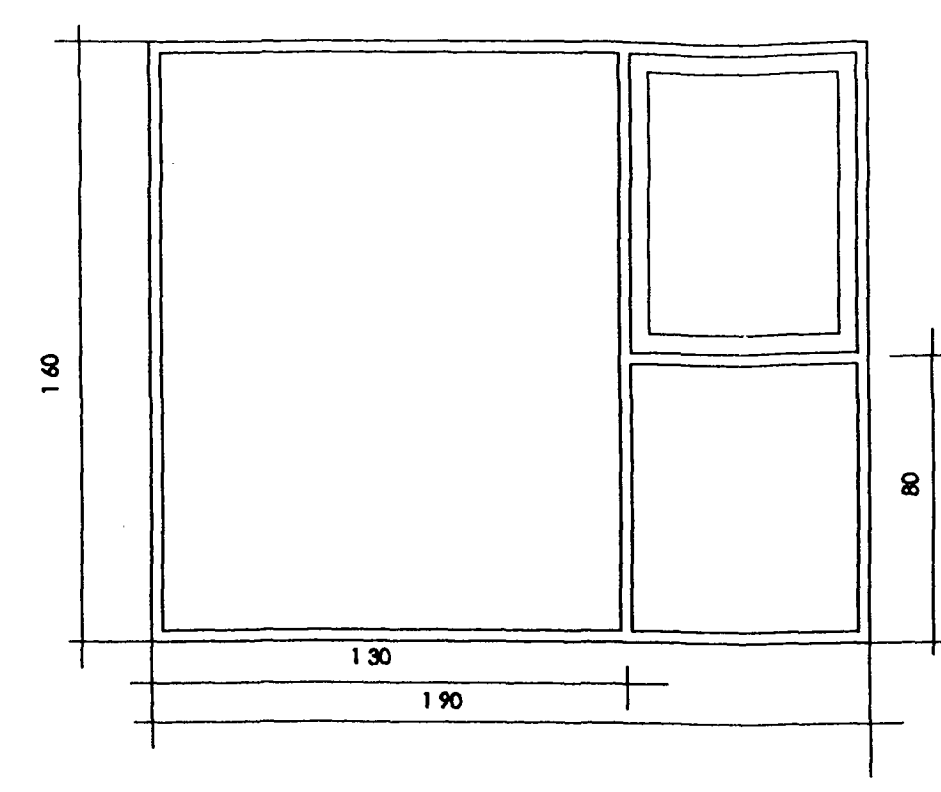

GLUGGI # 3. 1 STK.

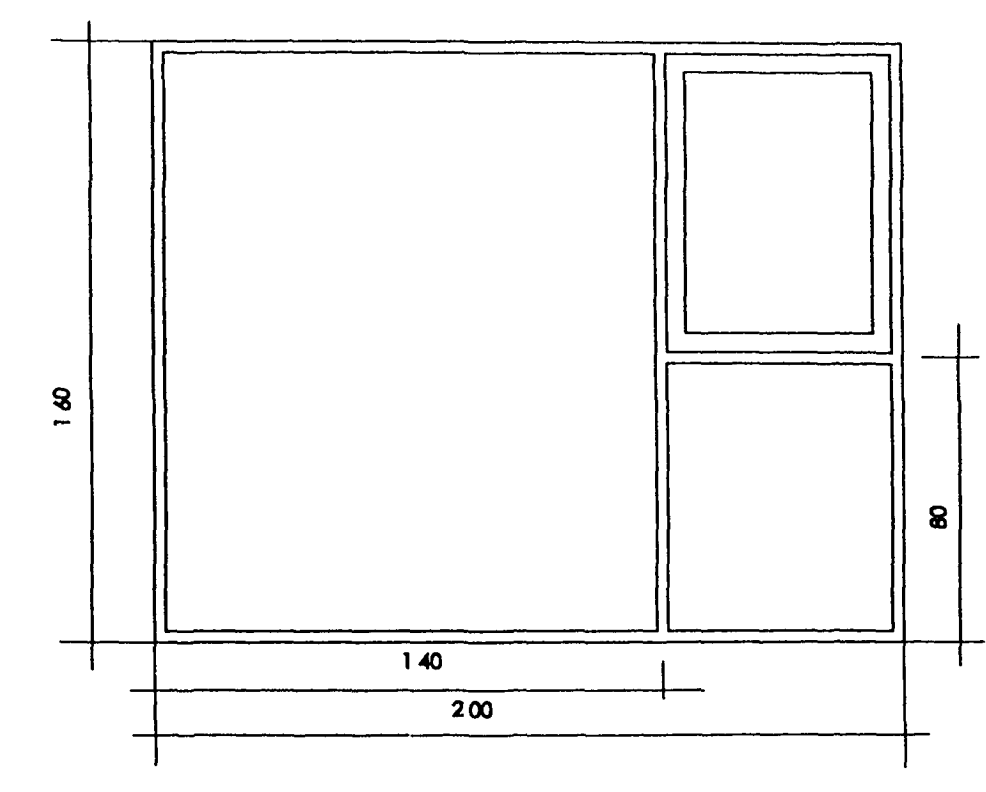

GLUGGI # 4. 1 STK.

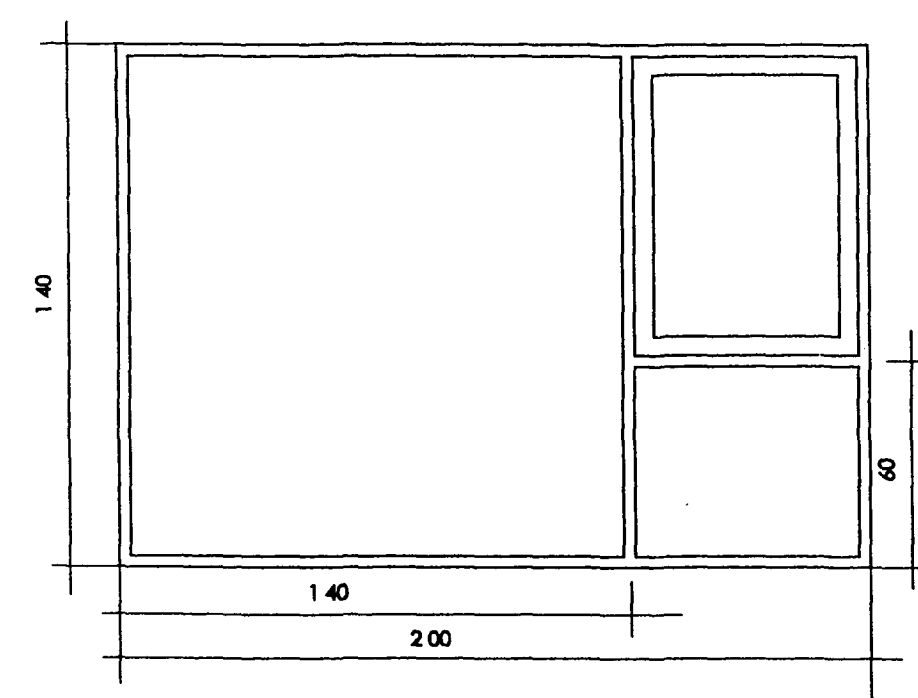

GLUGGI # 7. 1 STK.

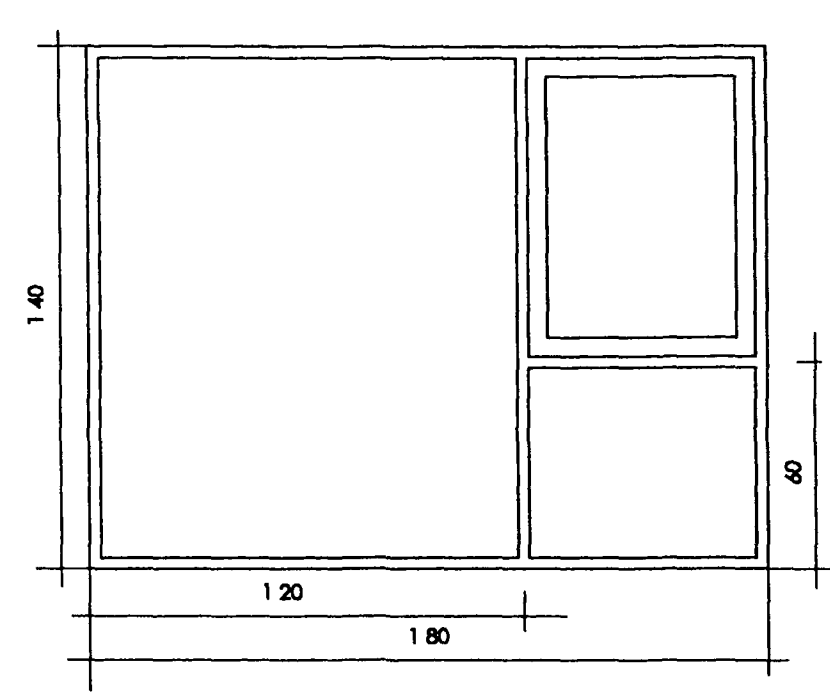

GLUGGI # 6. 2 STK.

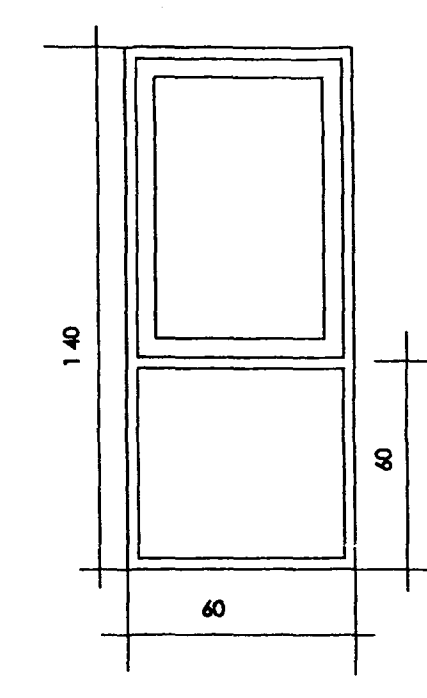

GLUGGI # 8. 1 STK.

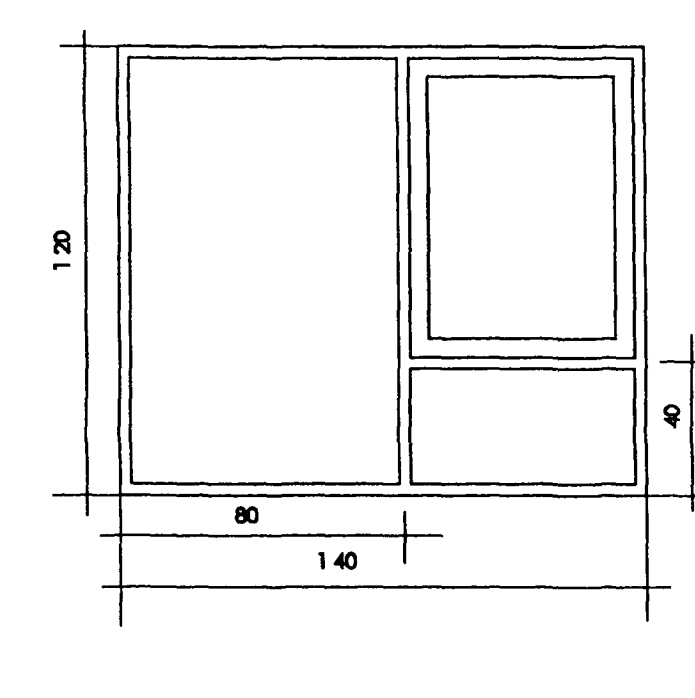

GLUGGI # 5. 2 STK.

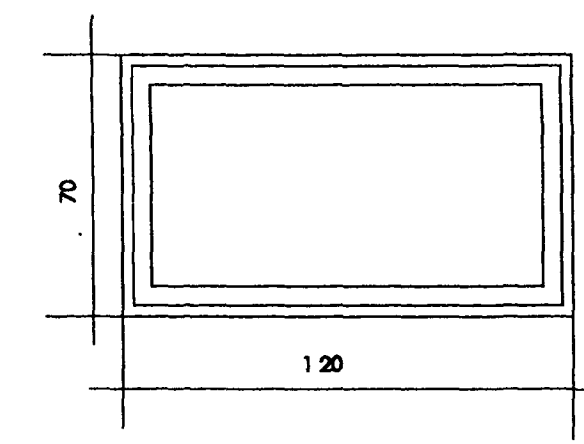

GLUGGI # 9. 2 STK.

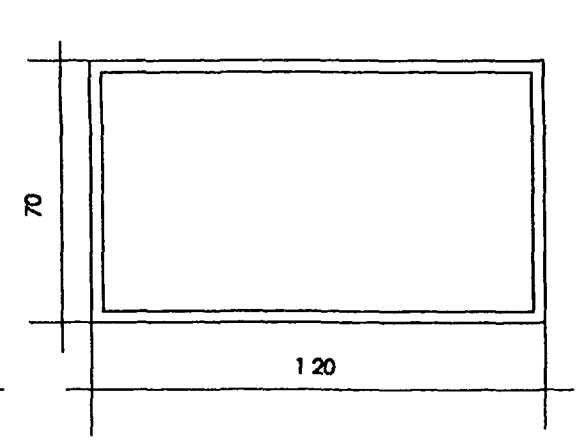

GLUGGI # 10. 1 STK.

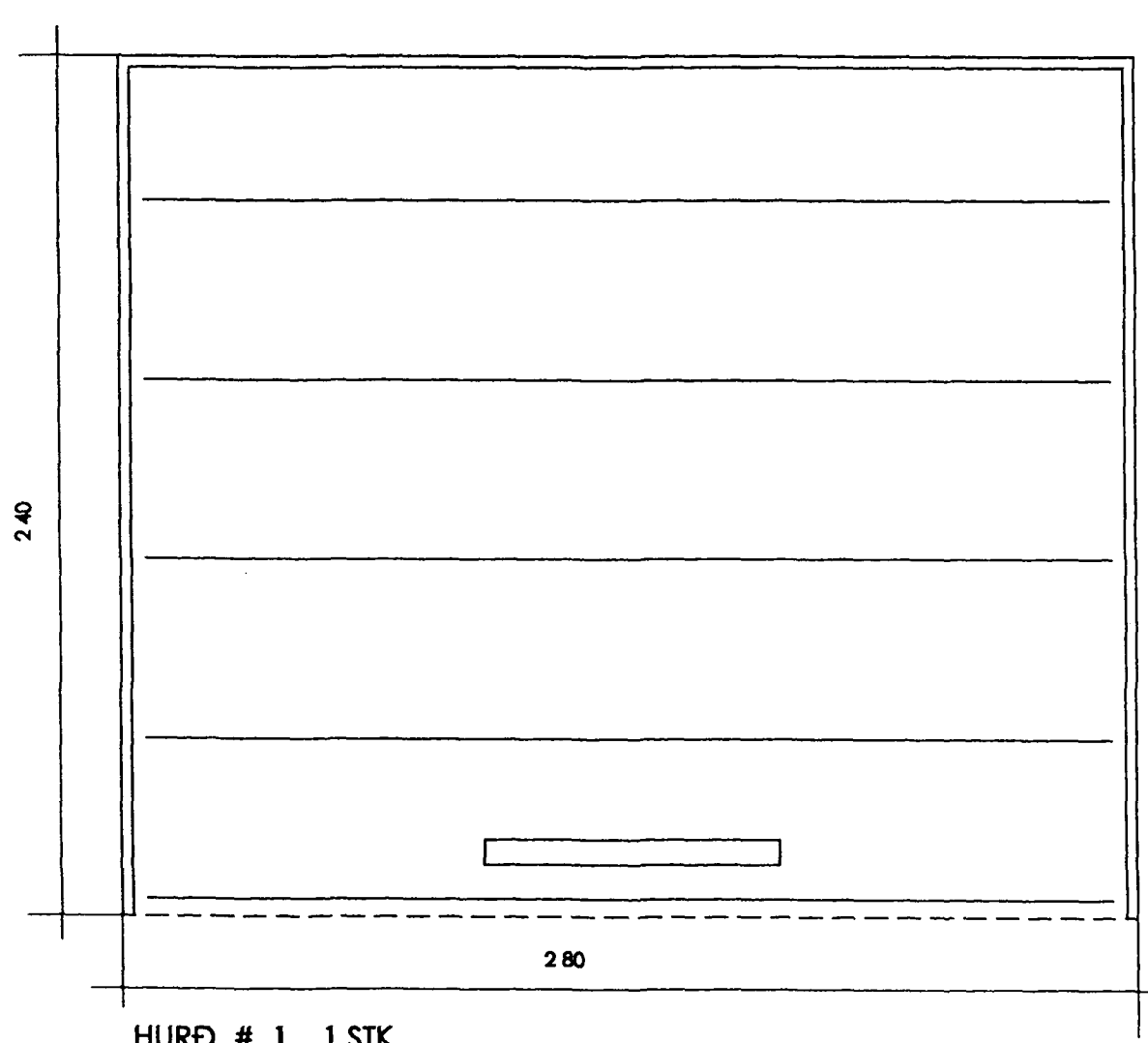

HURÐ # 1 1 STK.

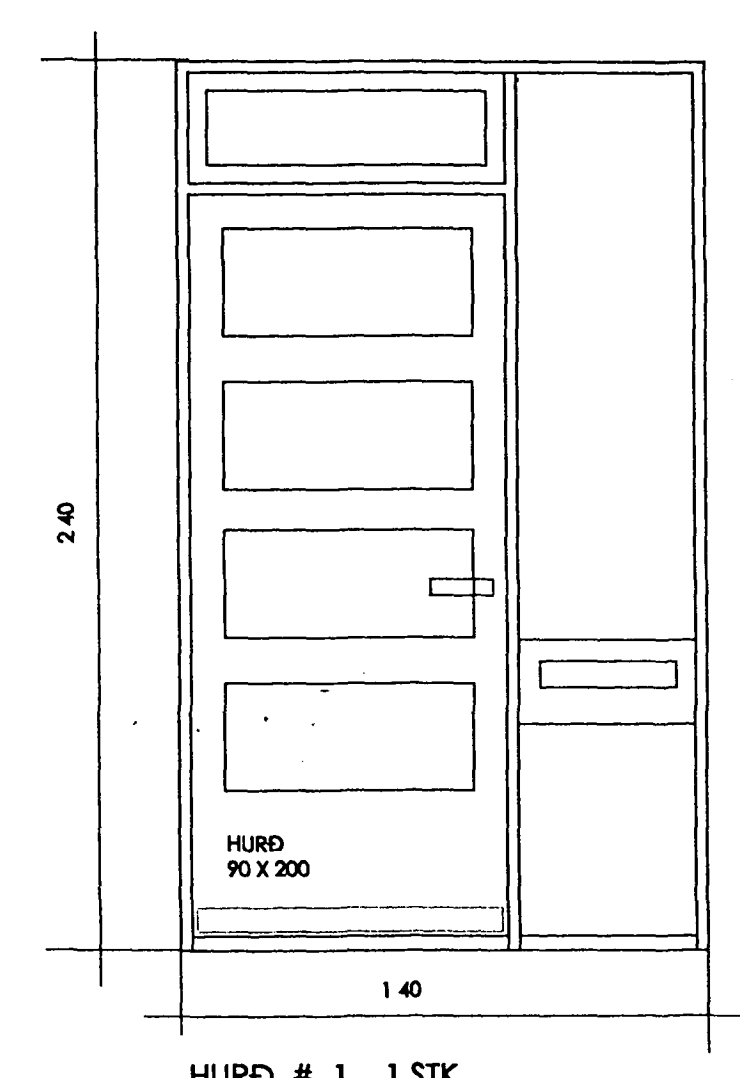

HURÐ # 1 1 STK.
HÆGRI HURÐ, OPNAST INN

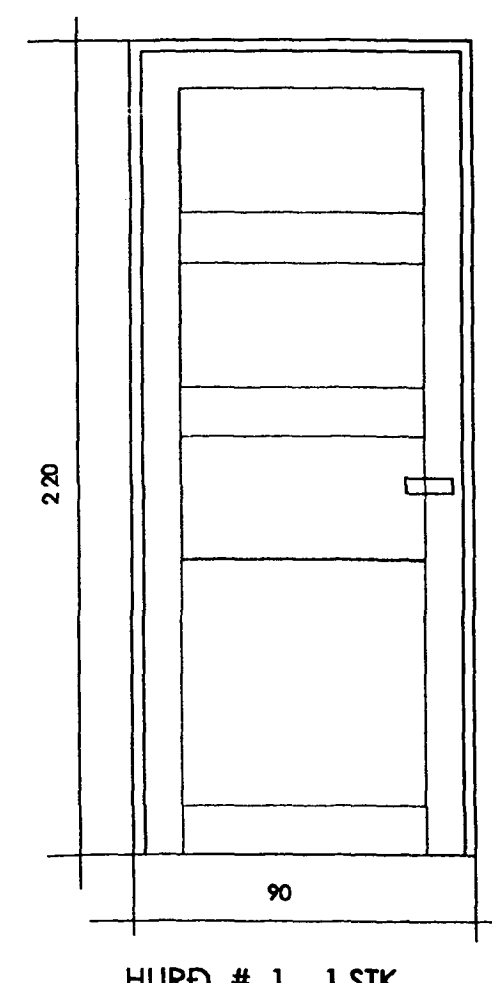

HURÐ # 1 1 STK.
VINSTRI HURÐ, OPNAST ÚT

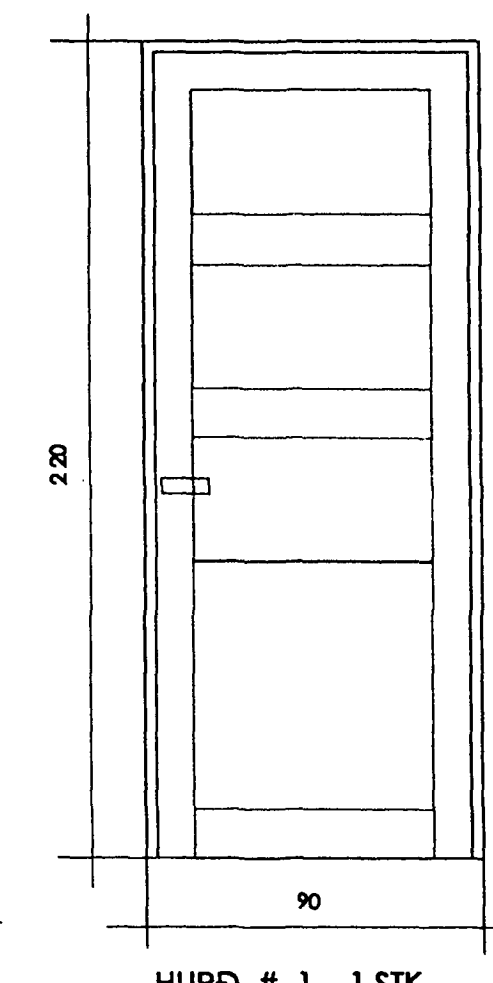

HURÐ # 1 1 STK.
HÆGRI HURÐ, OPNAST ÚT

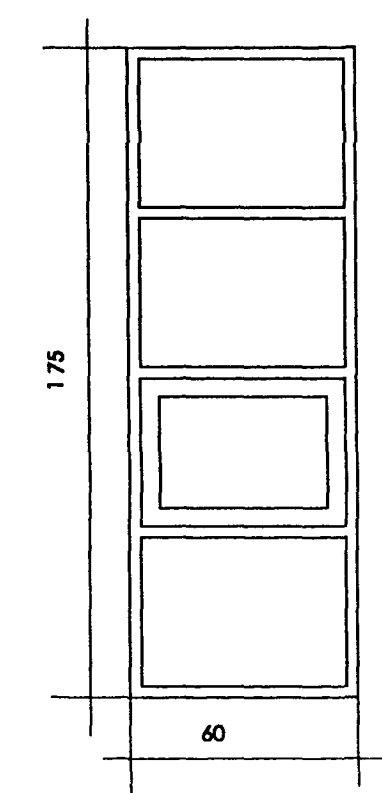

GLUGGI # 2. 1 STK.

GLUGGAR 13 STK, ALLS

HURÐIR 3 STK,
BÍG.HURÐ 1 STK.

TEIGABYGGÐ NR. 6 HAFNARFIRÐI

24.176.4

ÞRAG. 12.02.1999

HTEIGAB6

GLUGGAR OG HURÐIR

ÞAGS- NÓV.-1998

MKV. 1 : 20

ARTIK TEIKNISTOFA, SM, 421-4122 # GSM, 895-9202

STEINAR GEIRDAL BYGGINGARFRÆÐINGUR B.F.I.
040138 3829 DRANGAVELLIR NR. 2, 230 KEFLAVÍK