

Samþykkt á fundi bygginga-  
nefndar þ. 23. 6 1976  
BYGGINGAFULLTRÚI N  
Í HAFNARFIRDI  
*[Signature]*

FYRIR BREYTINGU

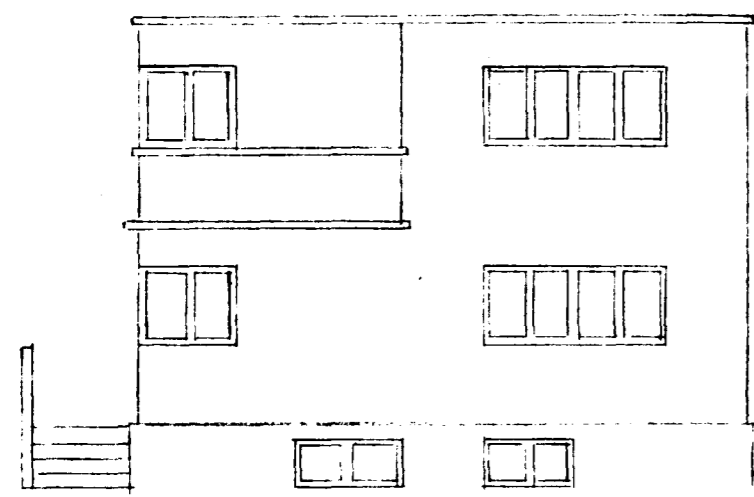

GÖTUHLIÐ

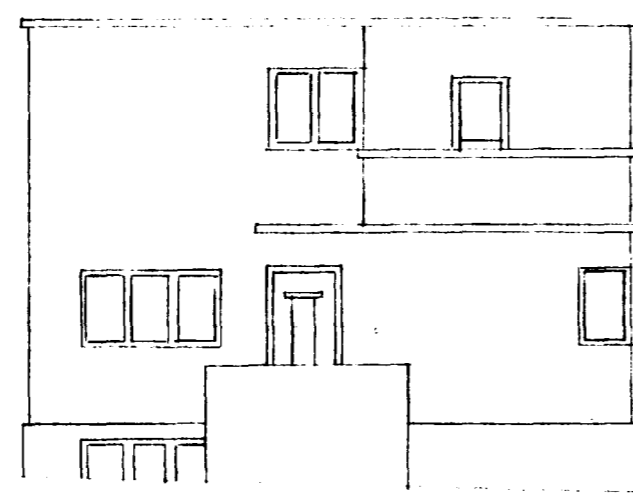

VESTURHLIÐ

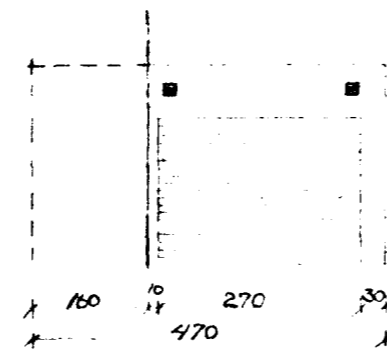

GÖTUHLIÐ

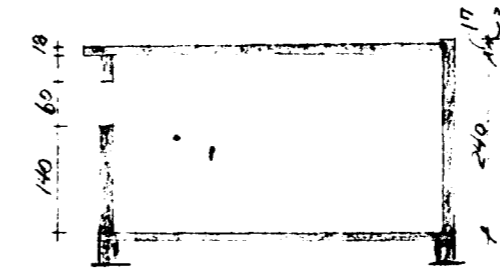

SNID A-A

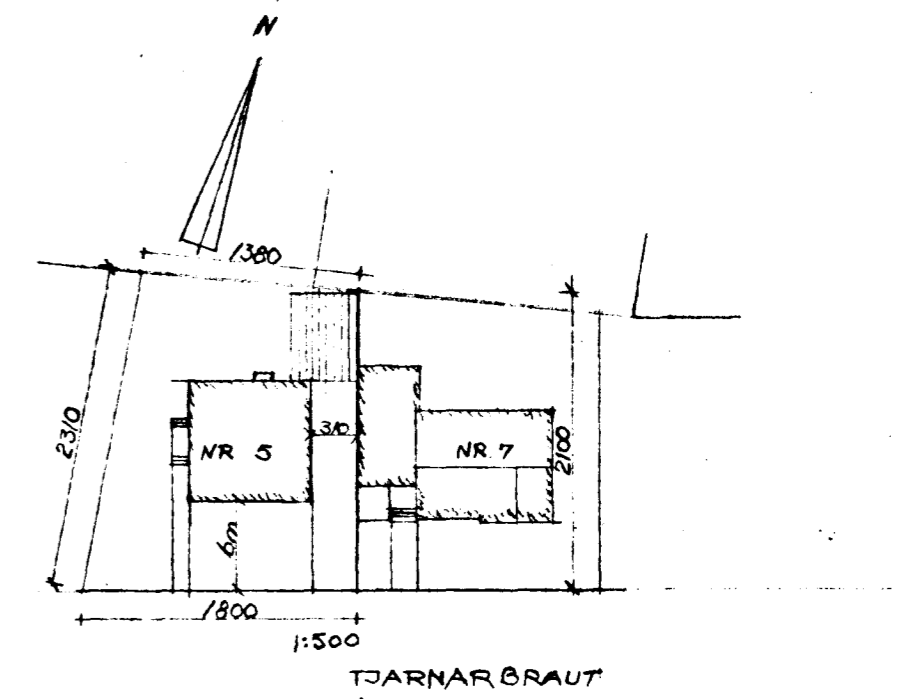

TJARNARBRAUT

tifftopdf - www.rubissoftware.com - Demo Version

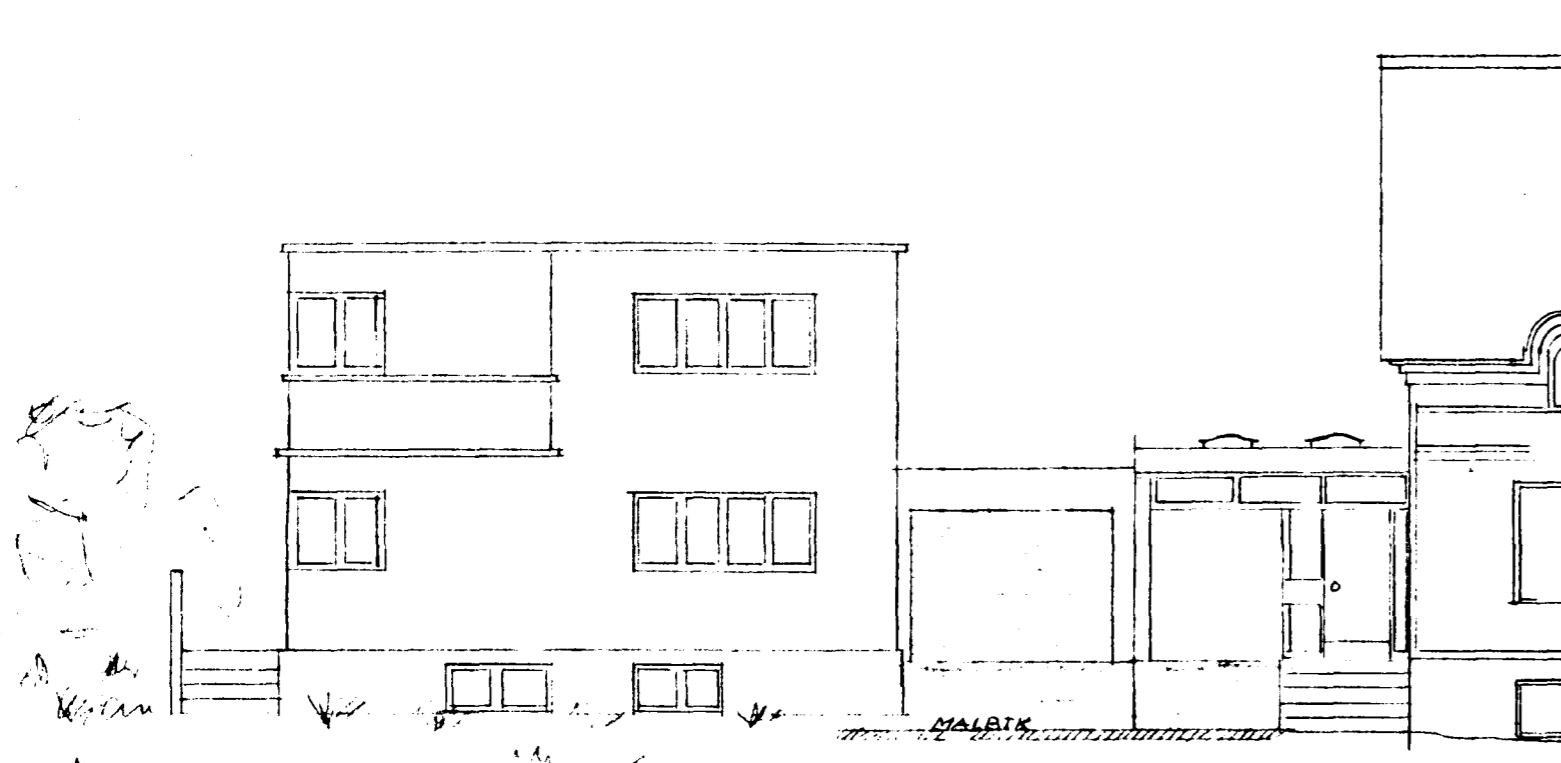

GÖTUHLIÐ EFTIR BREYTINGU

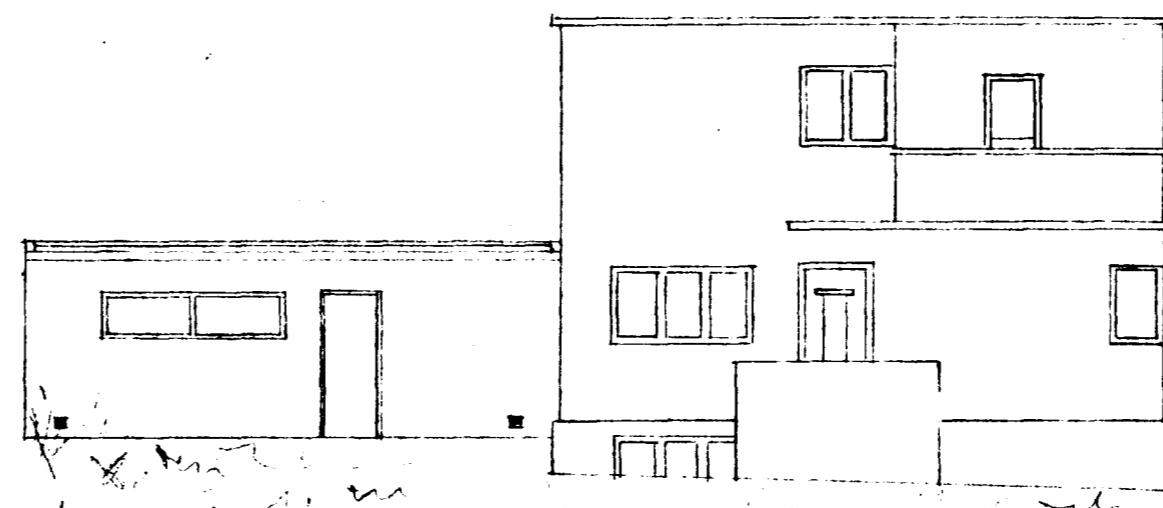

VESTURHLIÐ EFTIR BREYTINGU

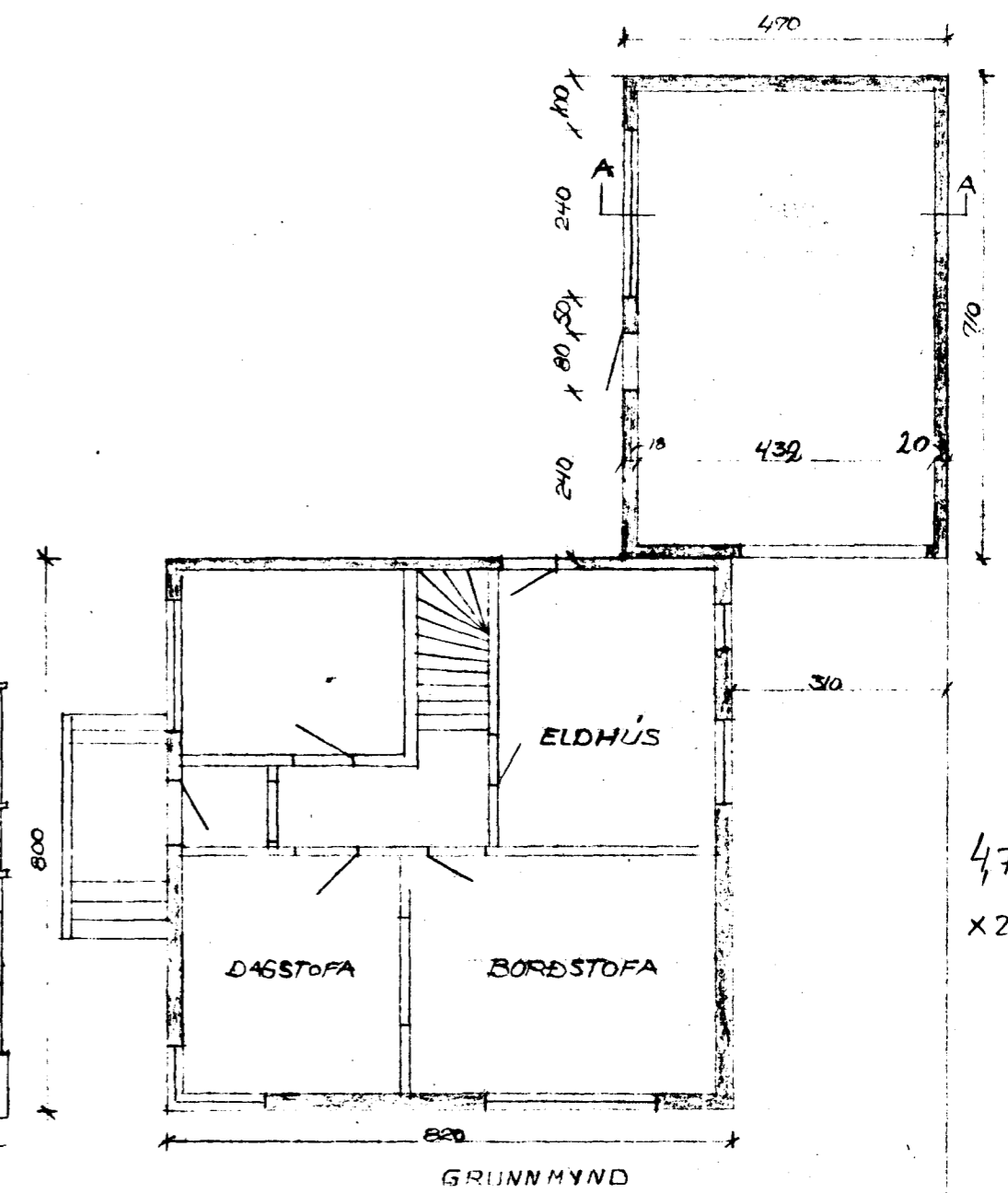

$47 \times 7,1 = 33,4 \text{ m}^2$   
 $\times 2,4 = 80,0 \text{ m}^2$

TEIKNING NR.	DAGS	NAFN	YFIRF
TJARNARBR. 5	Mælt: 21-6-76	F. Sig.	
	Hannað: 21-6-76	F. Sig.	
	Teiknað: 21-6-76	F. Sig.	
BILGEYMSLA			Mælikv 1:100 1:500
GRUNNMYND ÚTLIT SNID			Samb.