

Einangra skal alla stálbita með steinull og klæða af með eldtefjandi spónaplötum

Klæða skal stálbita með eldvörðum spónaplötum samkvæmt sniði H

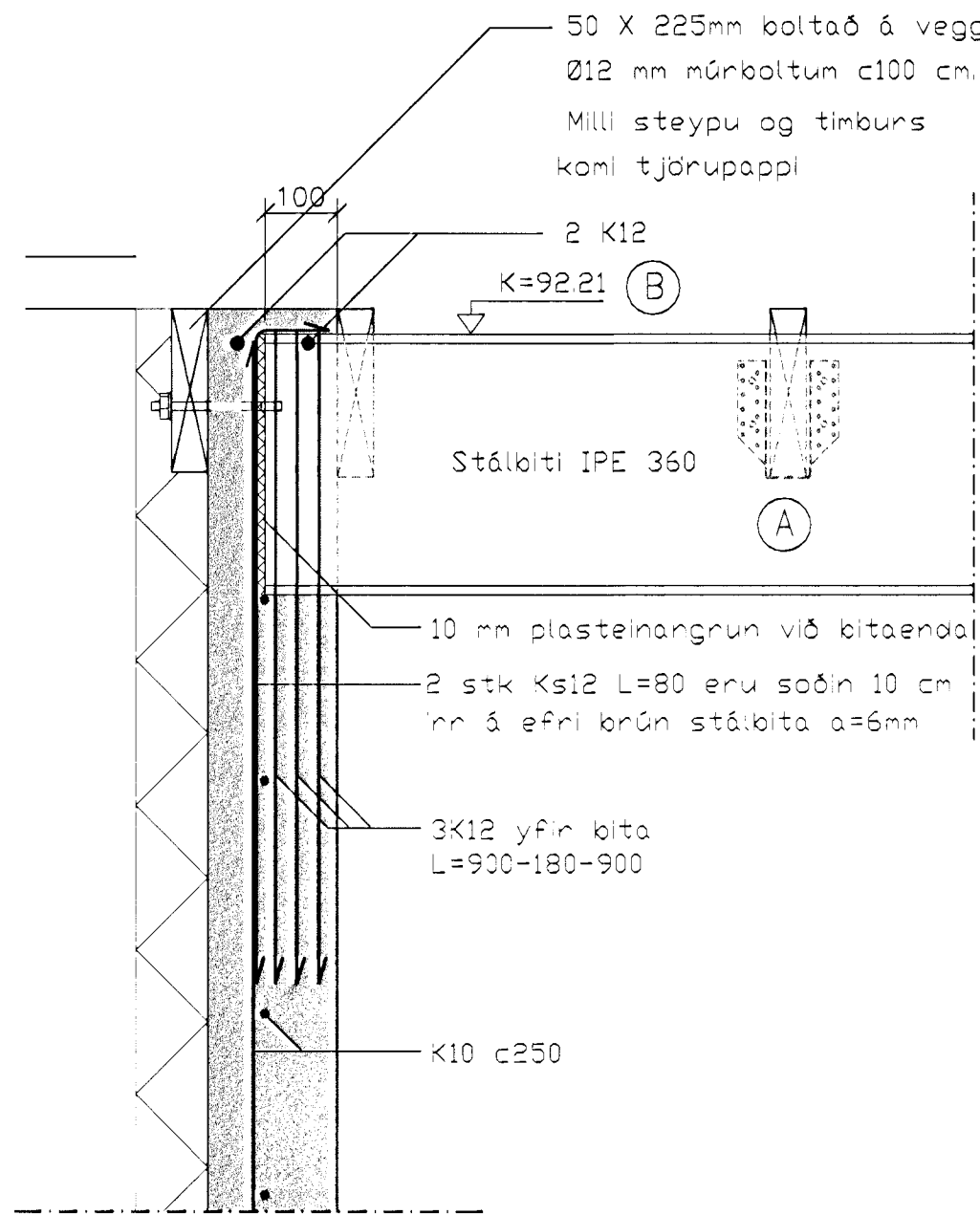

8 Deili 8
8 7 Mkv. 1:10

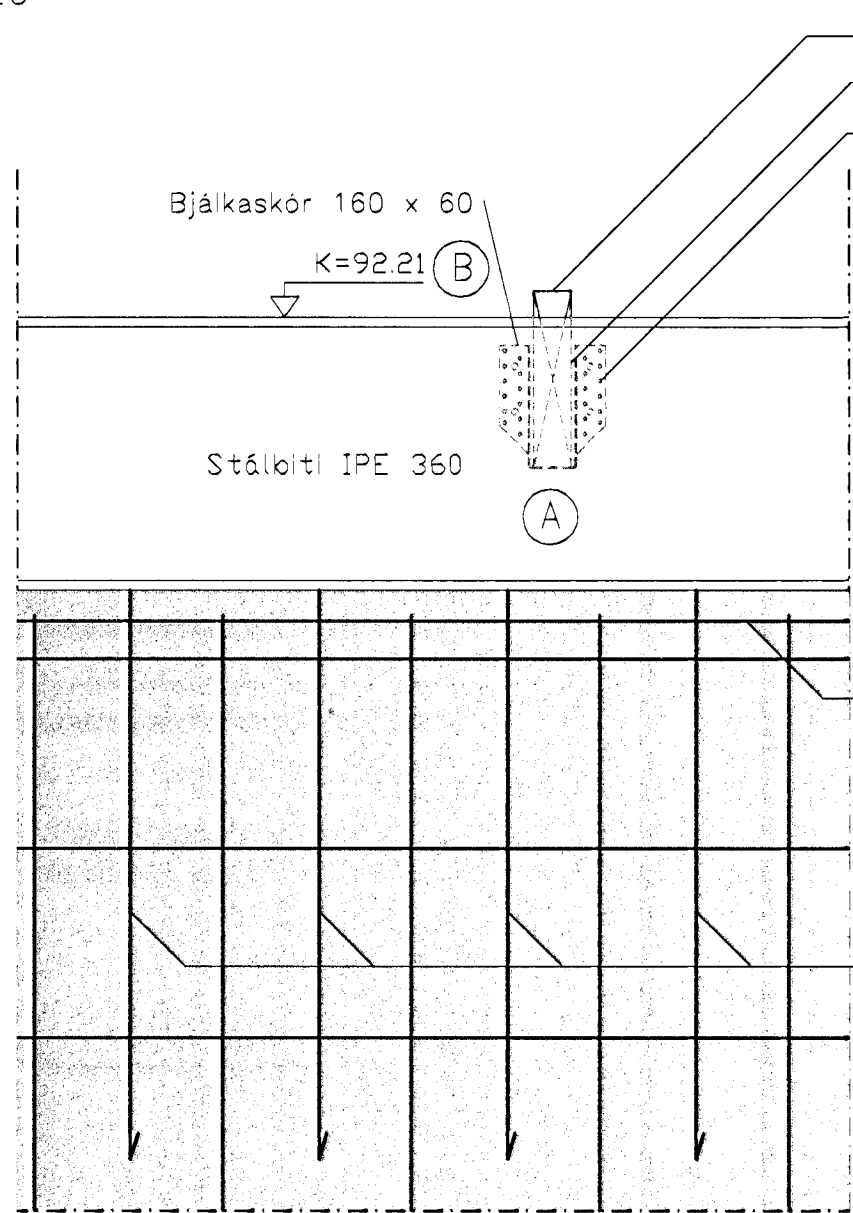

9 Deili 9
8 7 Mkv. 1:10

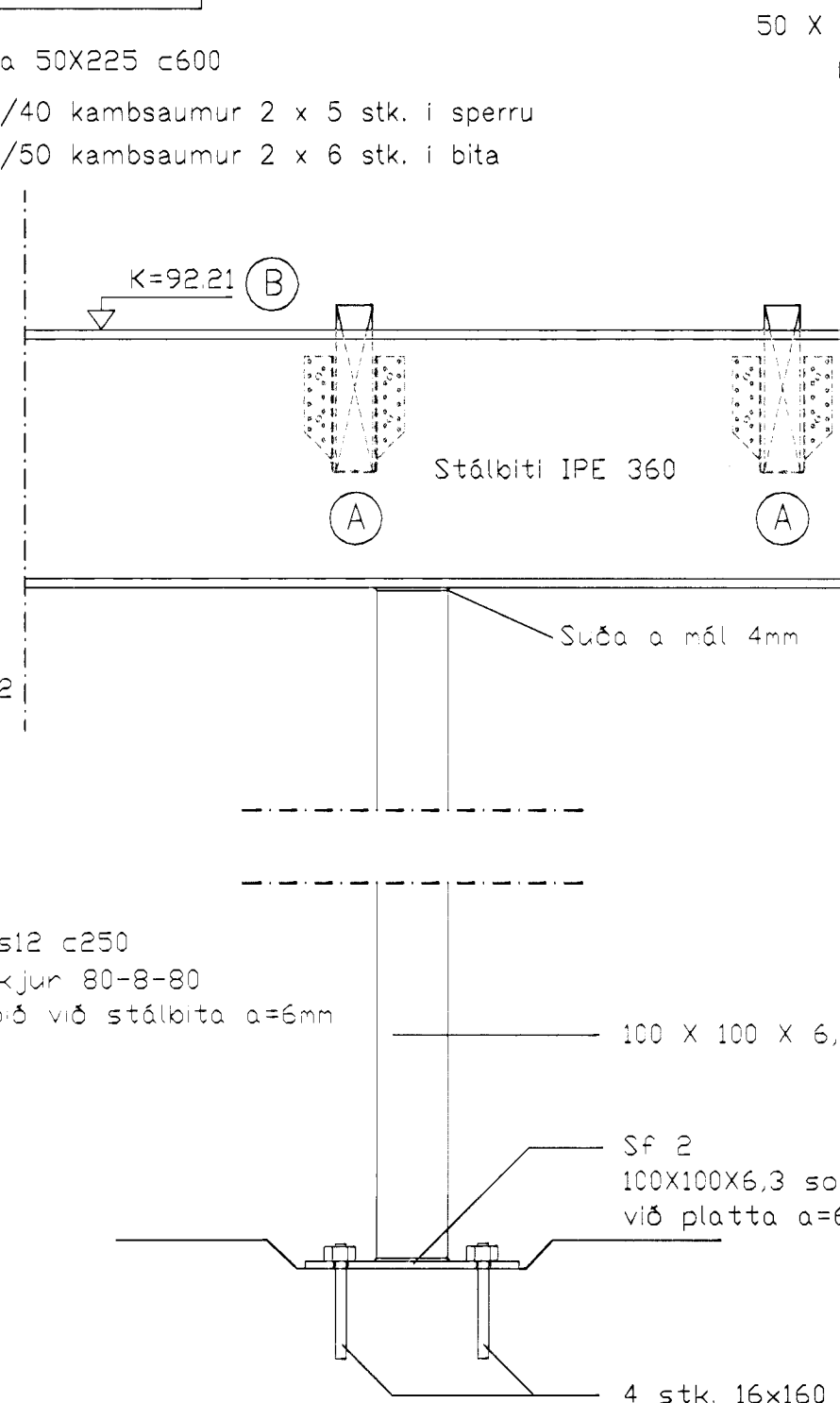

10 Deili 10
8 7 Mkv. 1:10

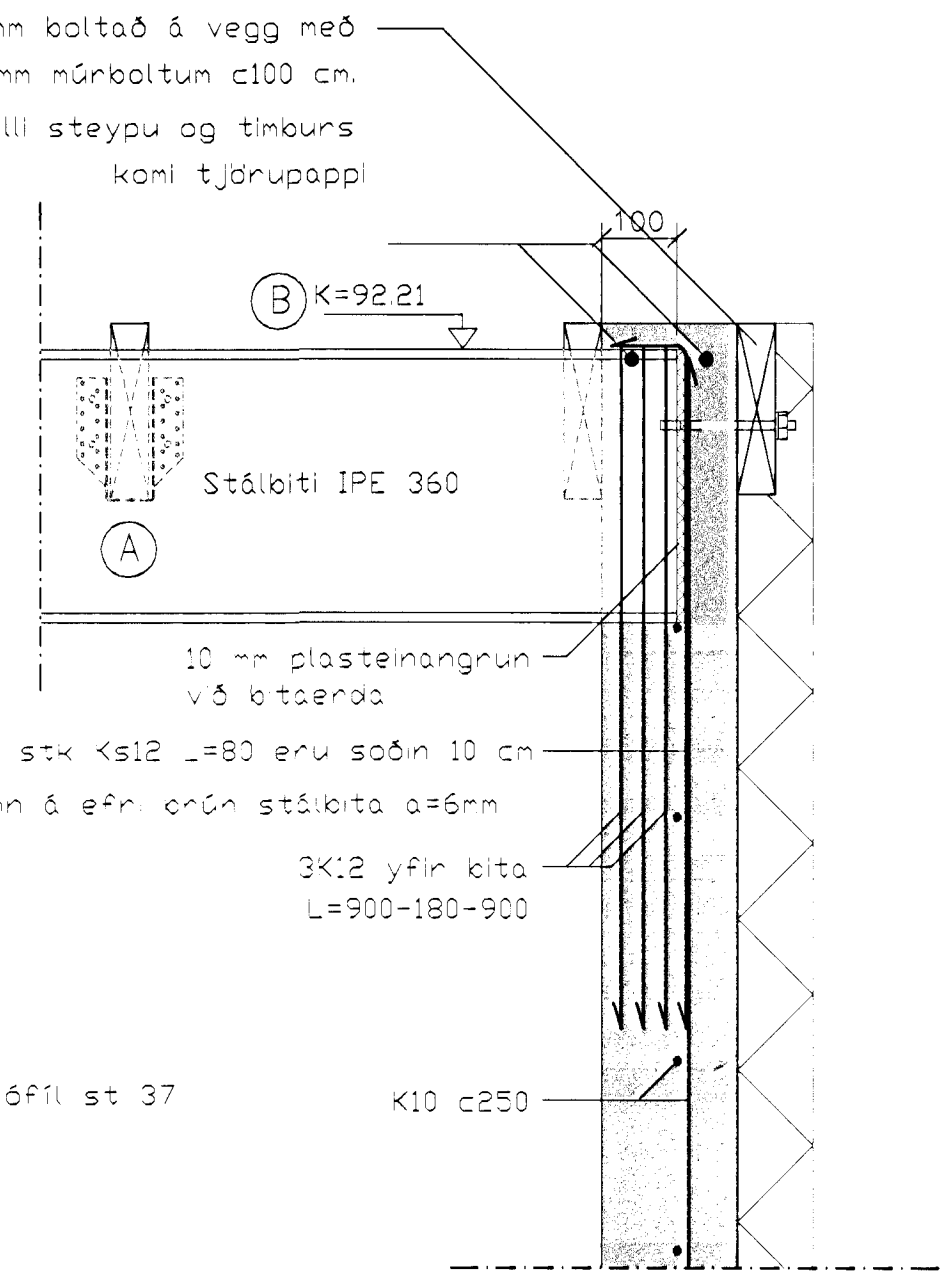

11 Deili 11
8 7 Mkv. 1:10

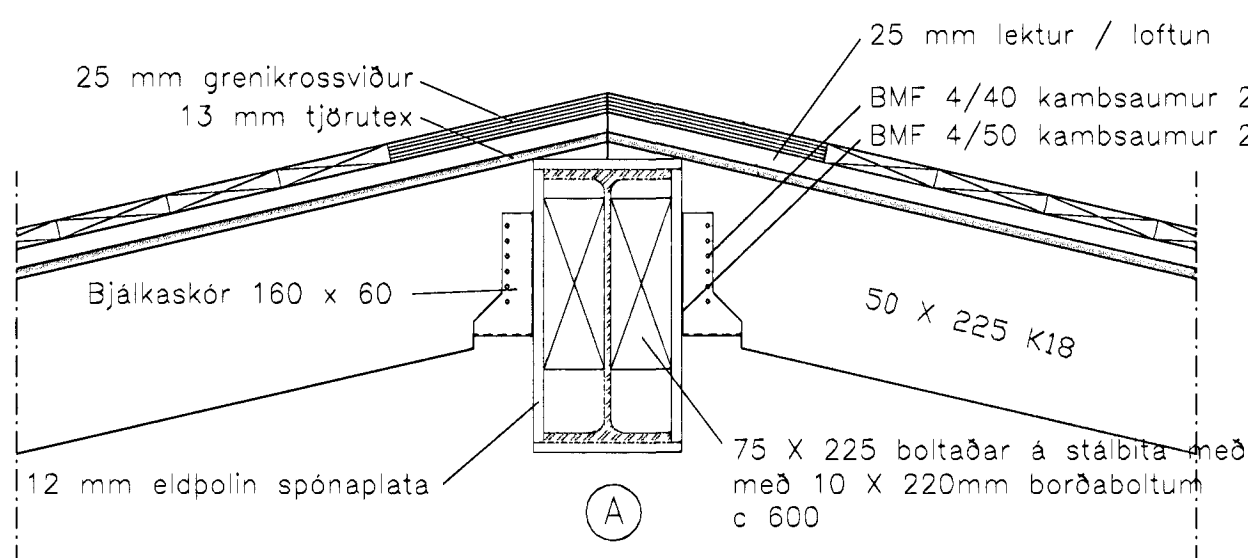

H Snið í mæni, SF-4
8 7 Mkv. 1:10

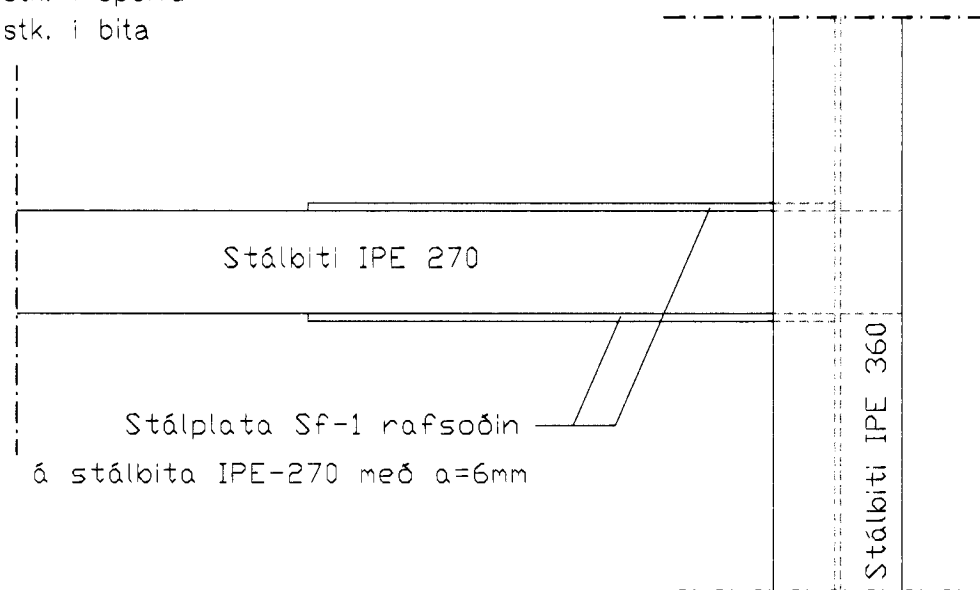

M
8 7 Mkv. 1:10

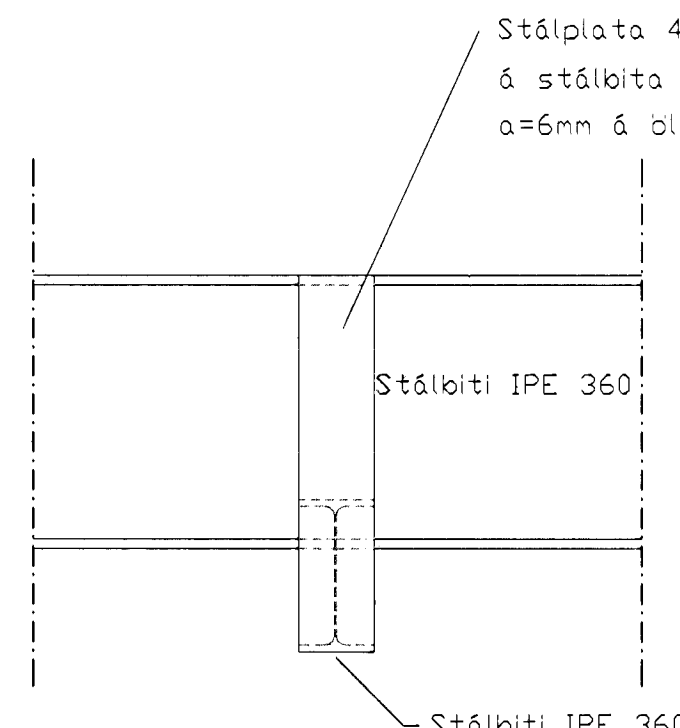

L
8 7 Mkv. 1:10

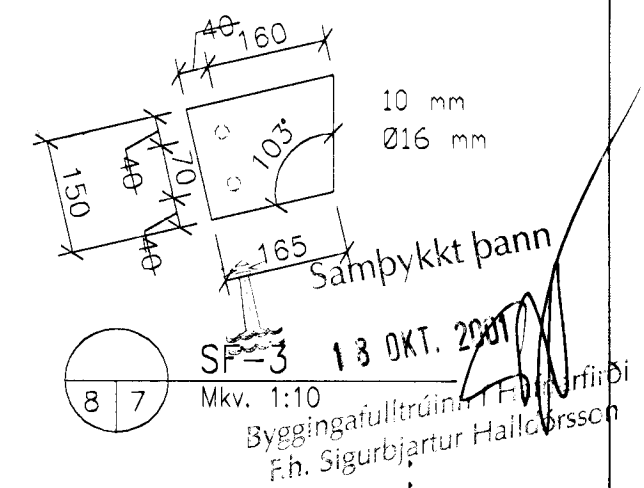

SF-3 13 OKT. 2001
Mkv. 1:10
Byggingaulltrúin, Páll Kertan
F.h. Sigurbjartur Hailósson

Drastarás 23, Hafnarf.

Telkn.nr.: 08	
Mælt:	Samþykkt: <i>S. Hald</i>
Hannað: Páll Kertan	Daga.: 22.08.2001
Telknað: Páll Kertan	M.kv.: 1:10
Breytt:	

- A 11/10 2001 - Breyting á festingu sperra við stálbita
- B 11/10 2001 - Stálbitar hækkaðir um 70 mm