

SUDVESTUR  
MKV. 1:100

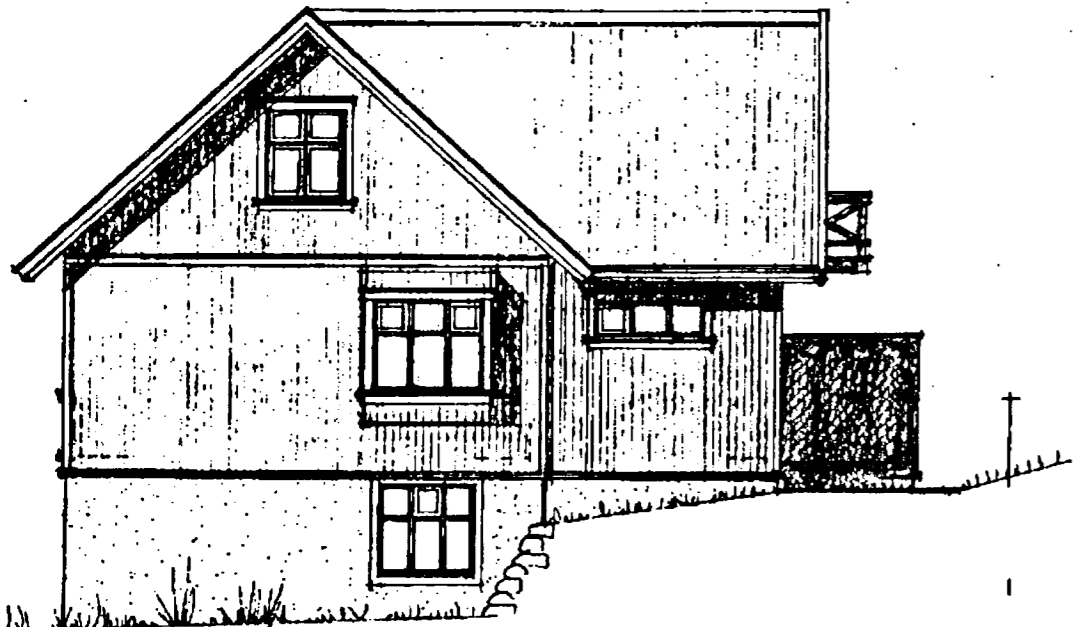

NORDAUSTUR  
MKV. 1:100

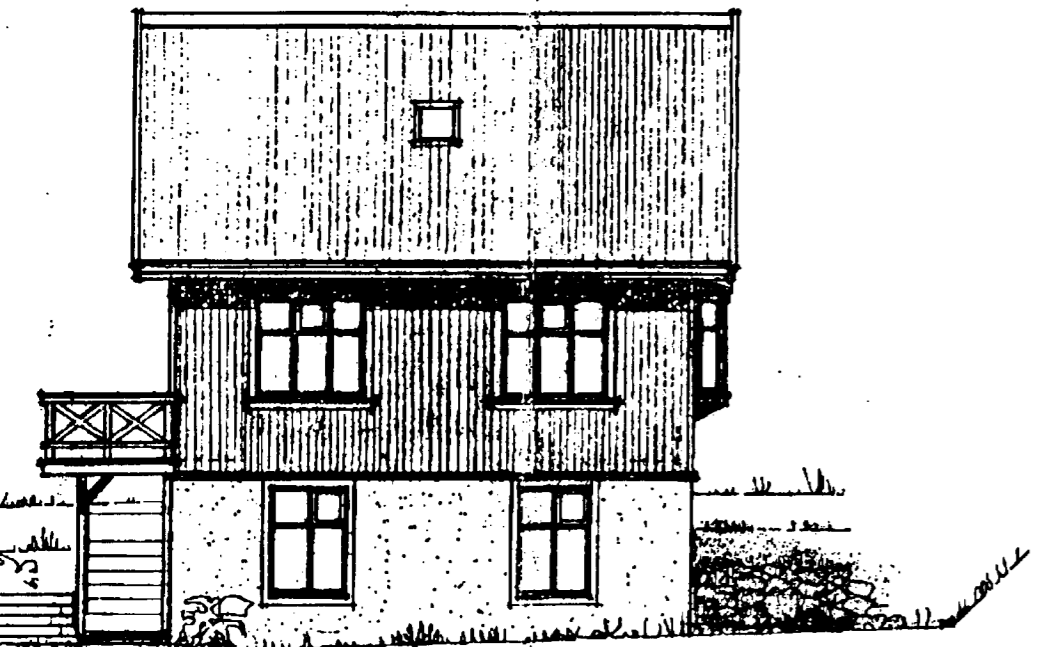

SUDAUSTUR  
MKV. 1:100

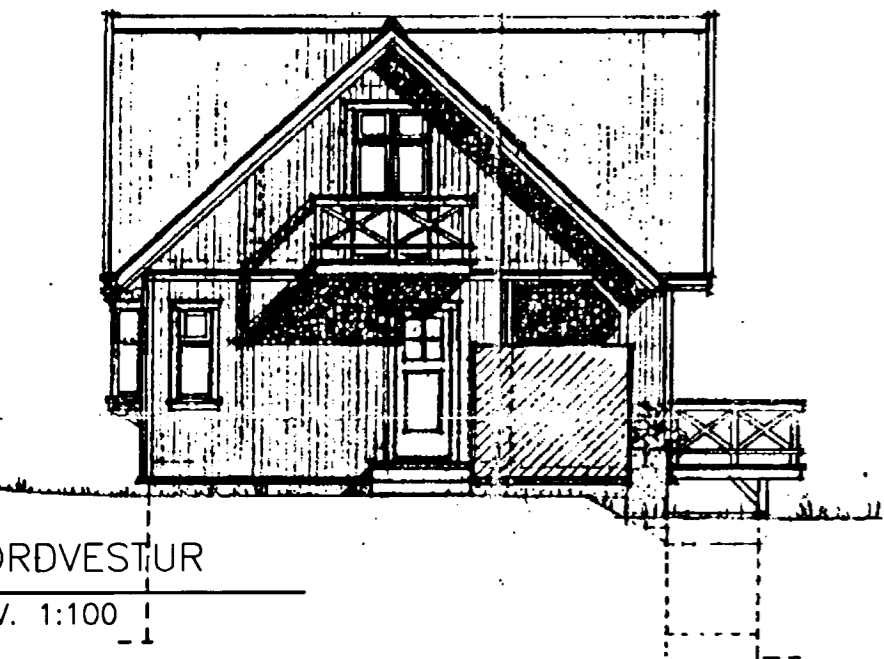

NORDVESTUR  
MKV. 1:100

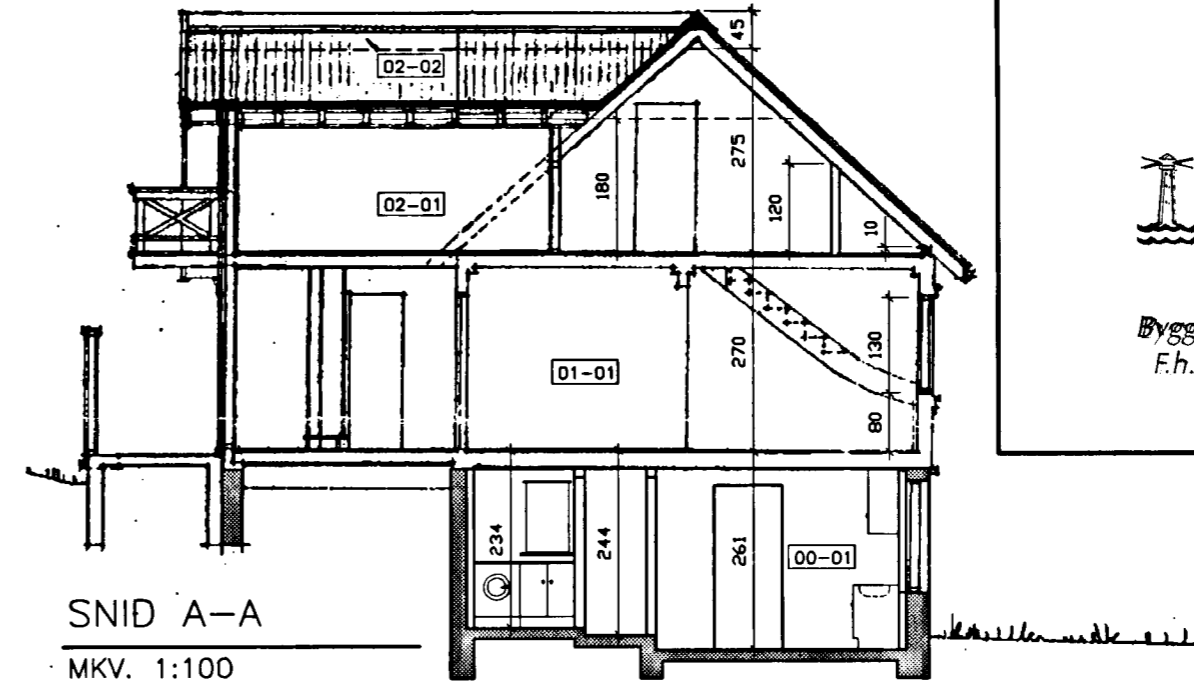
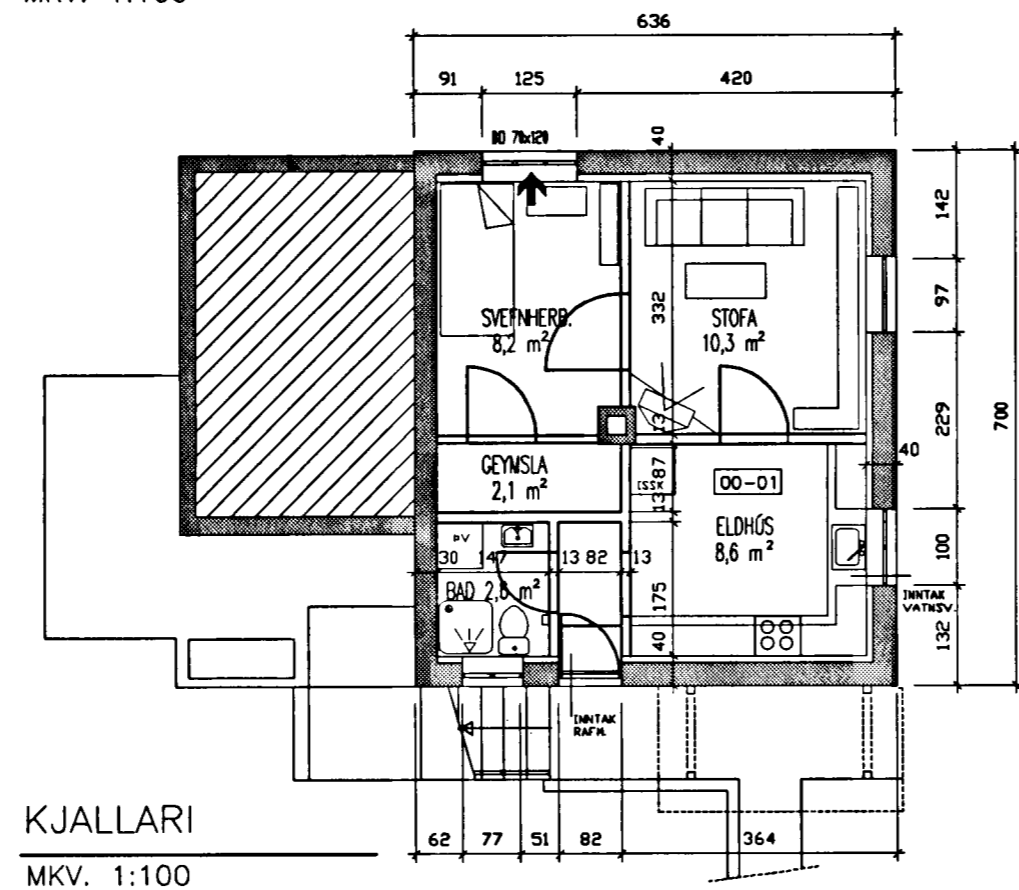
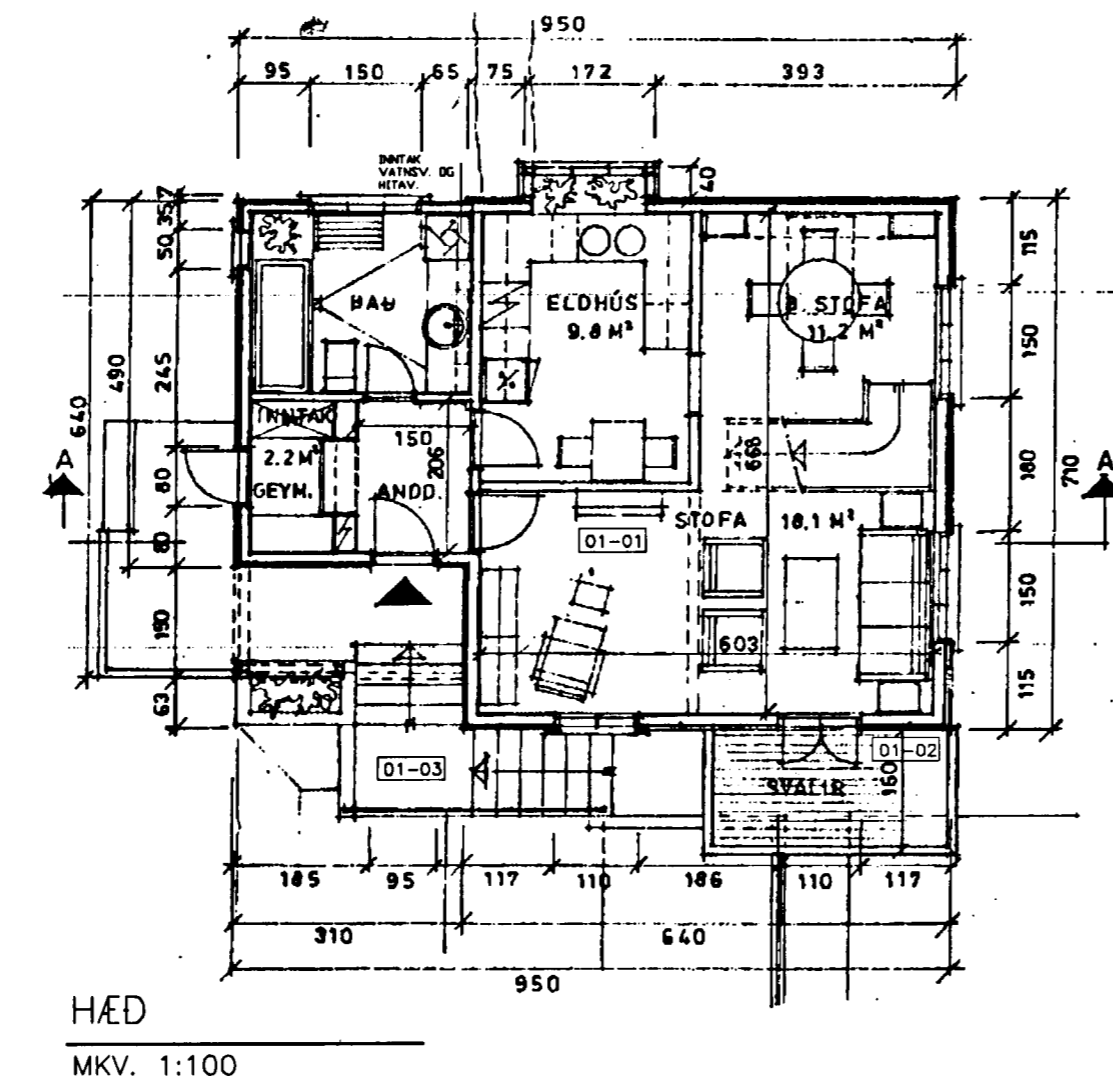
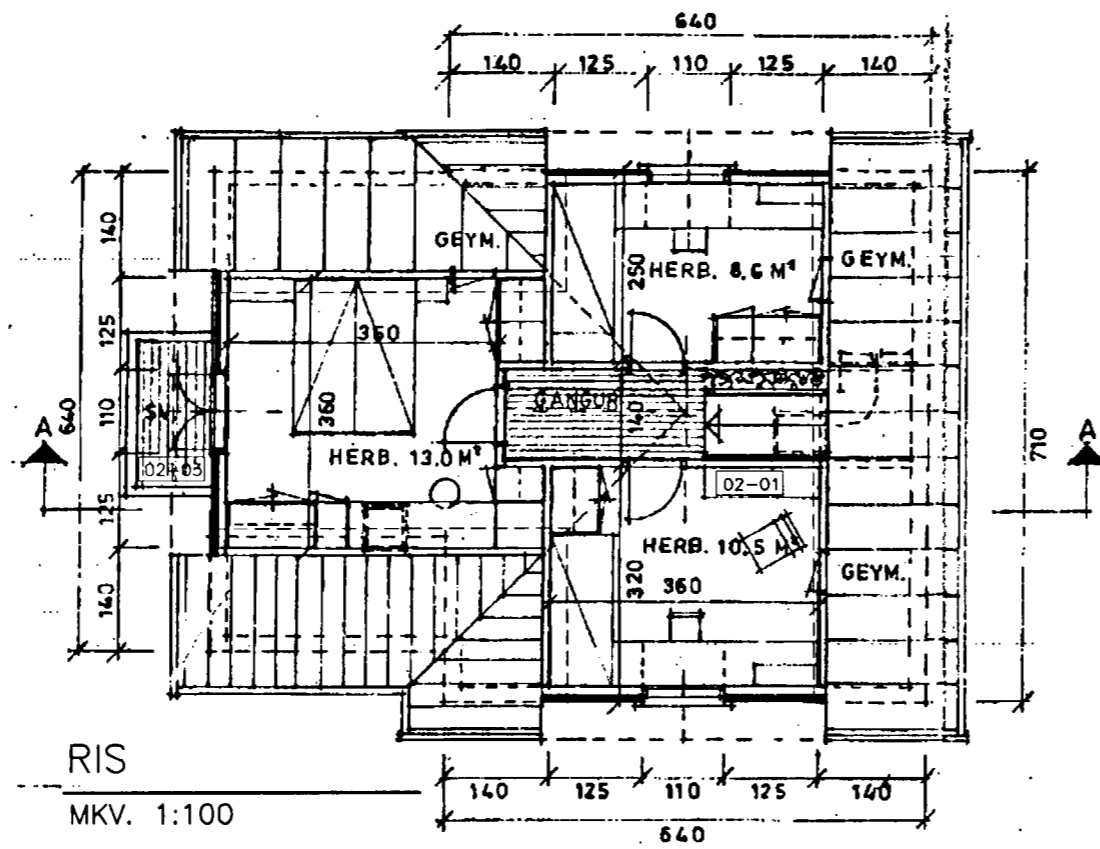

AFSTÖÐUMYND  
MKV. 1:500

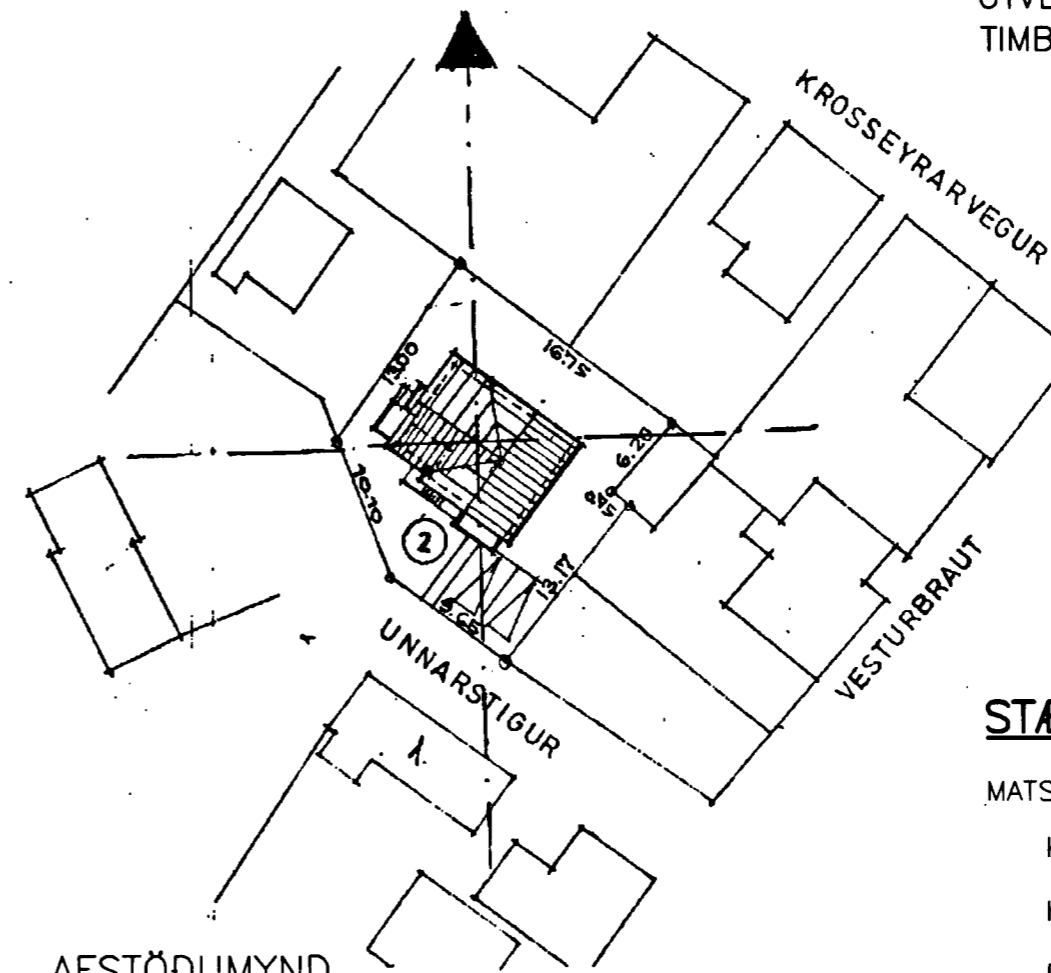

Samþykkt þann

14 JULI 2004

Byggingafulltrúinn í Hafnarfirði  
F.h. Sigurbjartur Halldórsson

**BYGGINGARLÝSING:**

ÍBÚÐARHÚS, KJALLARI, HÆÐ OG RIS. KJALLARI ER STEINSTEYPUR, HÆÐ OG RIS TIMBUR KLÈTT JÁRNI. ÞAK ER TÍHALLA MÈÐ KVISTUM KLÈTT JÁRNI. KJALLARI ER EINANGRADUR INNAN Á ÚTVEGGJUM. GLUGGAR OG HURDIR ERU ÚR TIMBRI. GLER ER TVÖFALT K-GLER.

**STÆRDIR:**

| MATSHLUTI 01 | FLATARMÁL            | RÚMMÁL               |
|--------------|----------------------|----------------------|
| KJALLARI     | 44,5 m <sup>2</sup>  | 111,9 m <sup>3</sup> |
| HÆÐ          | 60,6 m <sup>2</sup>  | 163,6 m <sup>3</sup> |
| RIS          | 65,3 m <sup>2</sup>  | 124,0 m <sup>3</sup> |
| SAMTALS:     | 170,4 m <sup>2</sup> | 399,5 m <sup>3</sup> |
| LÓDARSTÆRD:  | 309,3 m <sup>2</sup> |                      |
| LÓDARNÝTING: | 170,4/309,3=0,55     |                      |

REYNDARTEIKNING AF HÚSI Á LÓÐ UNNARSTÍGS 2. BYGGT Á TEIKNINGU ÓLA ÞÓRDARSONAR SAMÞYKKT Í BYGGINGARN. HAFNARF. 18/9/1986.

**UNNARSTÍGUR 2, HAFNARFIRÐI**

|   |            |
|---|------------|
| AFSTÖÐUM., GRUNNMYNDR, SNEIDING, BYGGINGARLÝSING OG STÆRDIR | TEIKN: 01  |
| TEIKNAD Í REYKJAVÍK, JÚNÍ 2004                              | TEIKN, AVH |
| AXEL V. HILMARSSON K.Í. 250365-3819, BYGGINGARVERKFR.       | REIKN, AVH |
| VILHJÁLMMUR GUDMUNDSSON K.Í. 030843-2319, FVFI              | YFIRF, VG  |