

SNIED 1 x 1:20

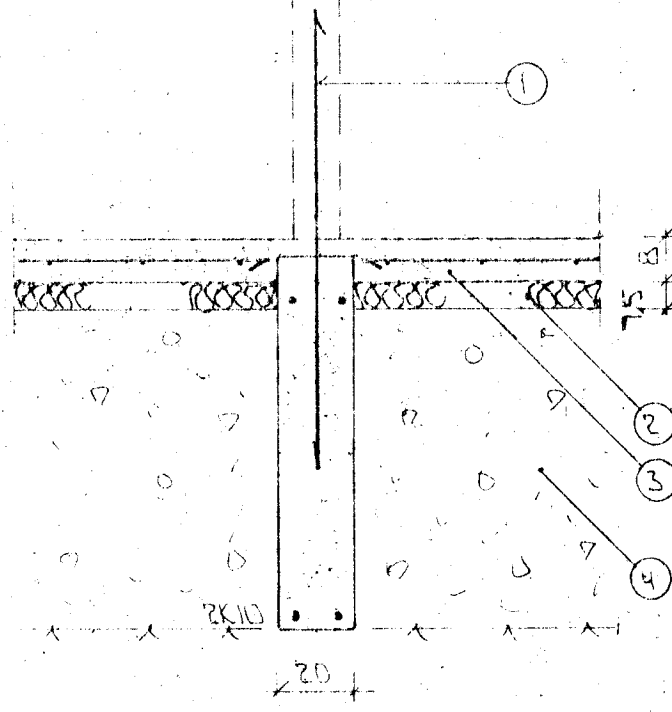

SNIED 2 x 1:20

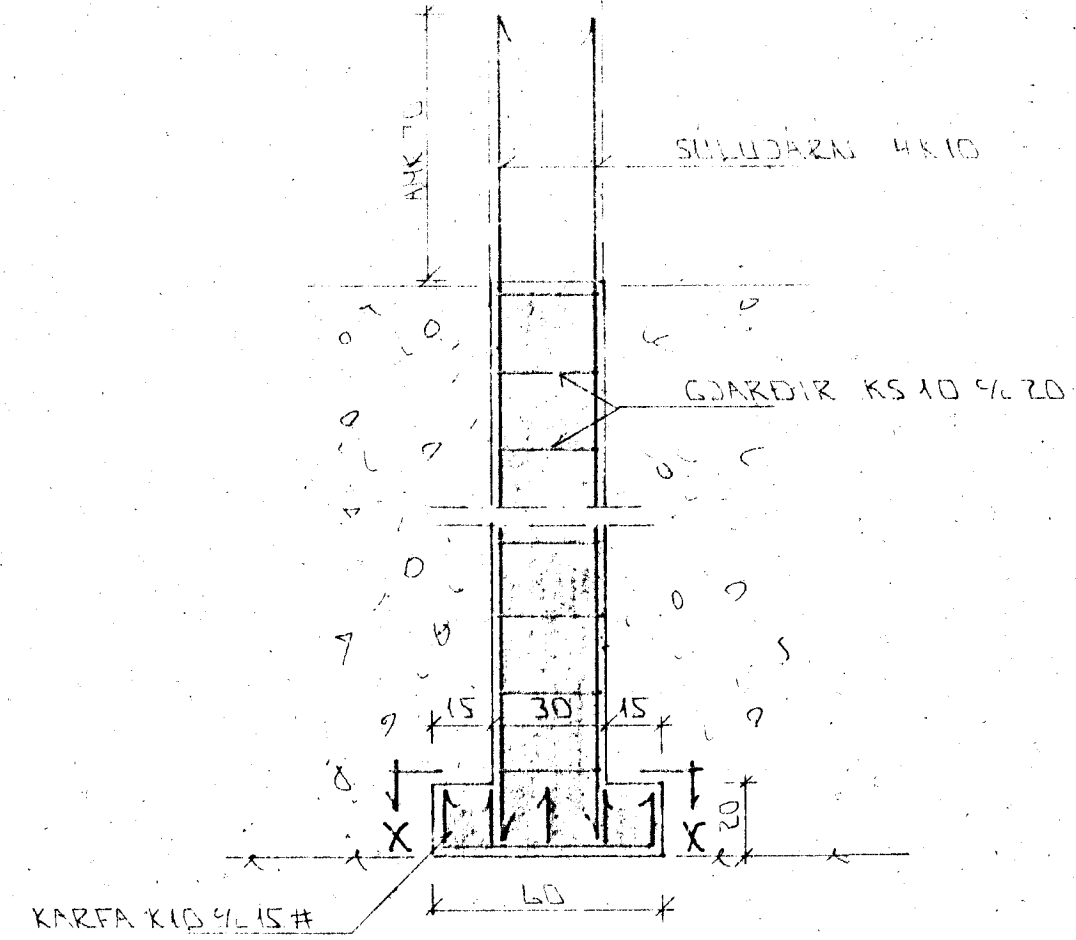

SNILA S1 x 1:20

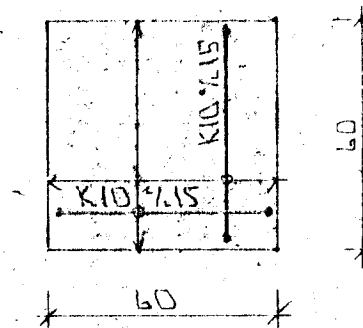

SNIED X-X x 1:20

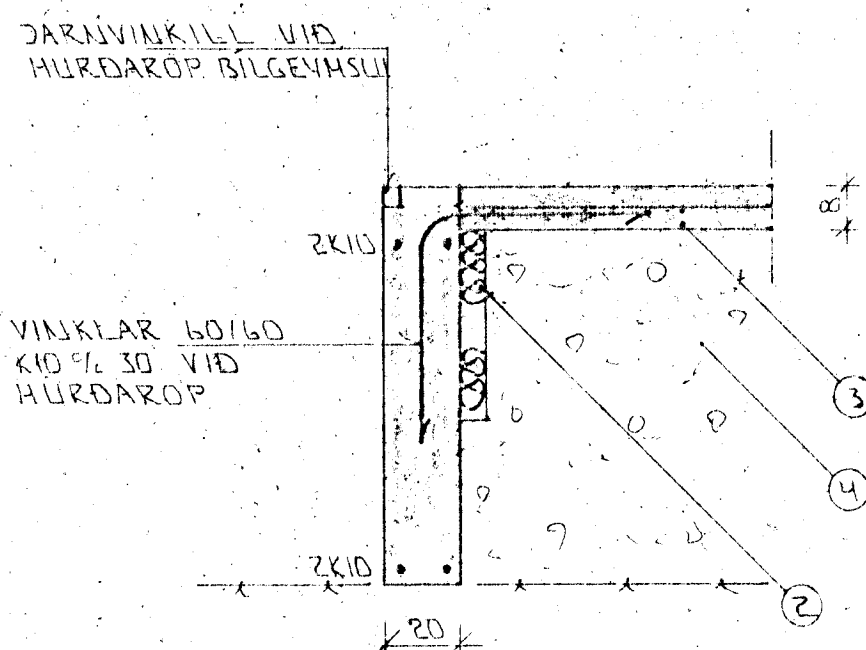

SNIED 3 x 1:20

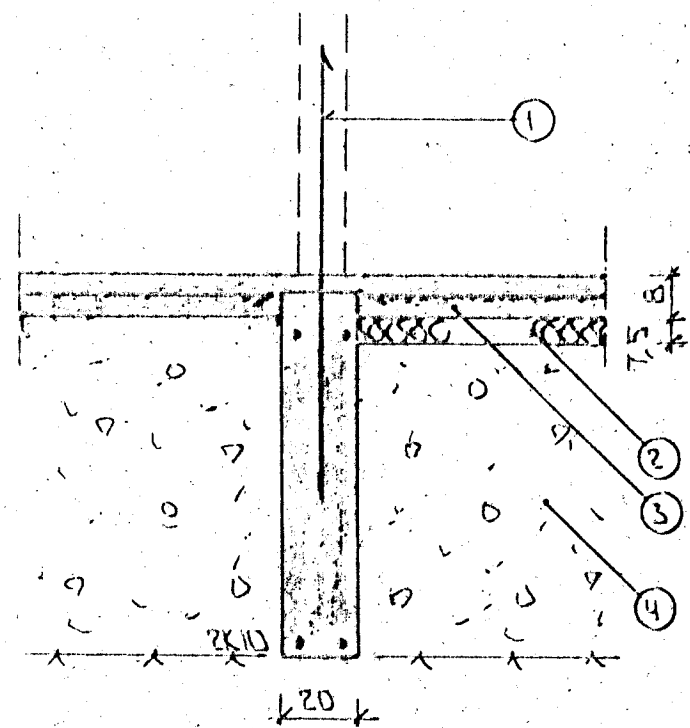

SNIED 4 x 1:20

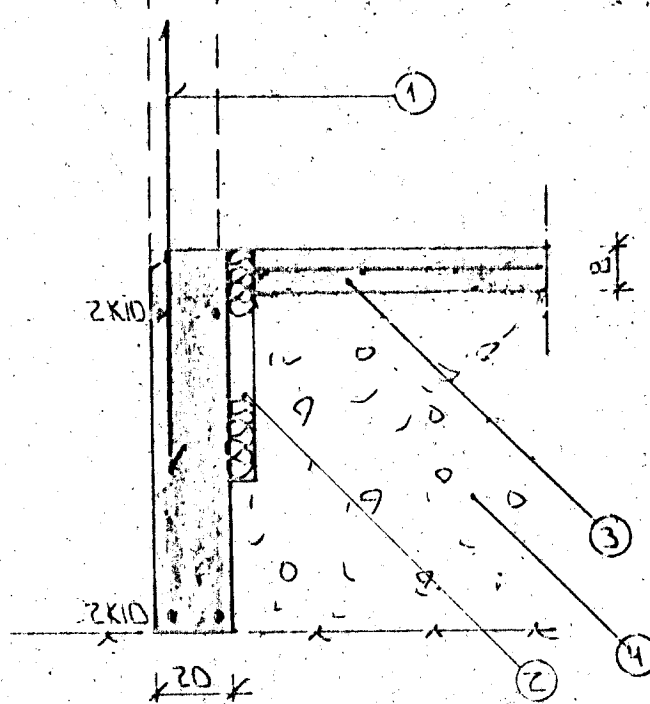

SNIED 5 x 1:20

SKÝRINGAR

ALMENNAR SKÝRINGAR SJÁ BLAD NR 1-01

- 1-- TENGIJARN K 10 c/c 30 SM L=120 SM OG STANDI AMK 50 SM YFIR FLÖTU
- 2-- 15MM PLAST/STEINULLAREINANGRUN HARDFRESSUÐ EINANGRUNIN MÁ AMK 50 SM NIÐUR MED ÖTVEGGJUM EINSAM EINANGRUN UNDIR FLÖTU BILGEYNSLU NÉ INNIAKSKLEFA
- 3-- 8 SM STEYPT PLATA JARNBENT AMK 8 0 c/c 25 # EDA K 10 c/c 30 #
- 4-- GRÖSAR EÐA HRAUNFYLING FROSTFRI OG ÞJAFPIST Í LÖGUM MED TITRAÞJÖPPU LAGÞYKKT RÁÐIST AF GERÐ ÞJÖPPUNNA
- 5-- EFST OG NEÐST Í ÖLLUM SÖKKULVEGGJUM KOMI 2 K 10 JARNIN SEU HEIL OG SAMFELD UM HORN ÞAR SEM JARNIN ERU SKEYTT SKULU ÞAU MISVÆLAST UM SKEYTILENGD 40 SM ÞAR SEM VEGGHÆÐ ER HERRI EN 120 SM KOMI EINFÖLD GRIND Í MIÐJAN VEGG K 10 c/c 30 # NEMA ANNAD SE SYNT Í SNIDMYNDUM UNDIR. ATHYGLI ER VAKIN Á ÁKVÆÐUM RAÐVEITU UM SAMTENGINGU JARNA SJÁ TEIKNINGU RAFLAGNAHÖNNUNAR

STEYPA
 $S \geq 250$ $V/S < 0,5$
 LÖFTINNIHALD $\geq 6\%$
 SEMENT ≥ 300 KG/M³

BR. DAGS. EDLI BR. SIGN.

VESTURHOLT 13
 HAFNARFIRÐI

SNIED Í UNDIRSTÖÐUR

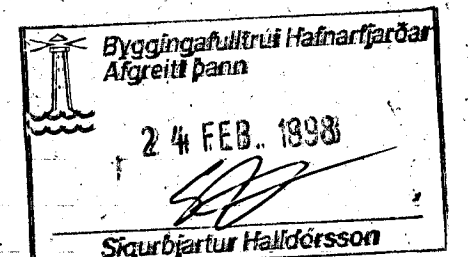

MKV x 1:20
 DAGS. FEB '98
 VERK NR. 9802
 TEIKN NR. 1-03
 HANNAD G.H.
 TEIKNAD G.H.
 YFIRFARID

TEKNIÞJÓNUSTA
SIGURDAR ÞORLEIFSSONAR ehf

STRANDGÖTU 11 - 220 HAFNARFJÖRDUR - Sími 565 4255 - FAX 565 2875