

S4 U-160, L=3116, 1 stk.  
M. 1:10

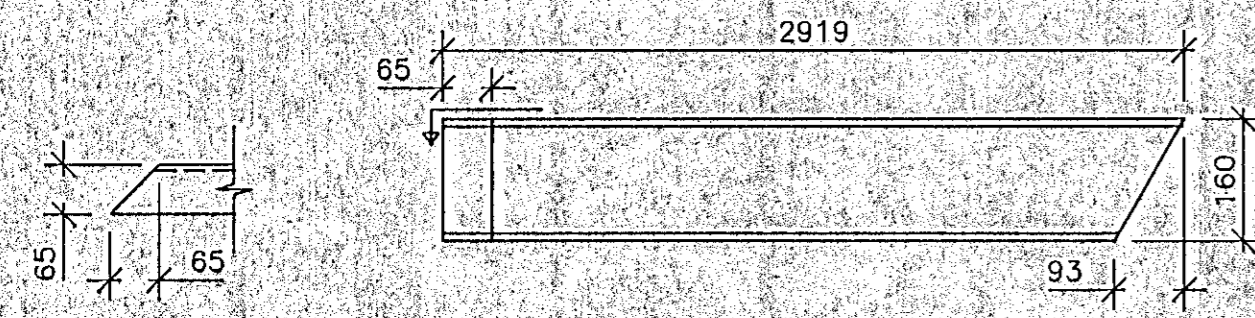

S5 U-160, L=2919, 1 stk.  
M. 1:10

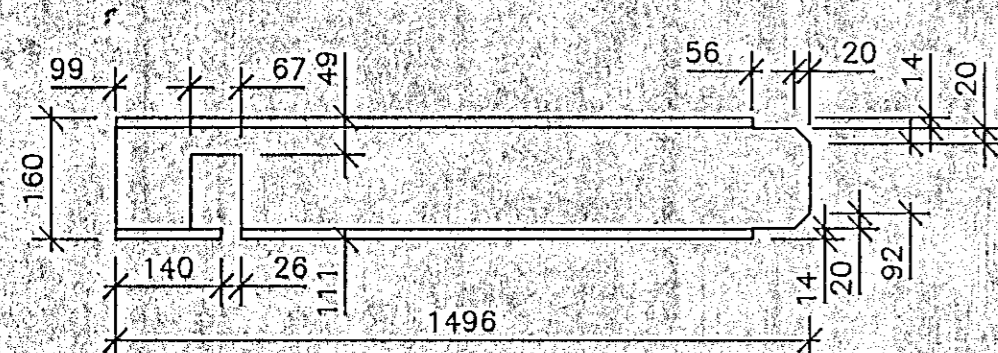

S6 HE160B, L=1496, 1 stk.  
M. 1:10

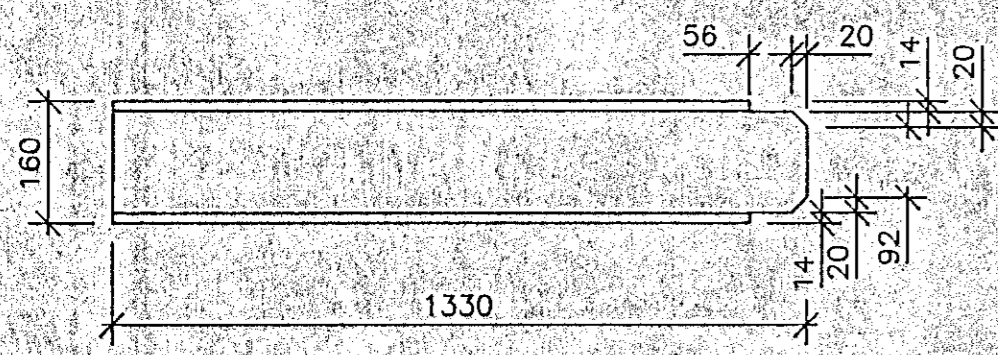

S7 HE160B, L=1330, 1 stk.  
M. 1:10

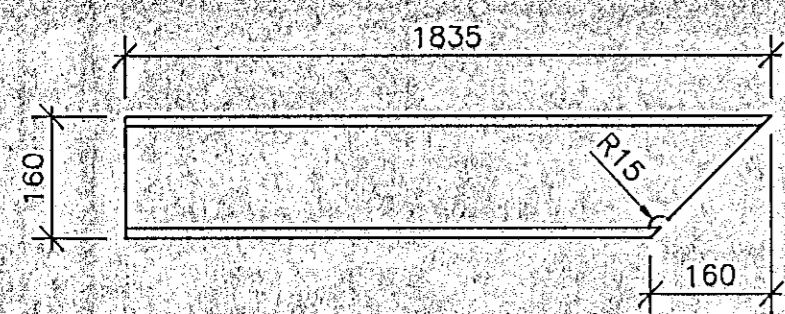

S8 HE160B, L=1835, 1 stk.  
M. 1:10

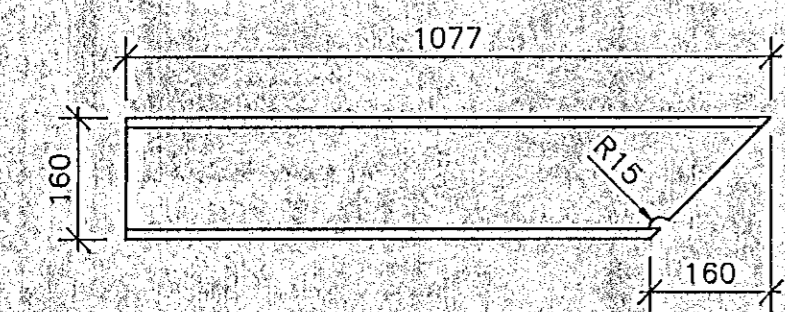

S9 HE160B, L=1077, 1 stk.  
M. 1:10

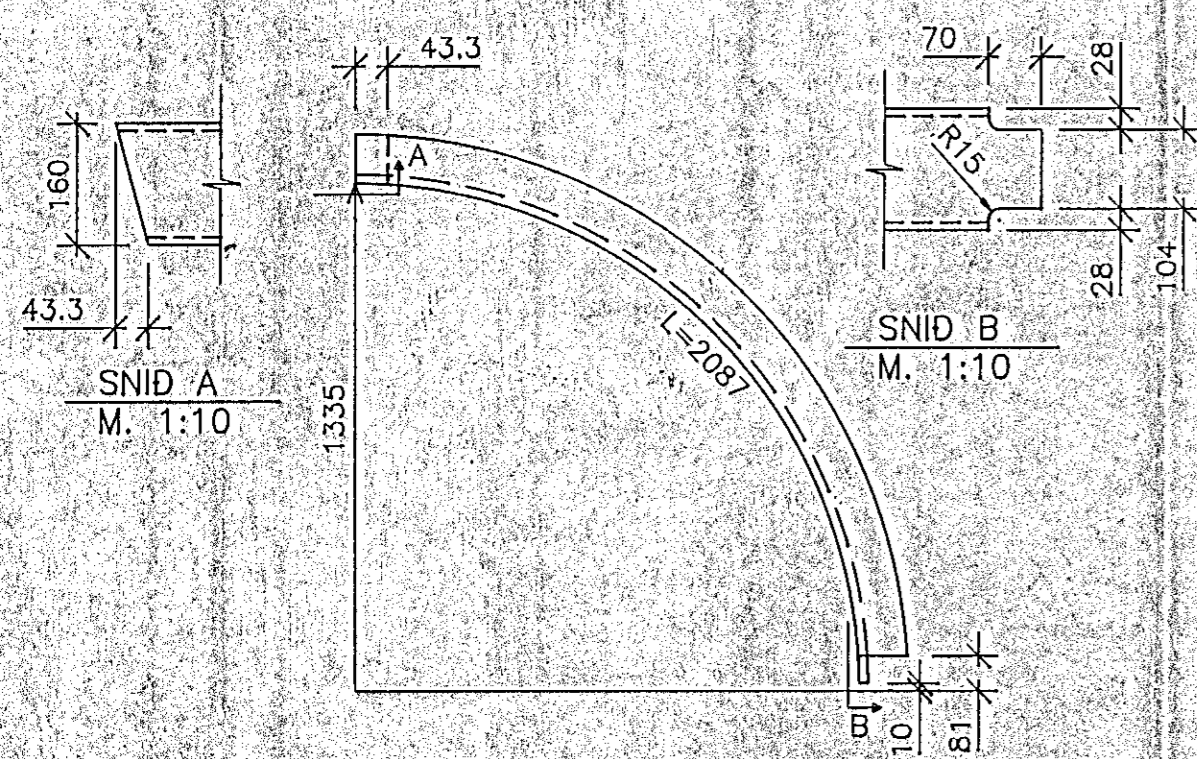

S10 U-160, L=2087, 1 stk.  
OKVARDAD

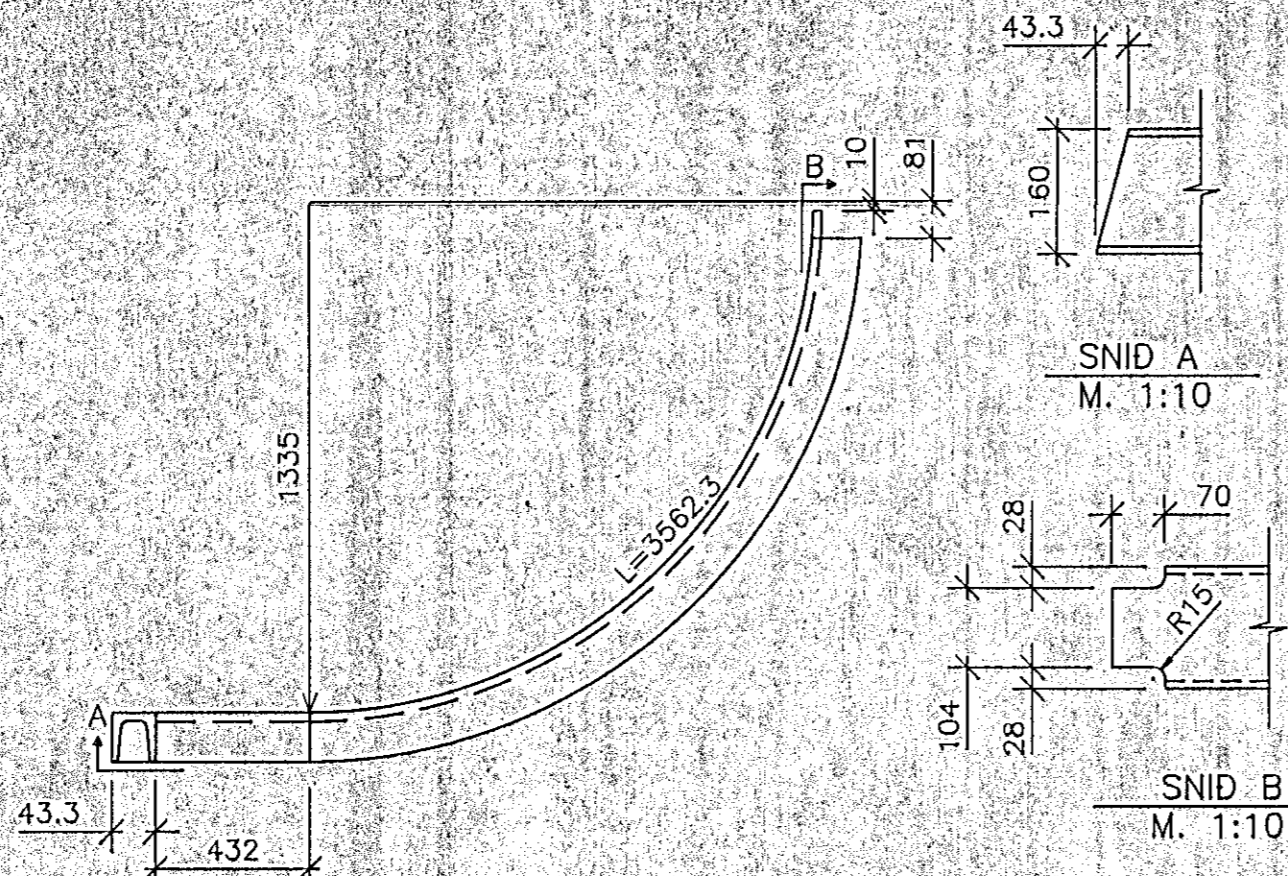

S11 U-160, L=3562.3, 1 stk.  
OKVARDAD

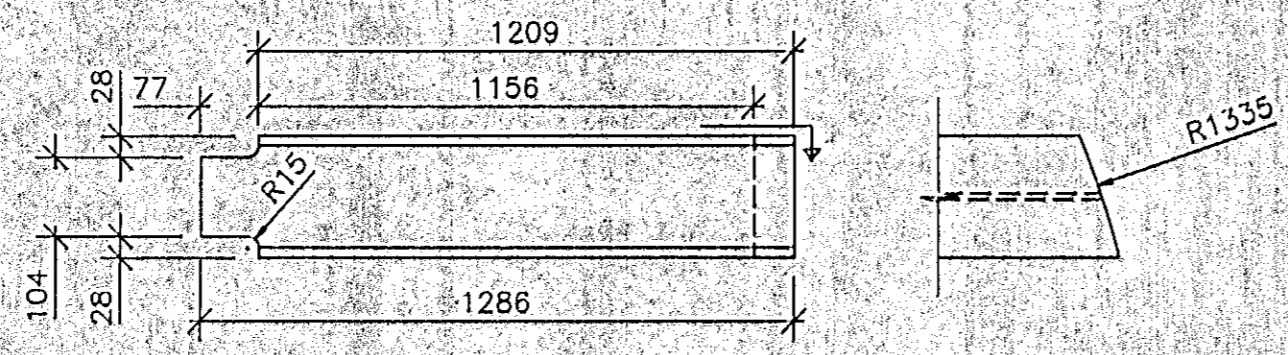

S12 HE160B, L=1286, 2 stk.  
M. 1:10

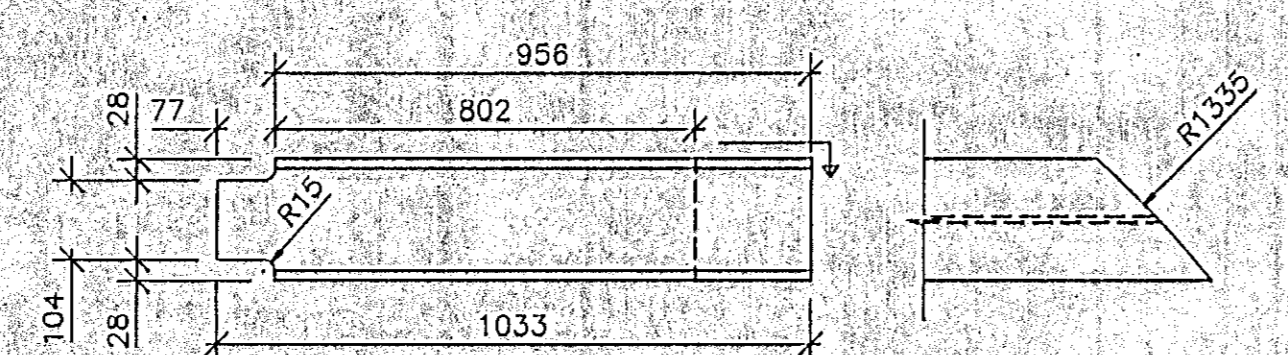

S13 HE160B, L=1033, 2 stk.  
M. 1:10

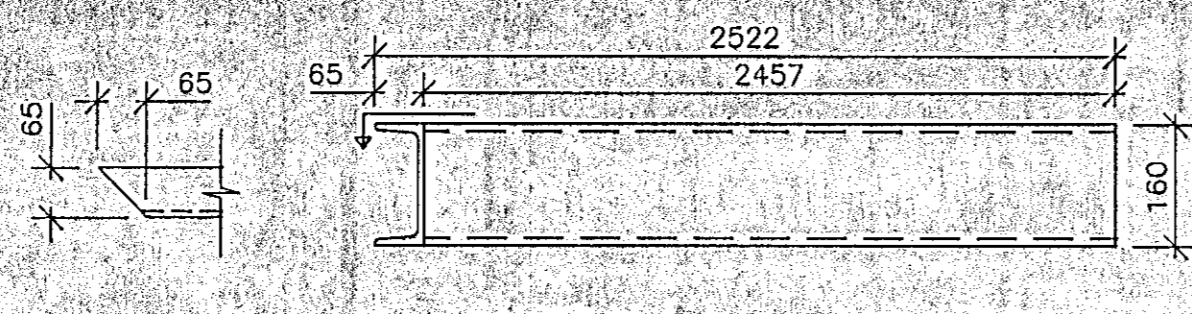

S14 U-160, L=2522, 1 stk.  
M. 1:10

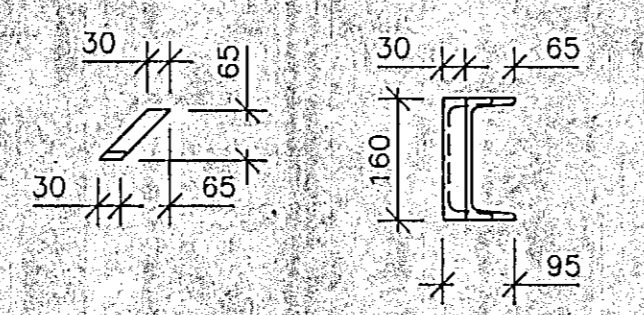

S15 U-160, L=95, 1 stk.  
M. 1:10

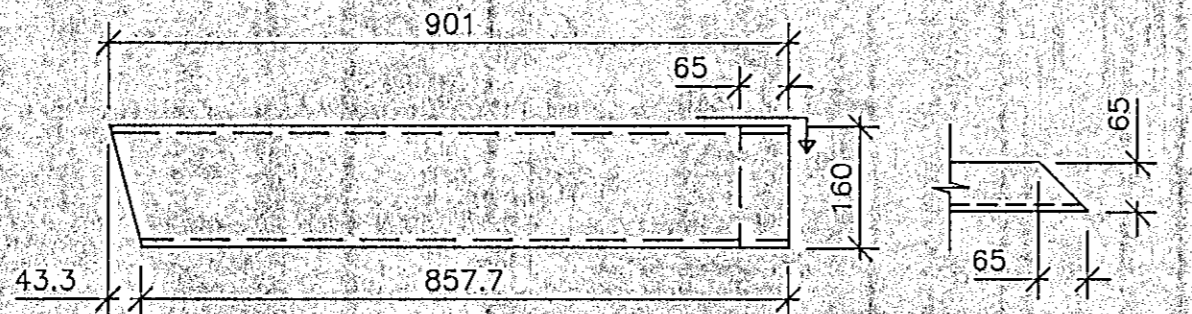

S16 U-160, L=901, 1 stk.  
M. 1:10

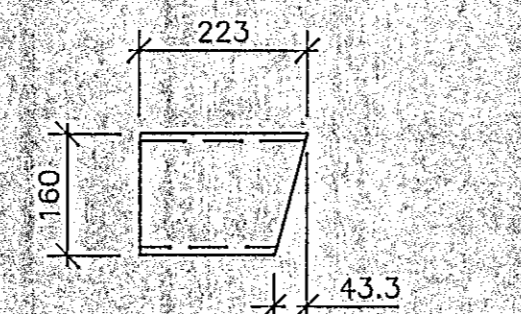

S17 U-160, L=223, 1 stk.  
M. 1:10

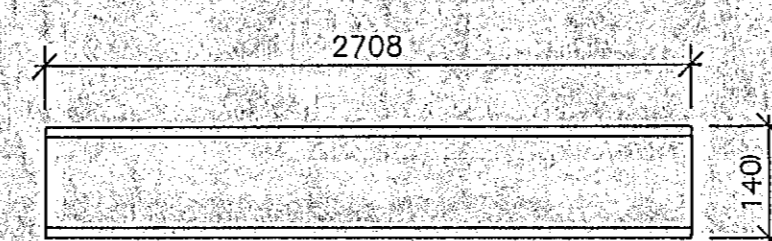

S18 U-140, L=2708, 1 stk.  
M. 1:10

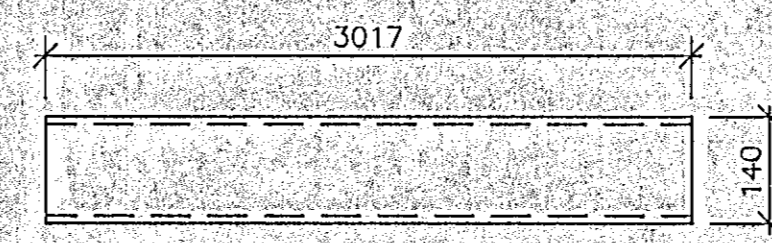

S19 U-140, L=3017, 1 stk.  
M. 1:10

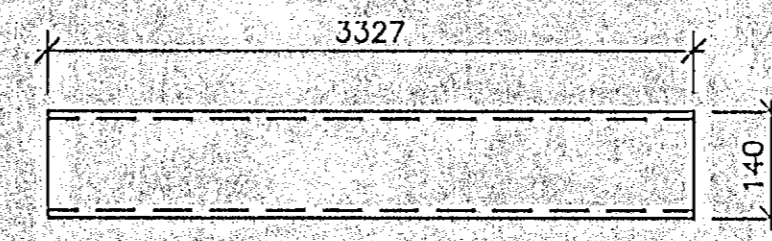

S20 U-140, L=3327, 1 stk.  
M. 1:10

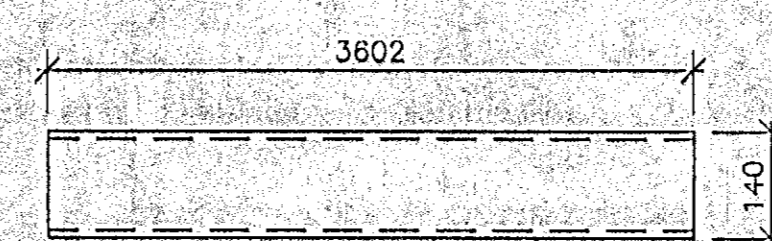

S21 U-140, L=3602, 1 stk.  
M. 1:10

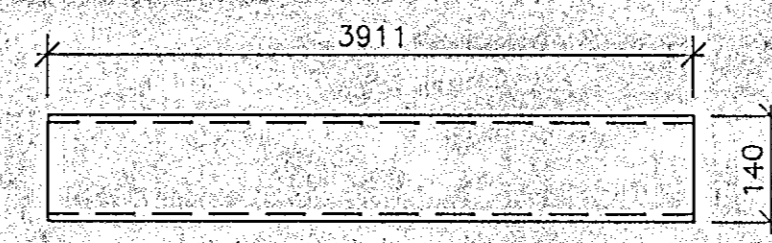

S22 U-140, L=3911, 1 stk.  
M. 1:10

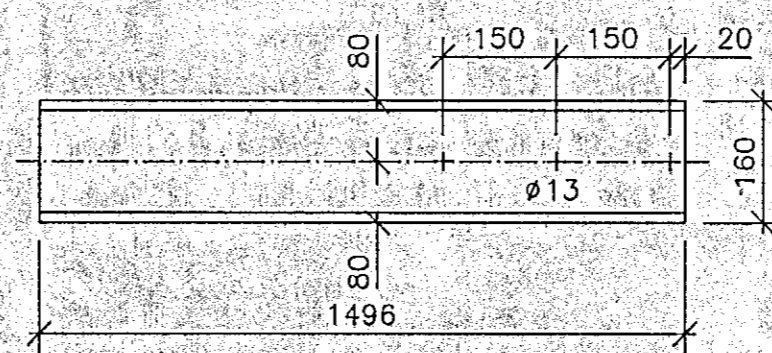

S23 U-160, L=1496, 1 stk.  
M. 1:10

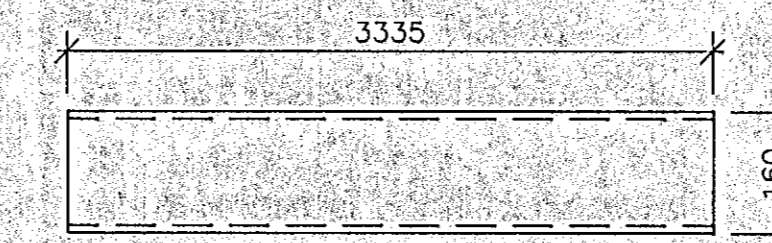

S24 U-160, L=3335, 1 stk.  
M. 1:10

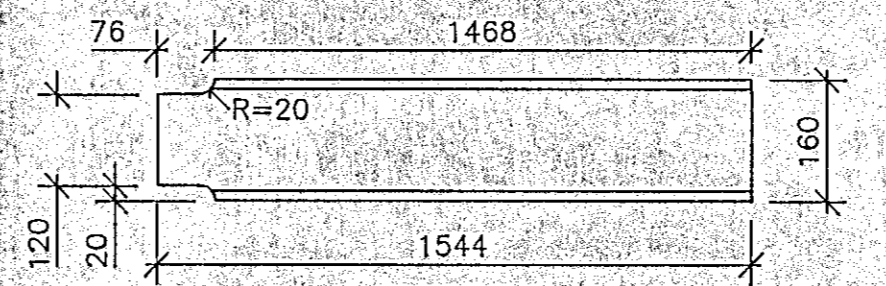

S25 HE160B, L=1544, 2 stk.  
M. 1:10

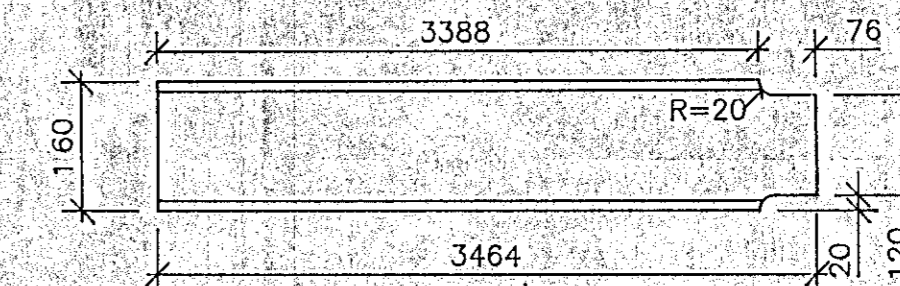

S26 HE160B, L=3464, 2 stk.  
M. 1:10

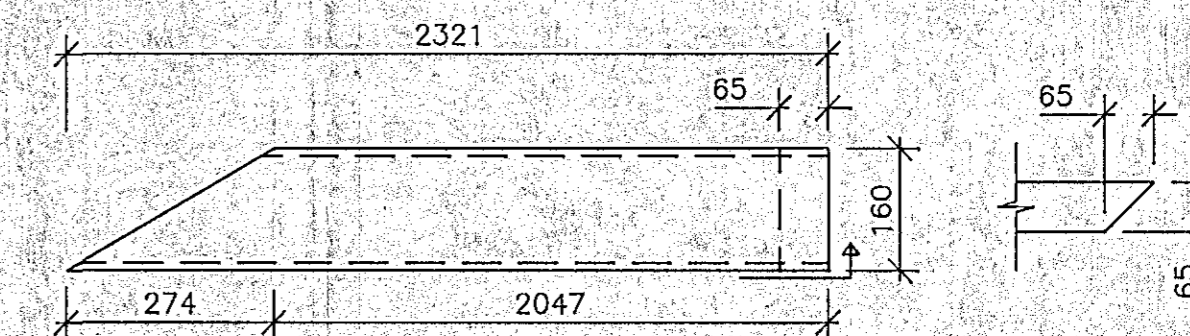

S27 U-160, L=2321, 1 stk.  
M. 1:10

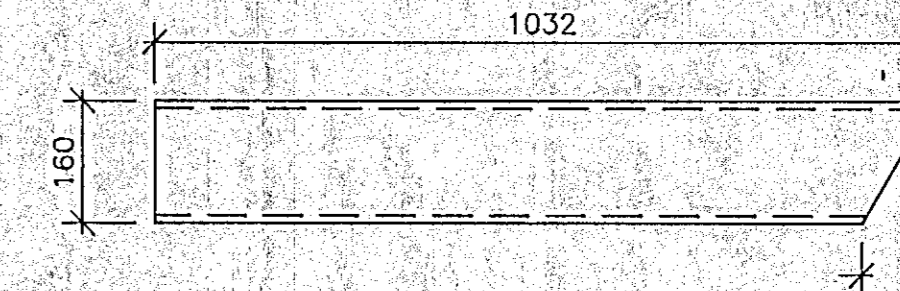

S28 U-160, L=1032, 1 stk.  
M. 1:10

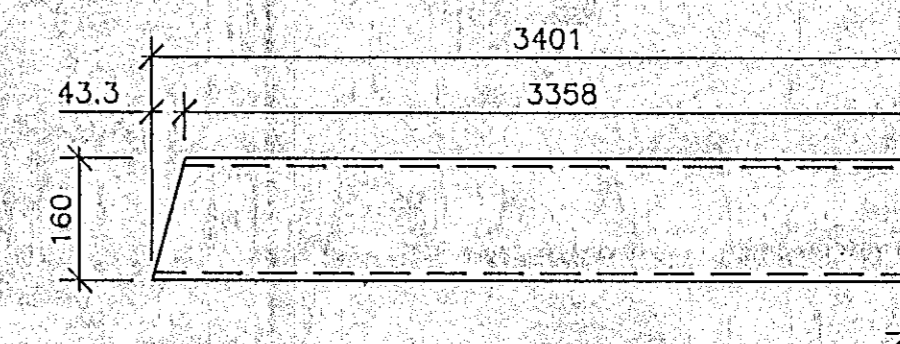

S29 U-160, L=3401, 1 stk.  
M. 1:10

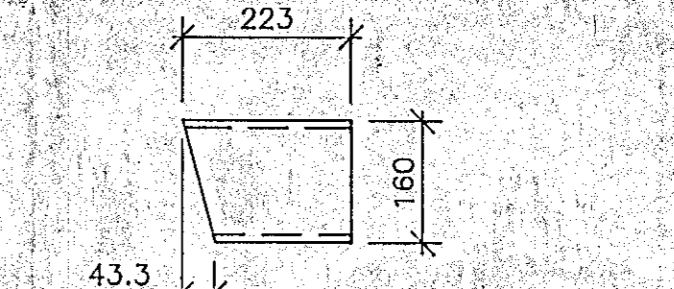

S30 U-160, L=223, 1 stk.  
M. 1:10

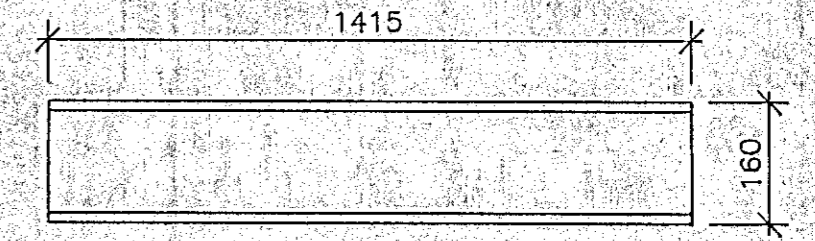

S31 U-160, L=1415, 1 stk.  
M. 1:10

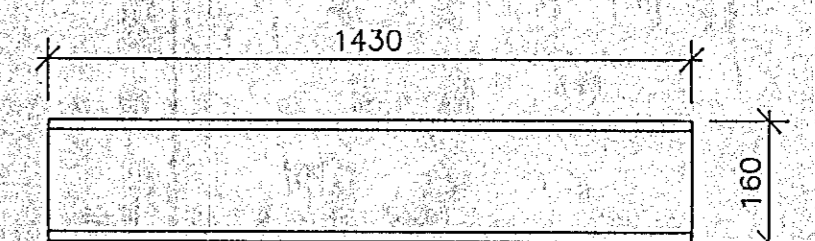

S32 U-160, L=1430, 1 stk.  
M. 1:10

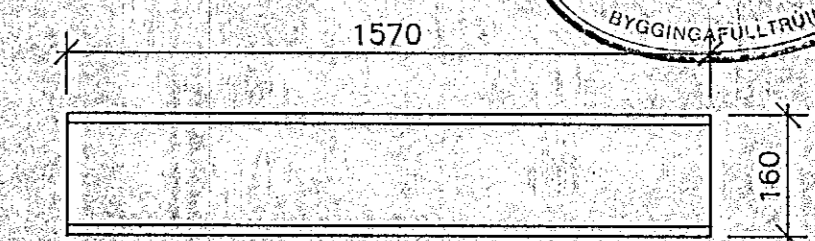

S33 U-160, L=1570, 1 stk.  
M. 1:10

NR FJÖLDI BREYTINGAR DAGS SAMP

**MIDBÆR**  
**HAFNARFJARDAR**  
FJARDARGATA 13-15

ALMENNA  
VERKFRÆÐISTOFAN HF  
FELLSMULA 28 - 108 REYKJAVIK  
SMÍ (91) 678100 FAX (91) 680284

HEITI  
STIGI NR.4  
ADALANDDYRI  
SÉRMYNDIR

MÁL  
1:10  
HANNAÐ  
U. H. / H. P. A. / P. B. / SAMP.  
DAGS  
4/8 1994  
TEIKNING NR.  
1032-B-246  
BREYTING NR.

16 AUG. 1994  
HAFNARFJARDAR  
BYGGINGAFULLTRUW