

**GRUNNMYND AF UNDIRSTÖÐUM MKV. 1:50**

SÖKKLAR ERU STEYPTIR MEÐ EINANGRUNARMÓTUM OG MÁLSETNINGAR MÍÐAST VÍÐ YTRI BRUN A EINANGRUN.

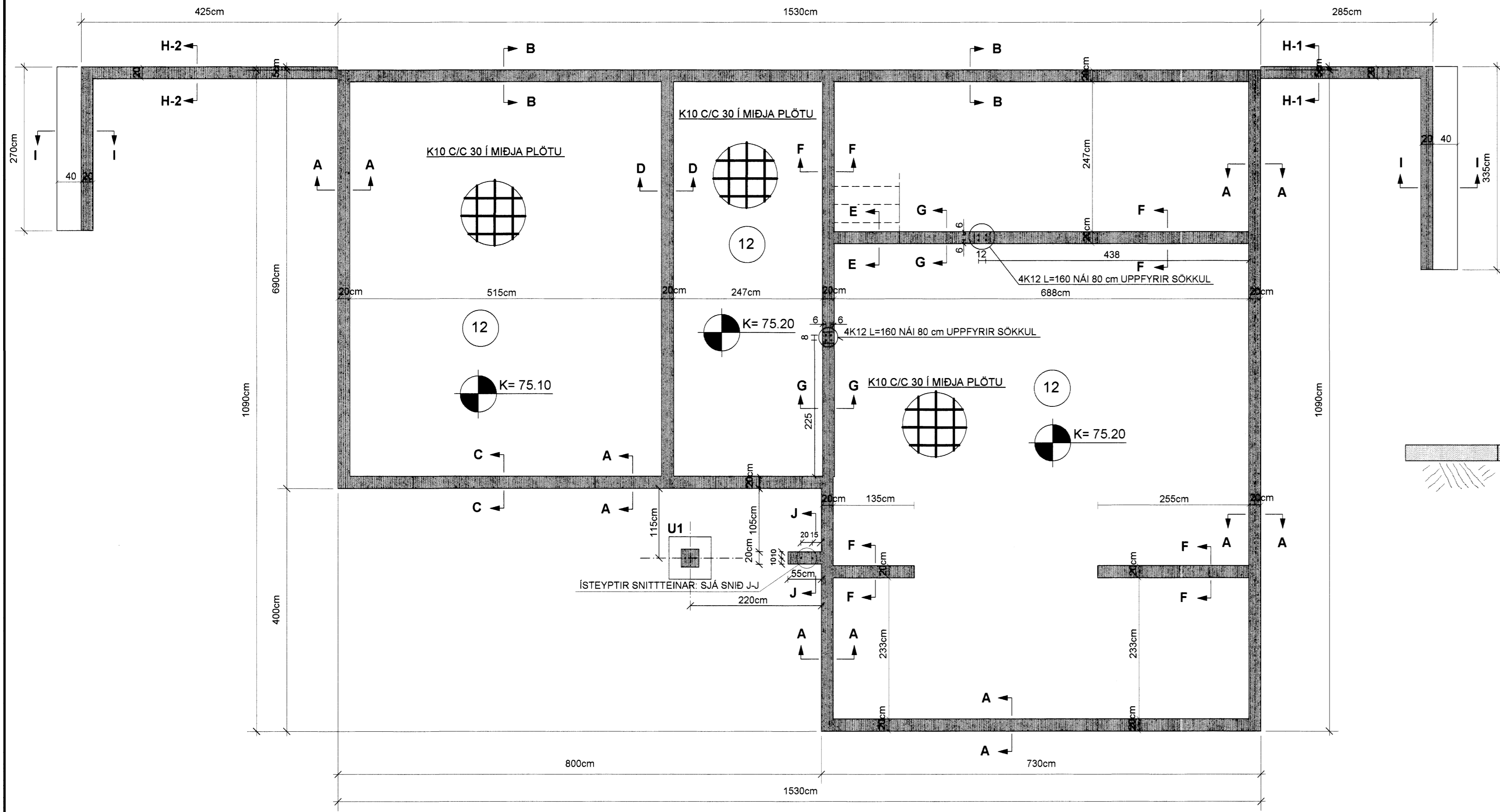

**SNID A-A MKV. 1:10**

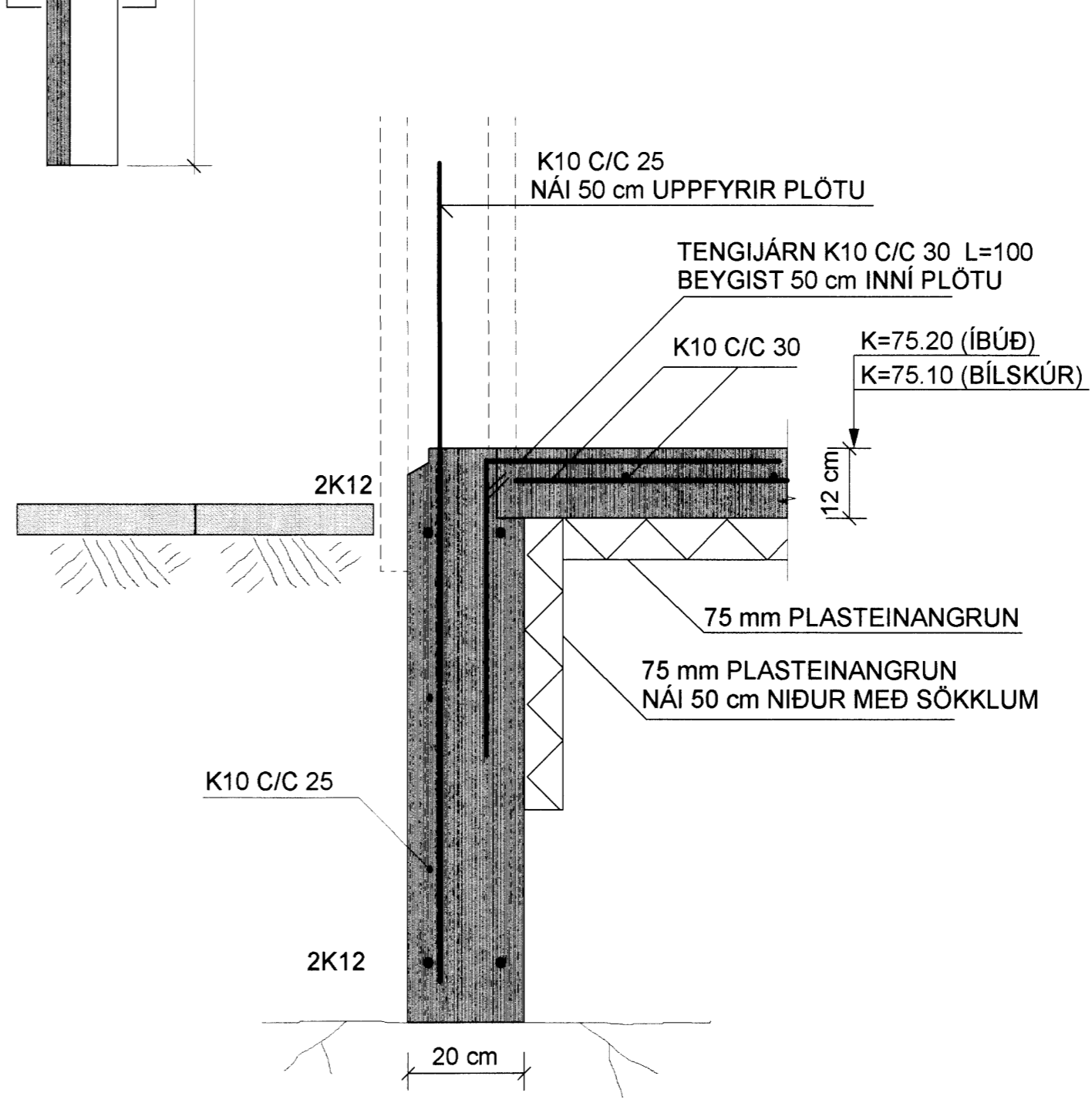

**SNID B-B MKV. 1:10**

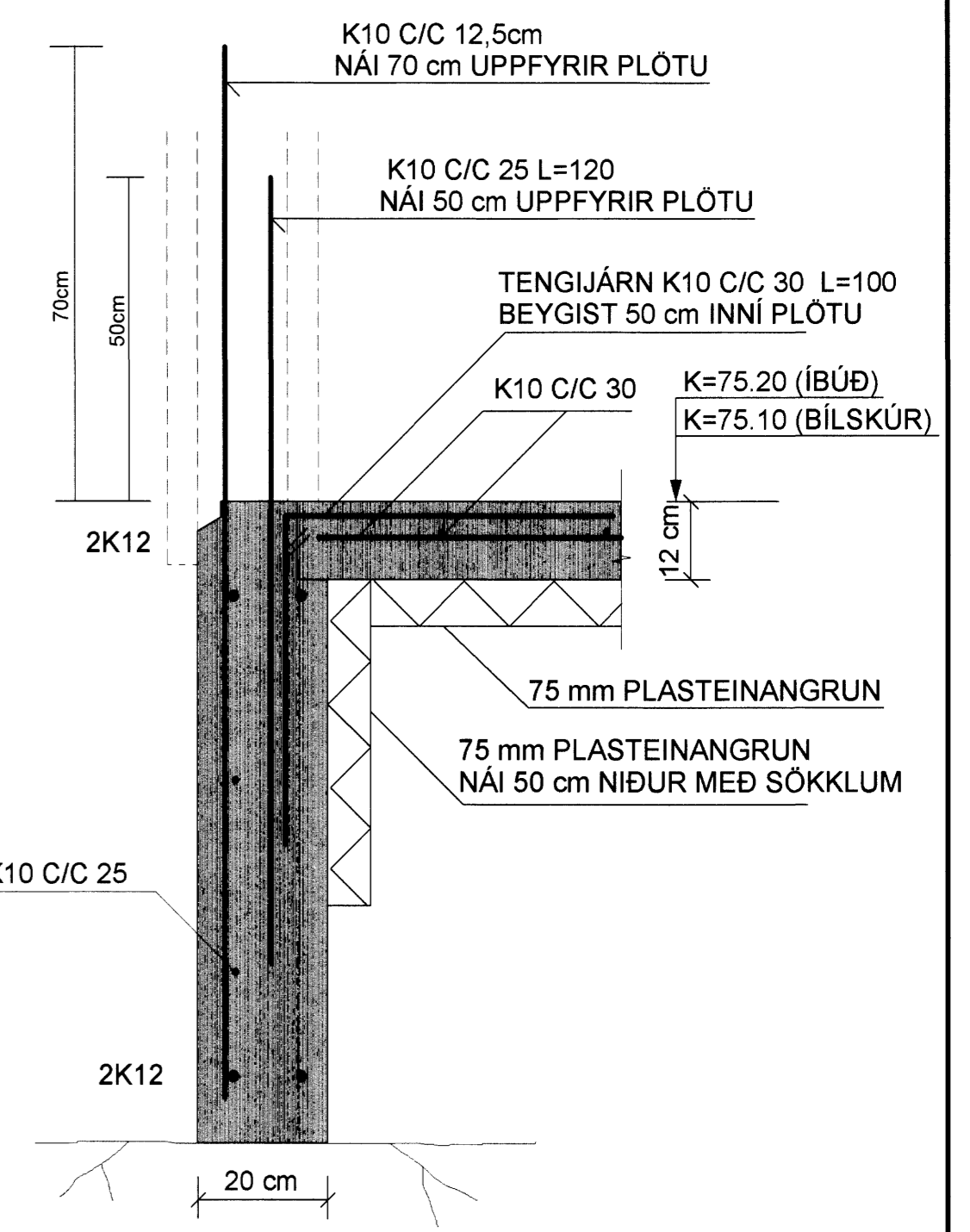

**SNID C-C MKV. 1:10**

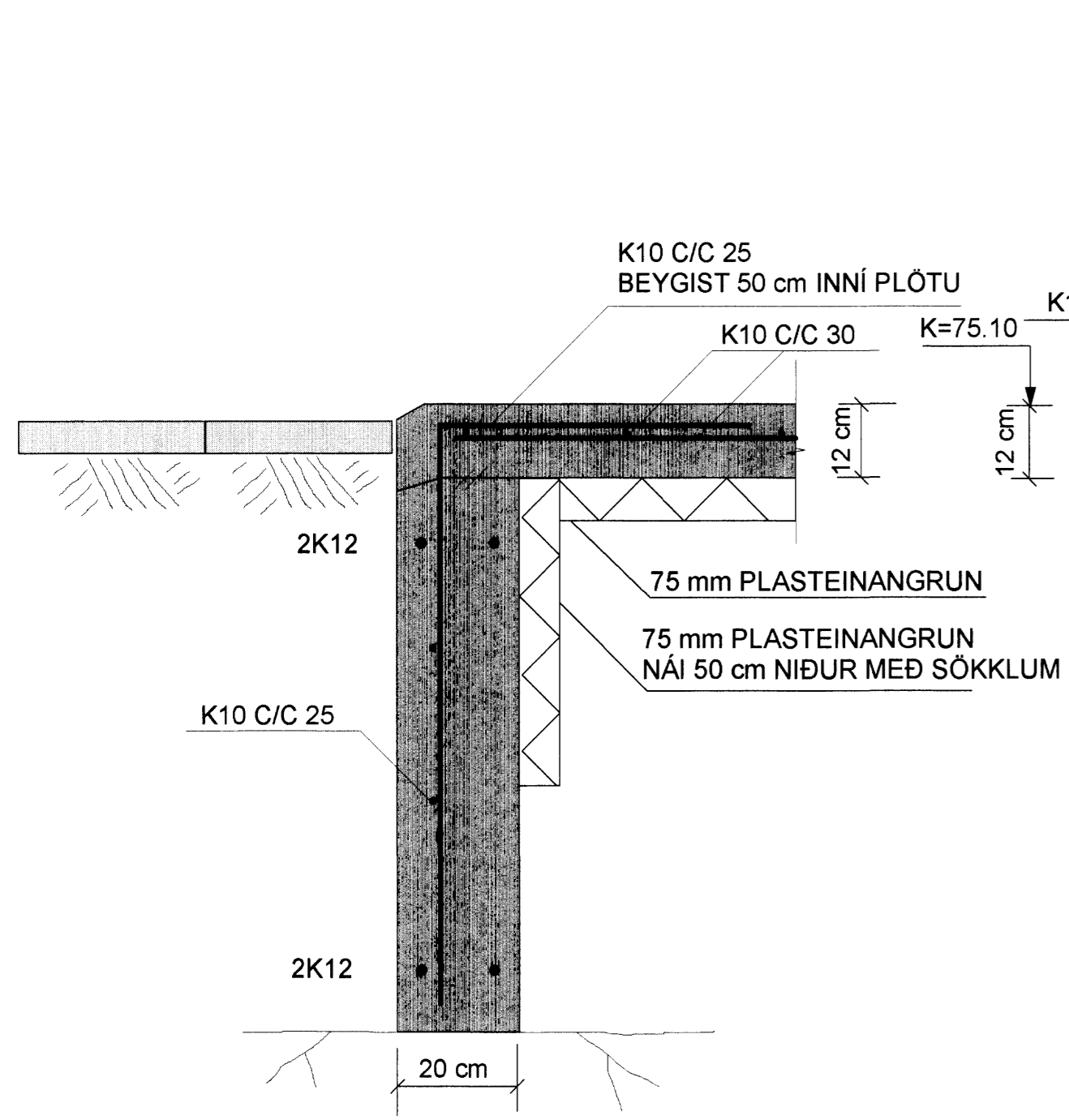

**SNID D-D MKV. 1:10**

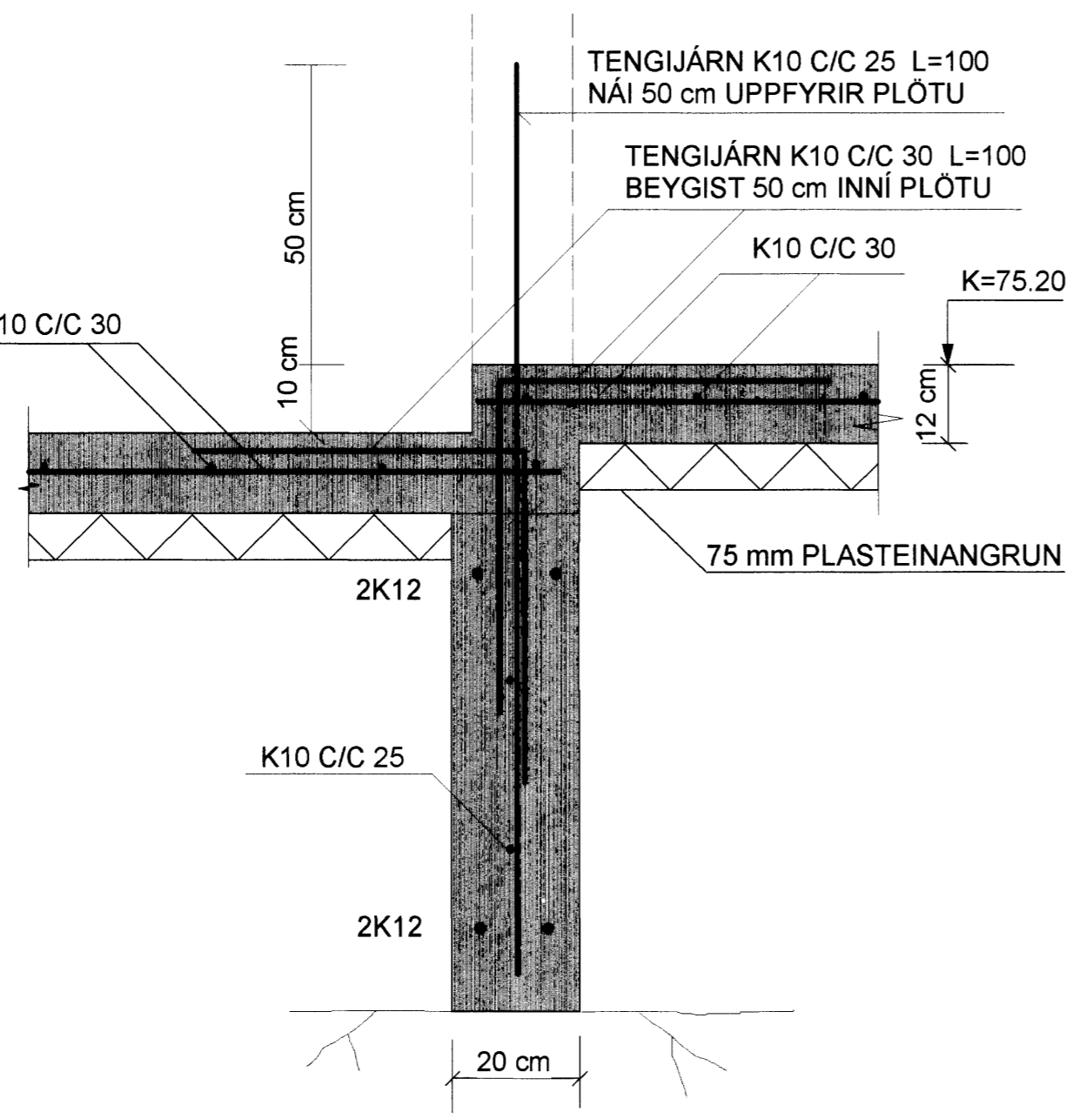

**SNID E-E MKV. 1:10**

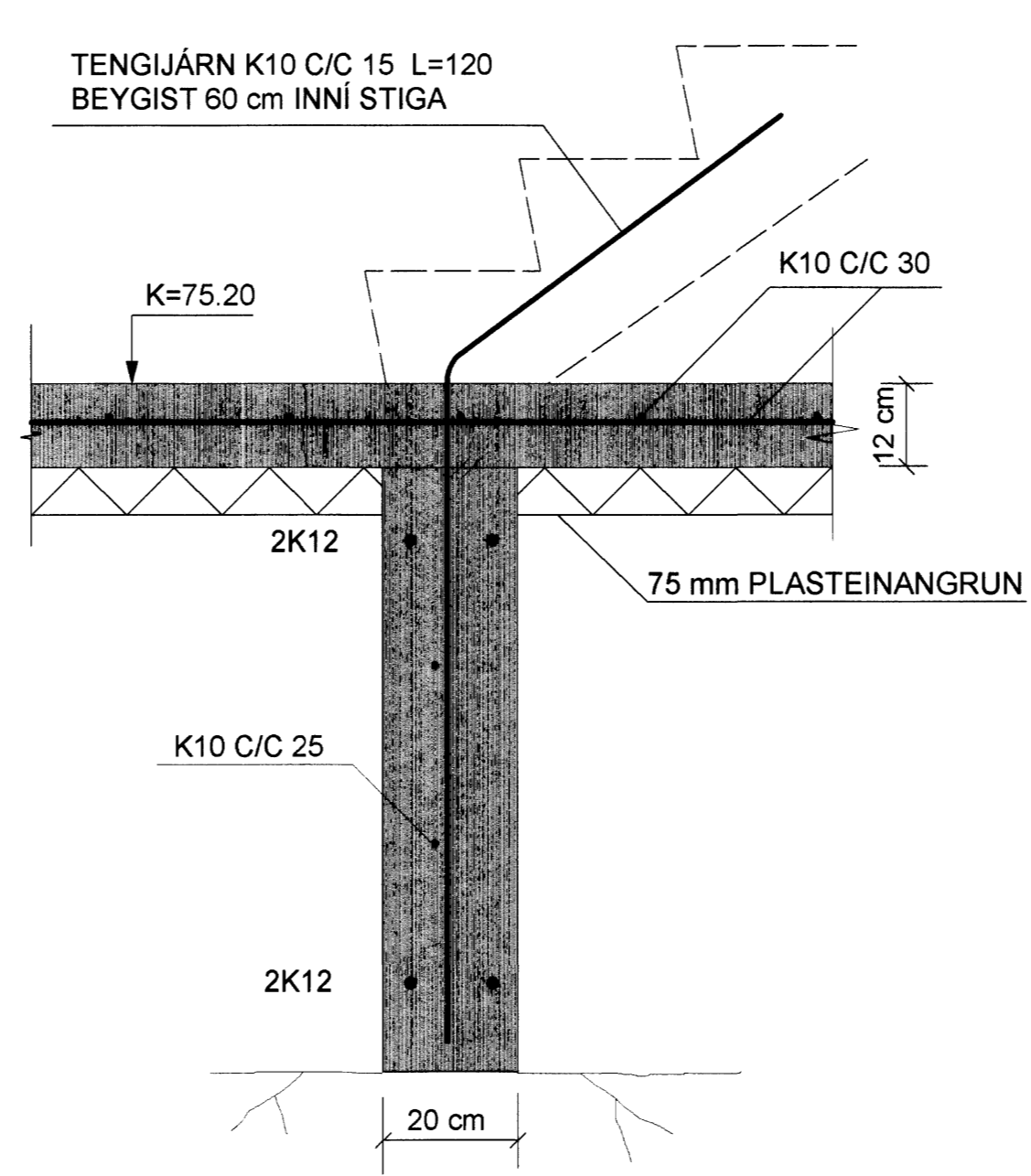

**SNID F-F MKV. 1:10**

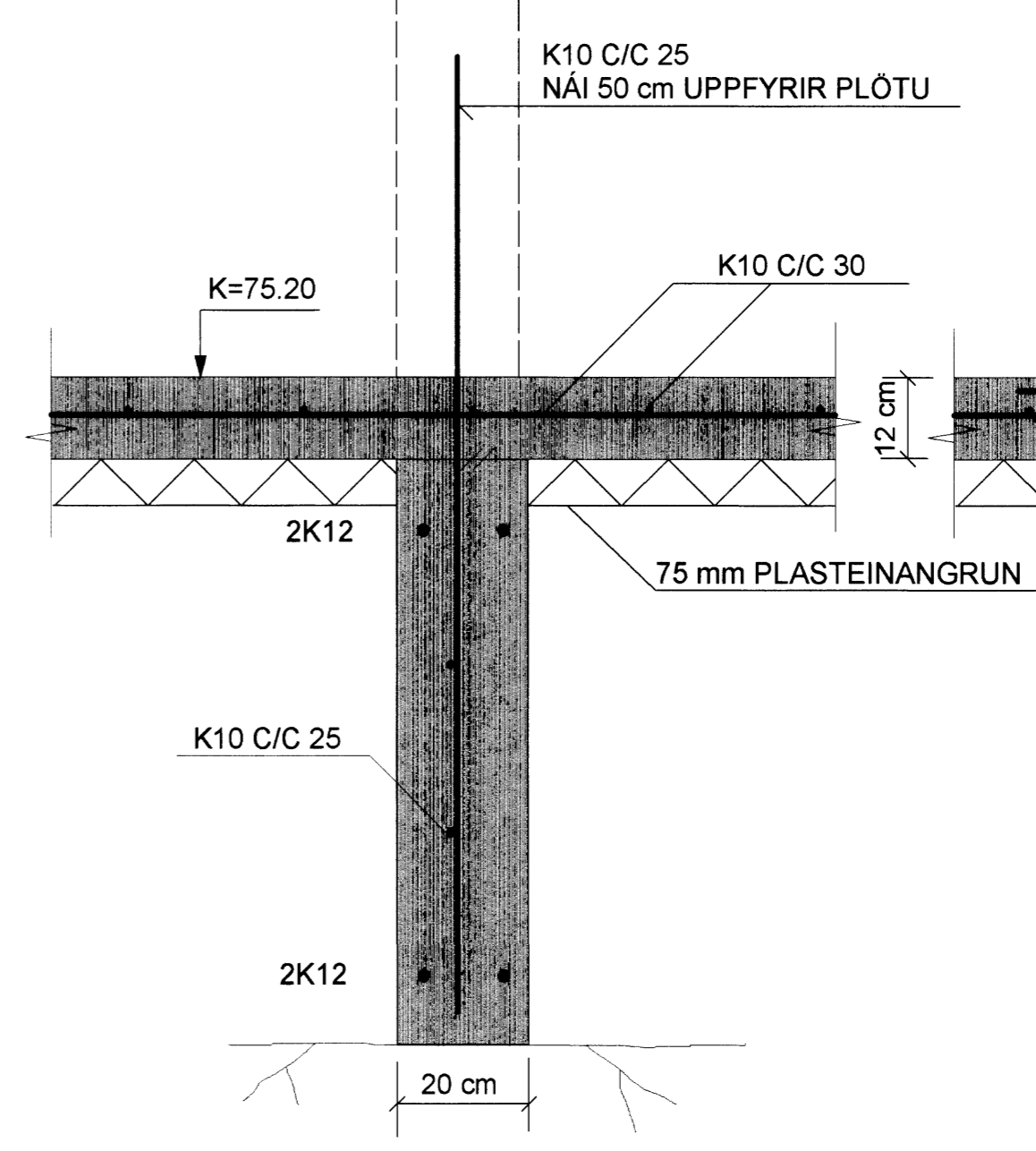

**SNID G-G MKV. 1:10**

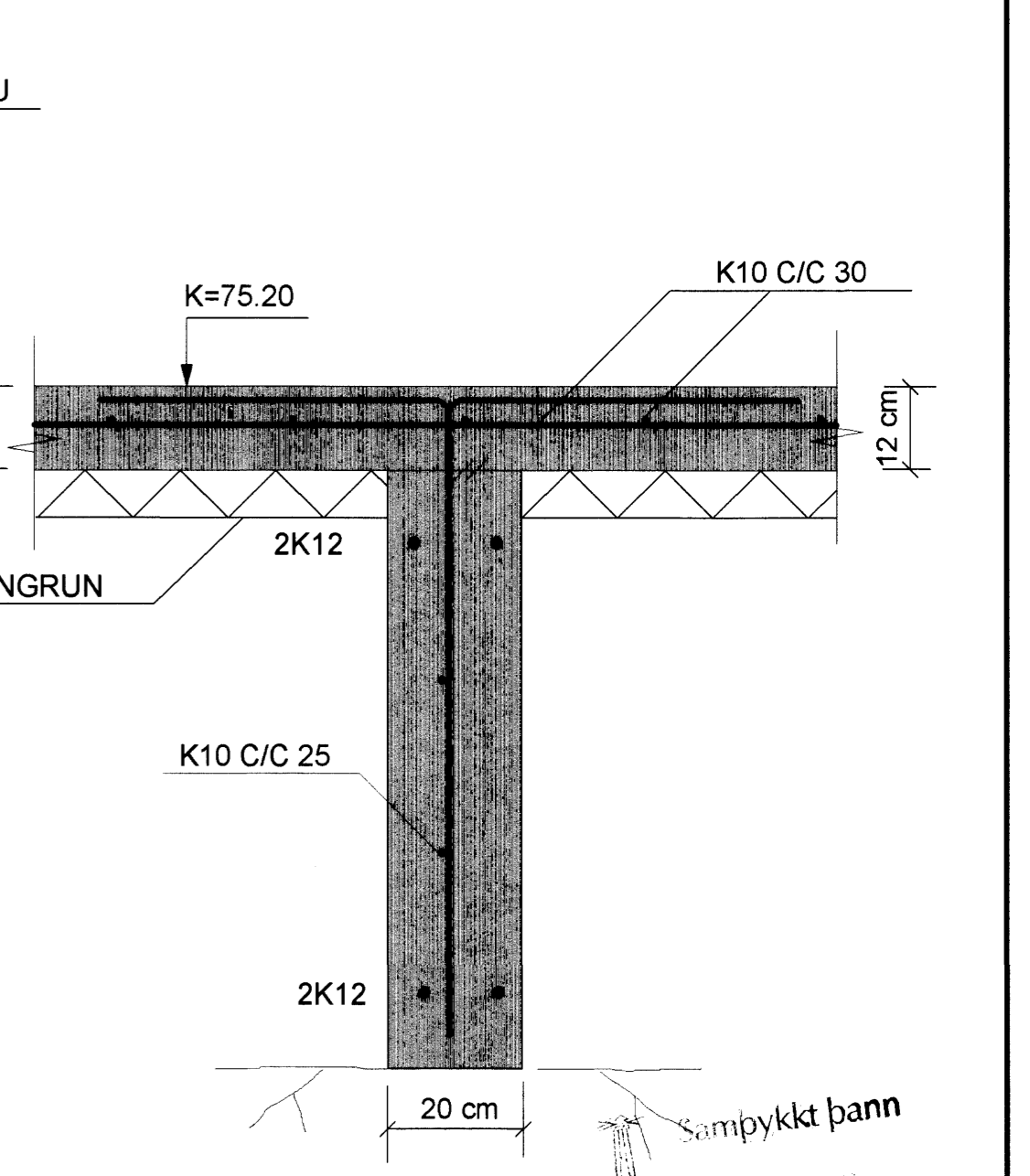

**SJÁ SKÝRINGAR Á TEIKNINGU NR. 1.02**

① BREYTT: 10.03.2007 (Sökkjar steyptr með hefðbundnum hætti í stað einangrunarmóta)

TEIKN.NR. 1.01	Tækniangur ehf. KT.450586-1889 Kirkjustétt 26, 113 Reykjavík Sími:564 22 44, Netf. tv@vortex.is
KVARDI: 1:50,1:10	
DAGS. JAN. 2007	
HANNAÐ: MG	VERKEFNI: FURUÁS 31, HAFNARFIRÐI
TEIKNÁÐ: MG	BURDARVIRKI: UNDIRSTÖÐUR, GRUNNMYND, SNID OG SKÝRINGAR
YFIRFARID: <i>Magnús Guðsson</i>	Undirskrift: <i>Abalinnuðar</i>