

LANGJÄRN 4 K16

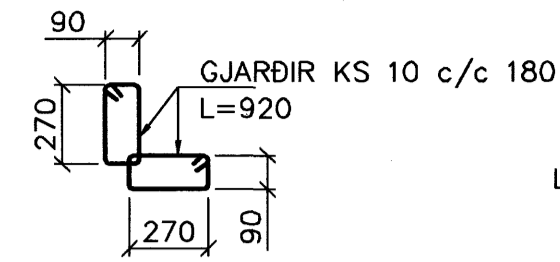

LANGJÄRN 4 K12

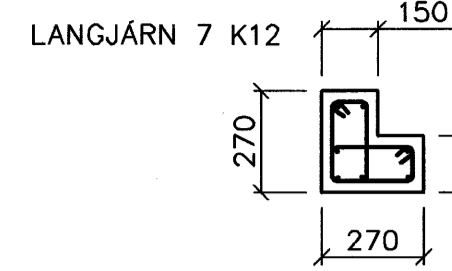
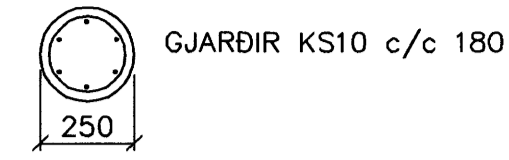
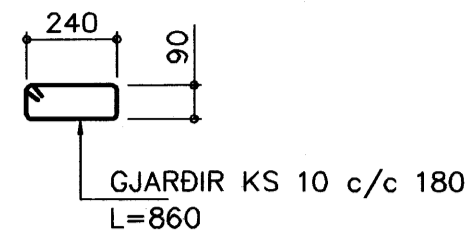
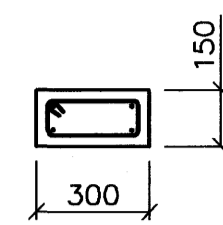

SÚLA S1 1:20

SÚLA S2 1:20

SÚLA S3 1:20

Sampykkt þann
08 AUG. 2007
Byggingufráunirinn í Hafnarfirði
F.h. Stigurbjartur Halldórsson

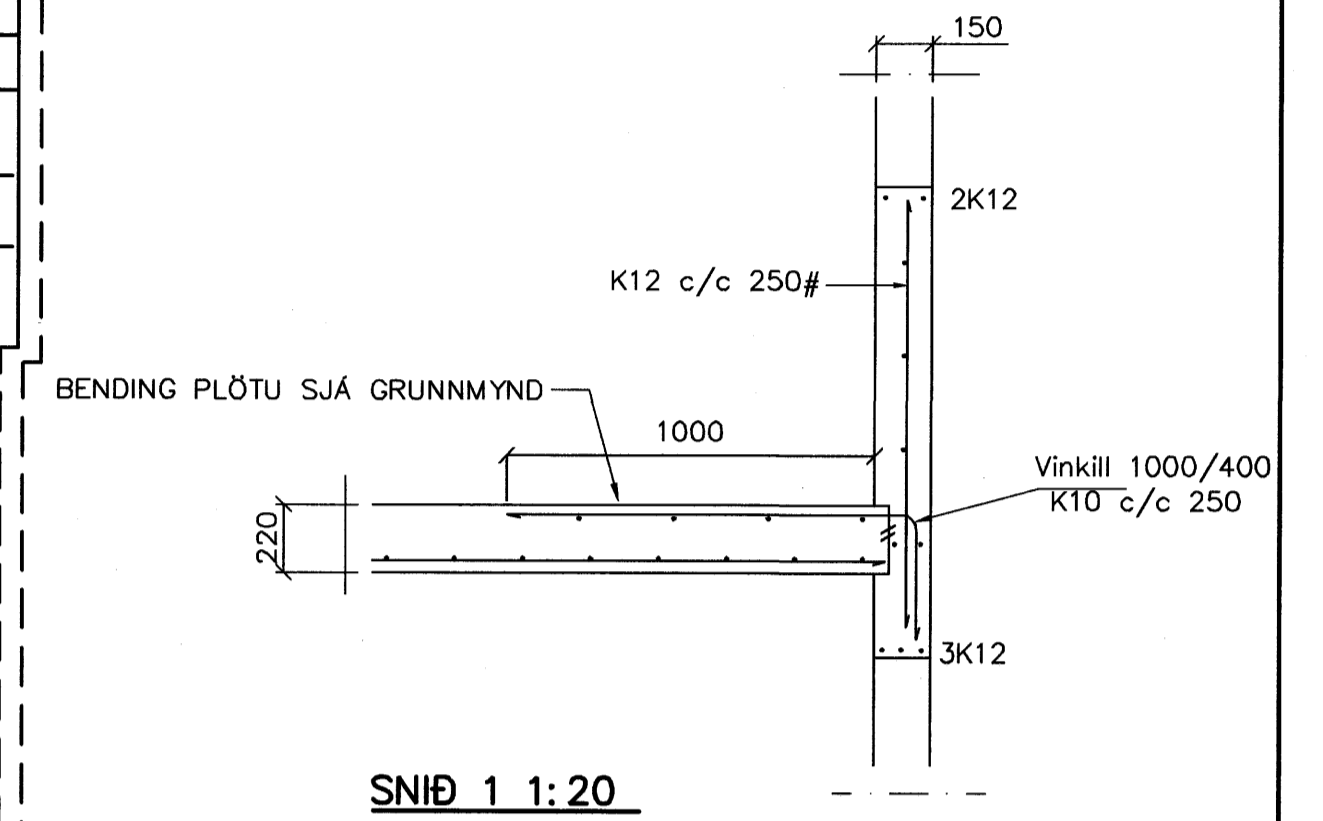
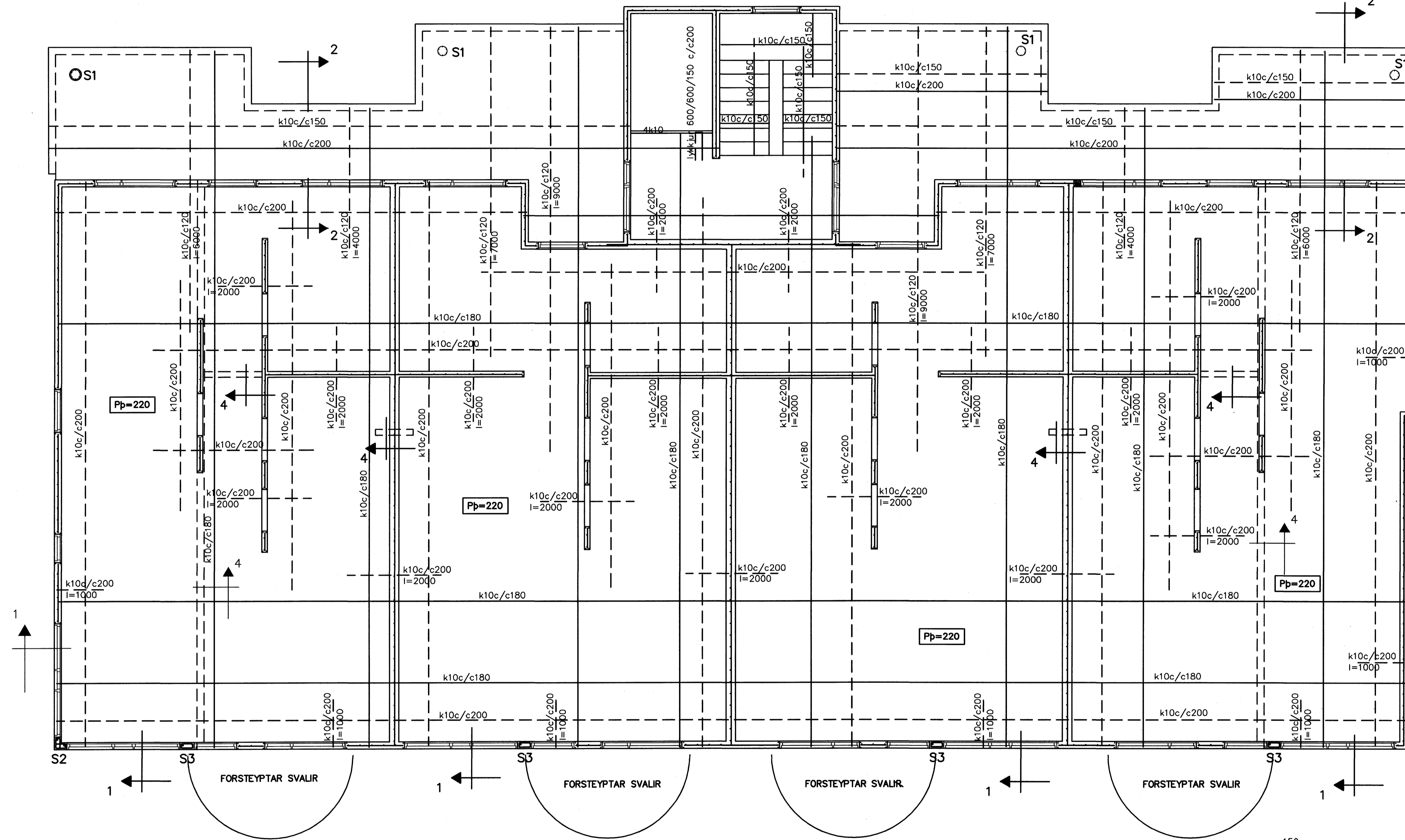

SKÝRINGAR
ALMENNAR SKÝRINGAR SJÁ BL. 1-01
STEYPA S-250, SEMENTINNHALD = 300kg/M
STEYPUHULA Í ÖTVEGGJUM = 30mm
STEYPUHULA Í PLÖTU = 20mm
BENDISTÁL Ks410

BENDING VEGGJA
Ötveggjar einföld grind í miðjum vegg
Lörétt K12 c/c 250
Lörétt K12 c/c 250
Miðliveggjar einföld grind í miðjum vegg
K12 c/c 250#

Br.	Dags.	Eðli breytinga	Sign

BREKKUÁS 5 HAFNARFIRÐI

BENDING VEGGJA 2 HÆÐAR
BENDING PLÖTU YFIR 2 HÆÐ

MKV. 1:50 1:20
DAGS. JÚNÍ 2007
VERK NR. 2704
TEIKN. NR. 1-03
HANNAD SIG. ÞORLEIFSS. KT. 241148-3009
TEIKNAD YFIRFARID

TÆKNIRJÓNUSTA SIGURDAR ÞORLEIFSSONAR ehf
STRANDGÖTU 11 220 HAFNARFIRÐI
SÍMI 555-4255 FAX 565-2875
E-mail tesh@simnet.is
kt: 440693-2539

GRUNNMYND 1:50

