

JÄRNBENT STEYPA

Forsteyptar loftaplötur (filegran)

Yfirlitsmynd 1:50

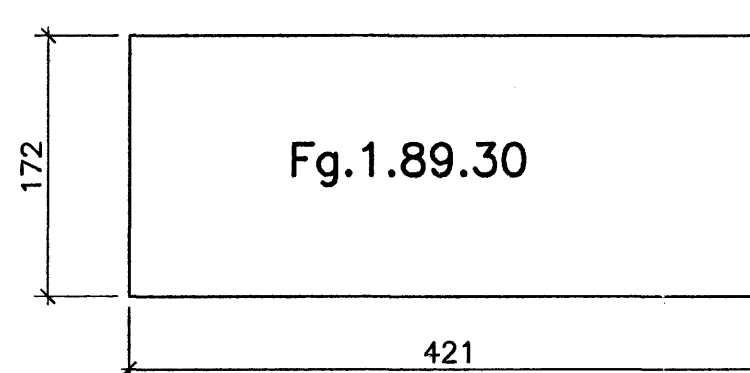
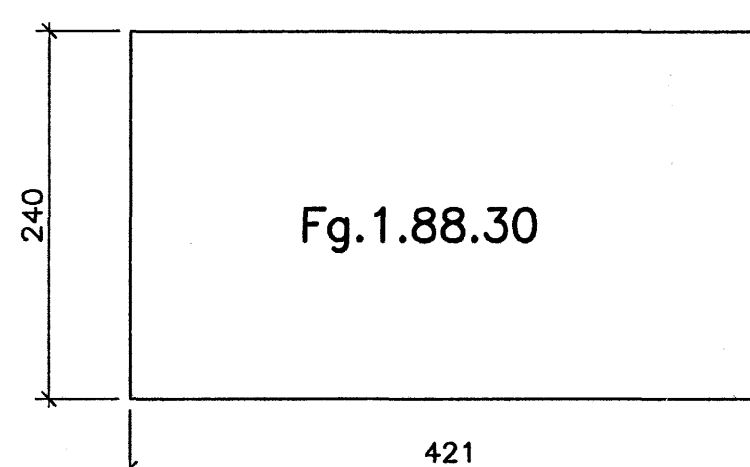
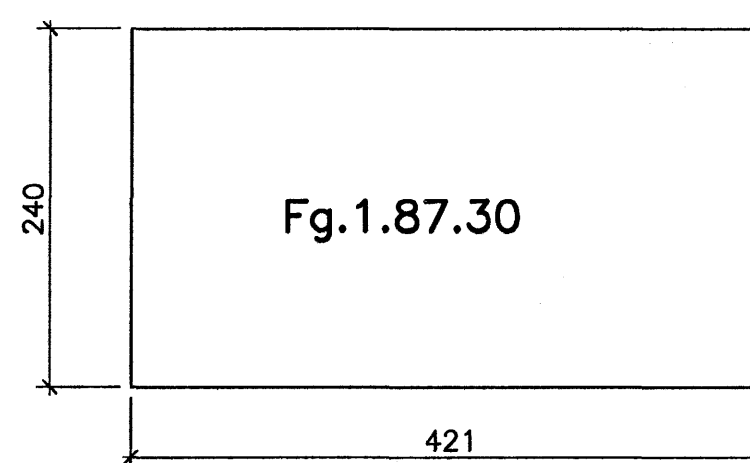
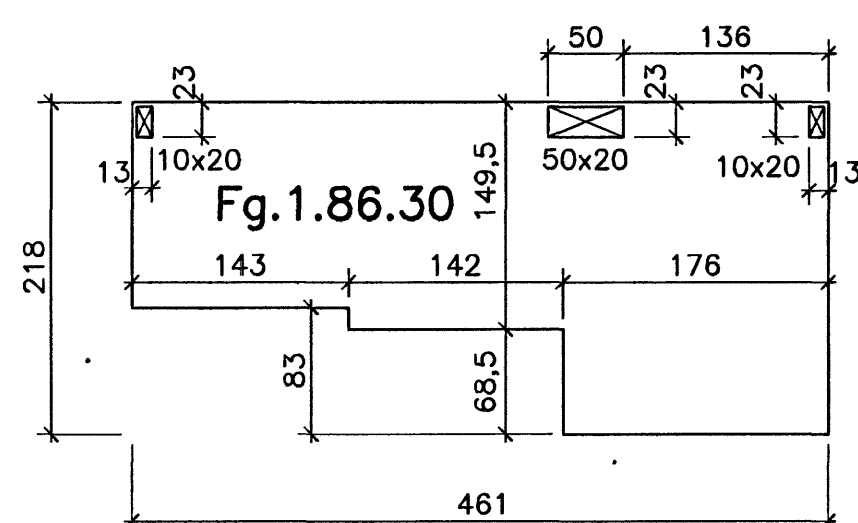
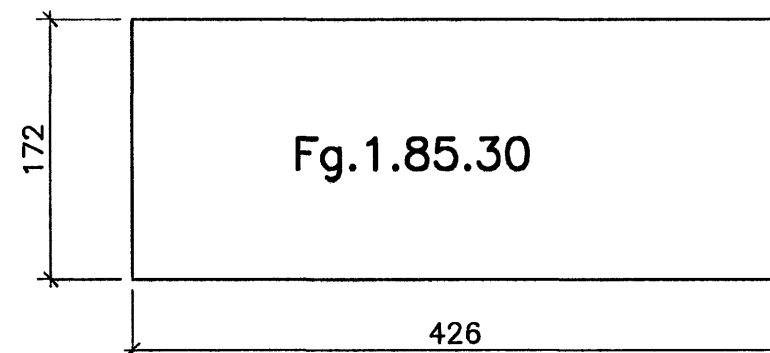
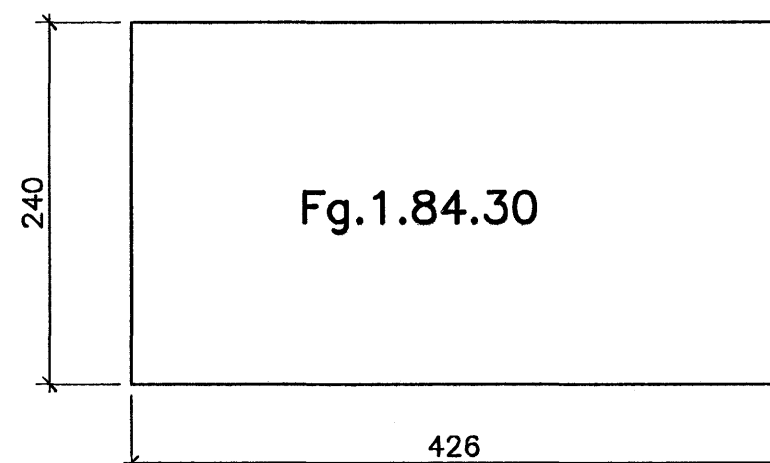
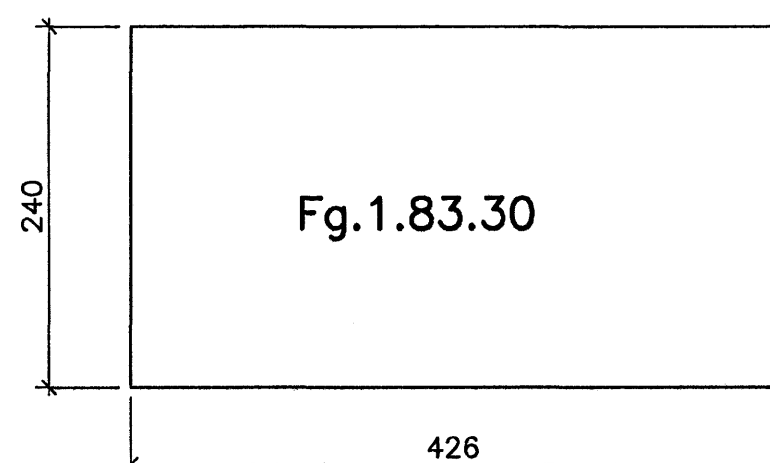
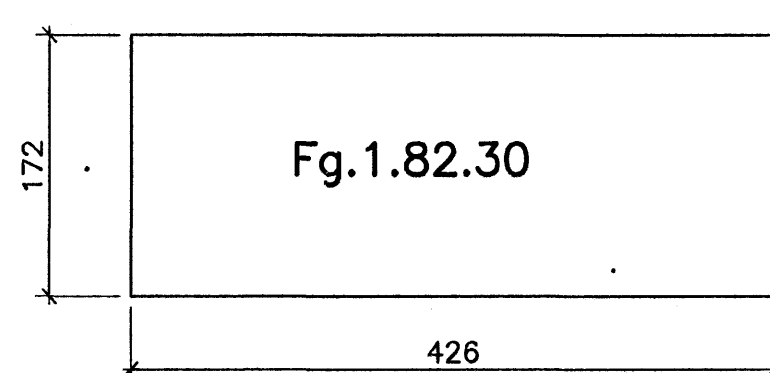
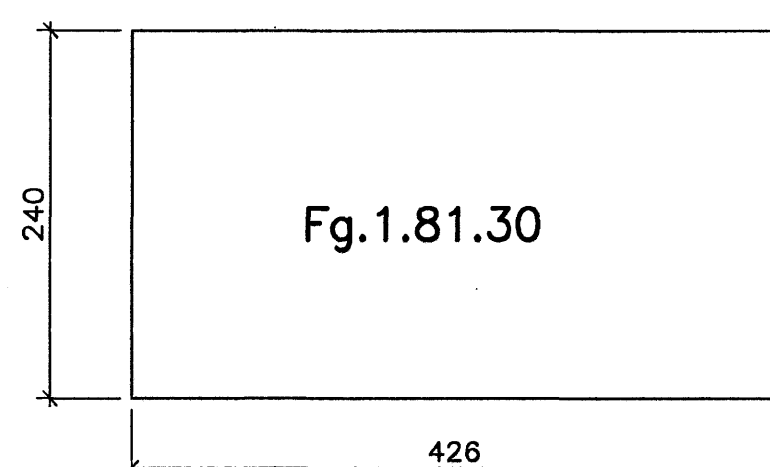
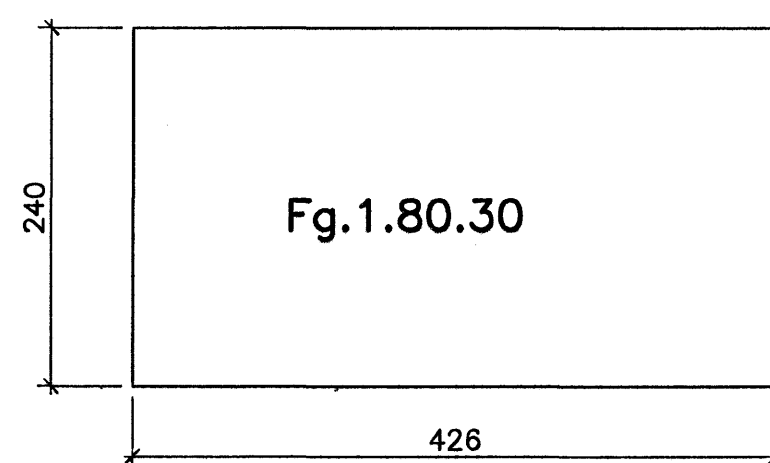
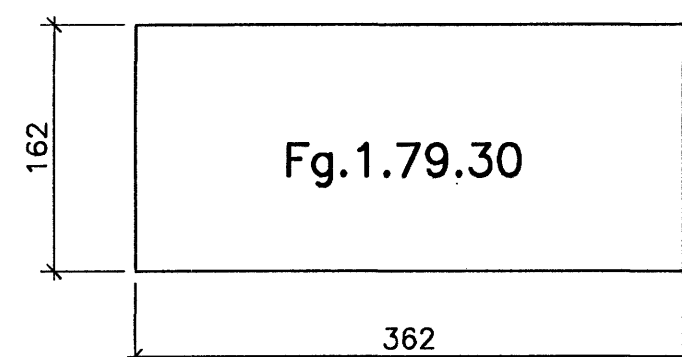
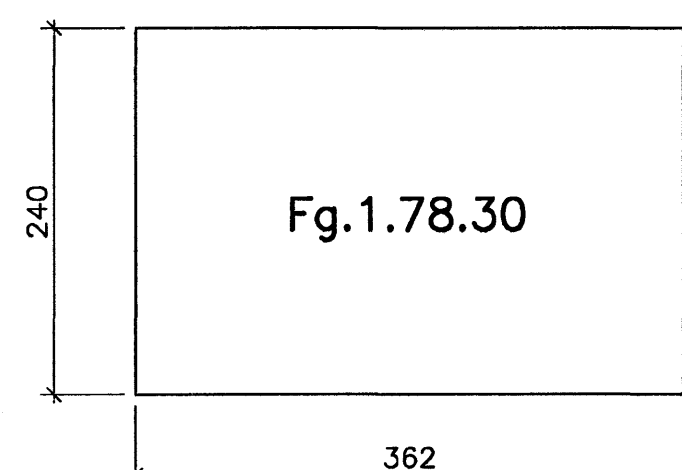
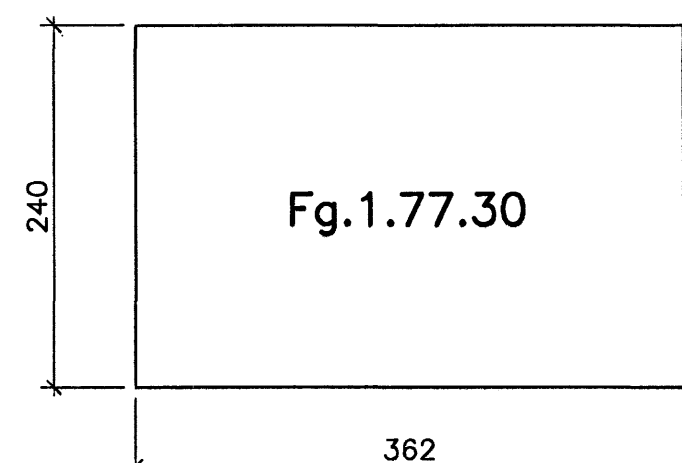
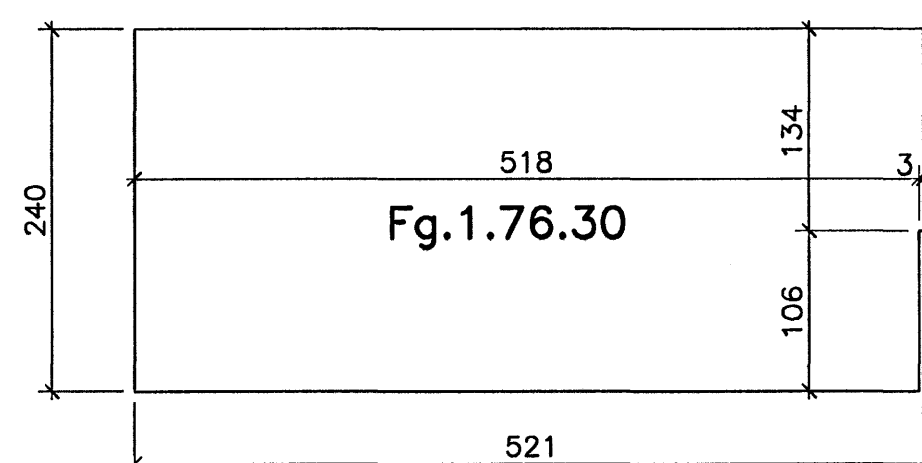
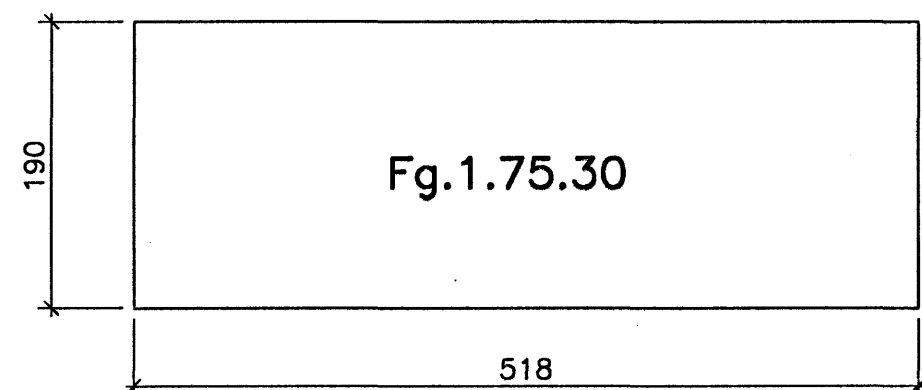
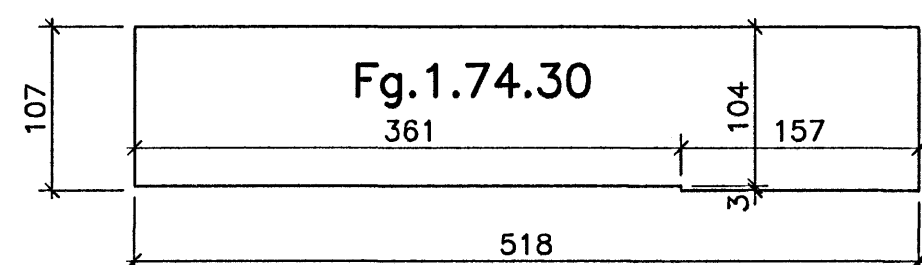
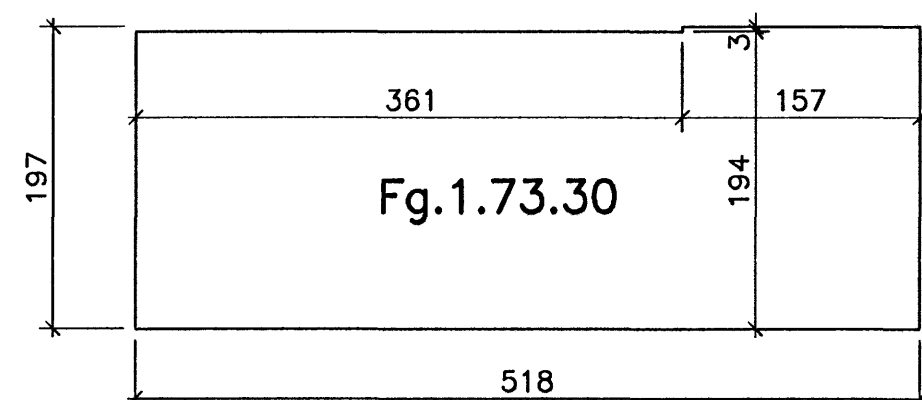
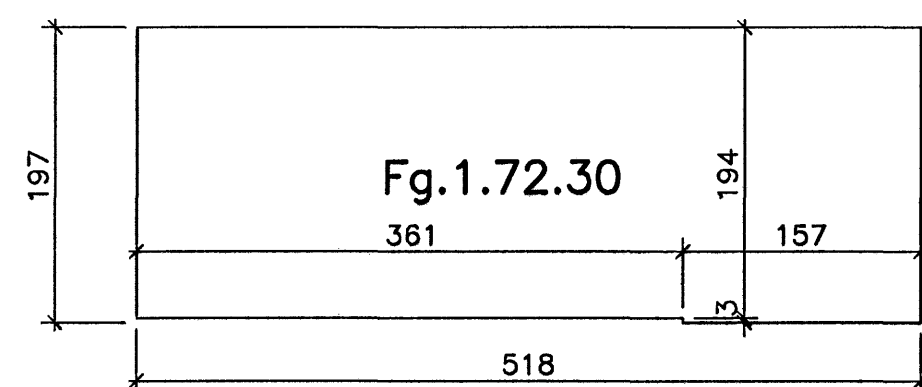

SKÝRINGAR:

Allar loftaplötur eru forsteyptar og forspenntar 8 cm þykkar filegranplötur. Tengistigar (filegran-trager) eru 14 cm háir með 90 cm bill. Forspennukaplar eru spennir í 1050 MPa og eru með 30 cm millibili.

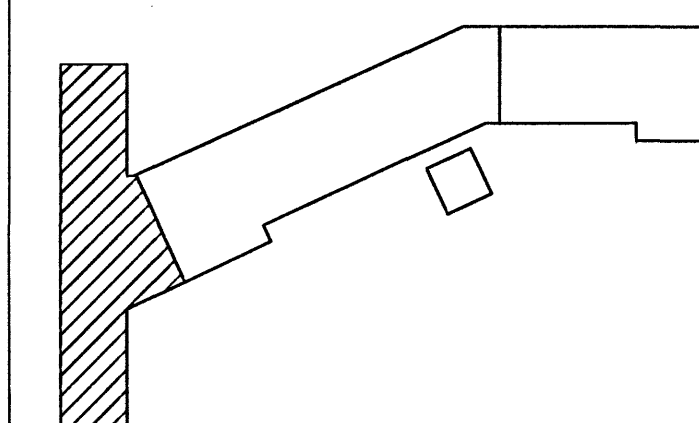

Breytingar:

A: K.S.G. Breytt 22. júlí 2005

Breyting á Fg.1.80.30, Fg.1.81.30, Fg.1.82.30, Fg.1.83.30, Fg.1.84.30 og Fg.1.85.30.

Fg.1.87.30, Fg.1.88.30 og Fg.1.89.30. eru nýjar.

Kennisnið í filegranplötur 1:20

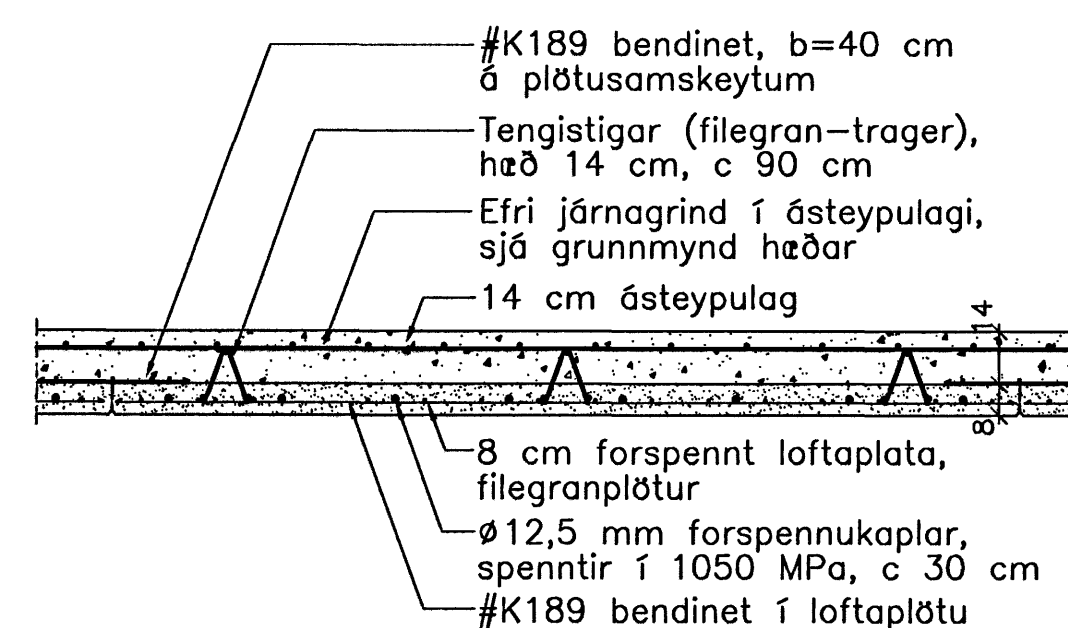

Vífill Oddsson
101237 3629

TEIKNISTOFAN
ÓDINSTORGI

Verkefni: Lækjargata 30 Hafnarfirði

Heiti: Järnbent steypa: Forsteyptar loftaplötur (filegranplötur)

Hönnun: Vífill Oddsson verkfræðingur

VÍFILL ODDSSON
kt. 101237-3629

VERKFRÆÐINGUR
FVFI - FRV

ÓDINGSGÖTU 7 REYKJAVÍK

SÍMI: 510-2200
FAX: 510-2201

M. 1:50 og 1:20

R. V.O./K.S.G.

T. K.S.G.

Dags. des. 2004 Nr.969-1-12A

