

G.1
3.stk.

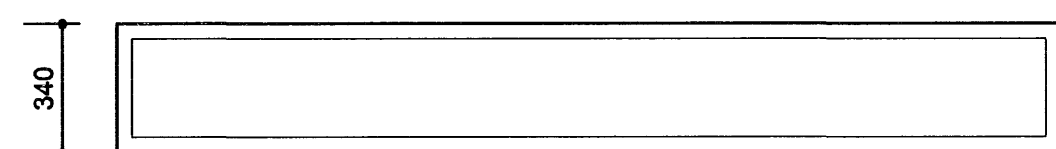

G.2
1.stk.

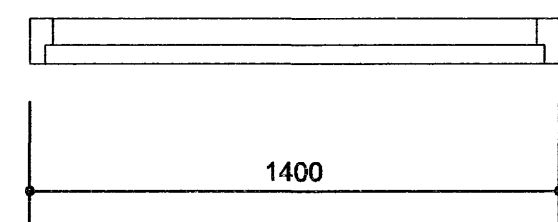
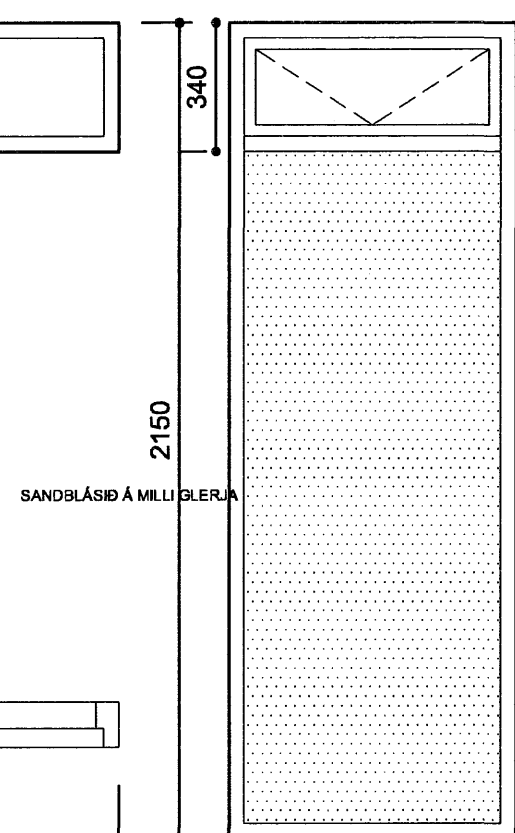
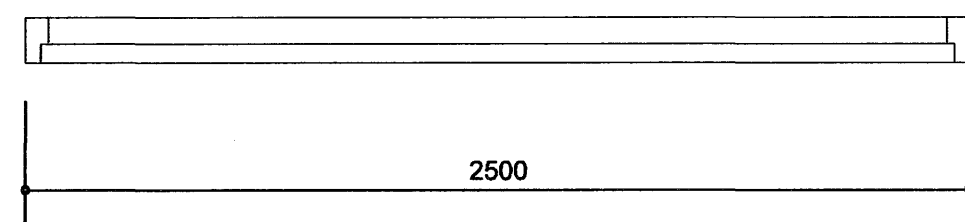

G.3
1.stk. GLUGGI BADHERBERGI NEDRI HÆÐ

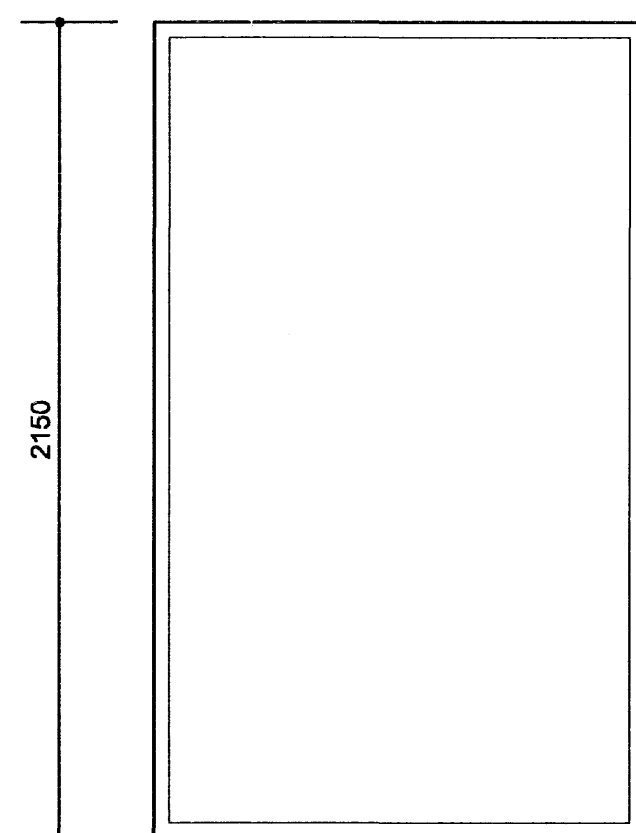
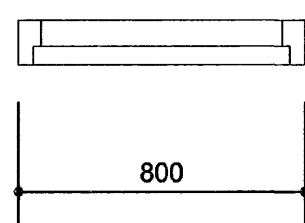

G.4
1.stk.

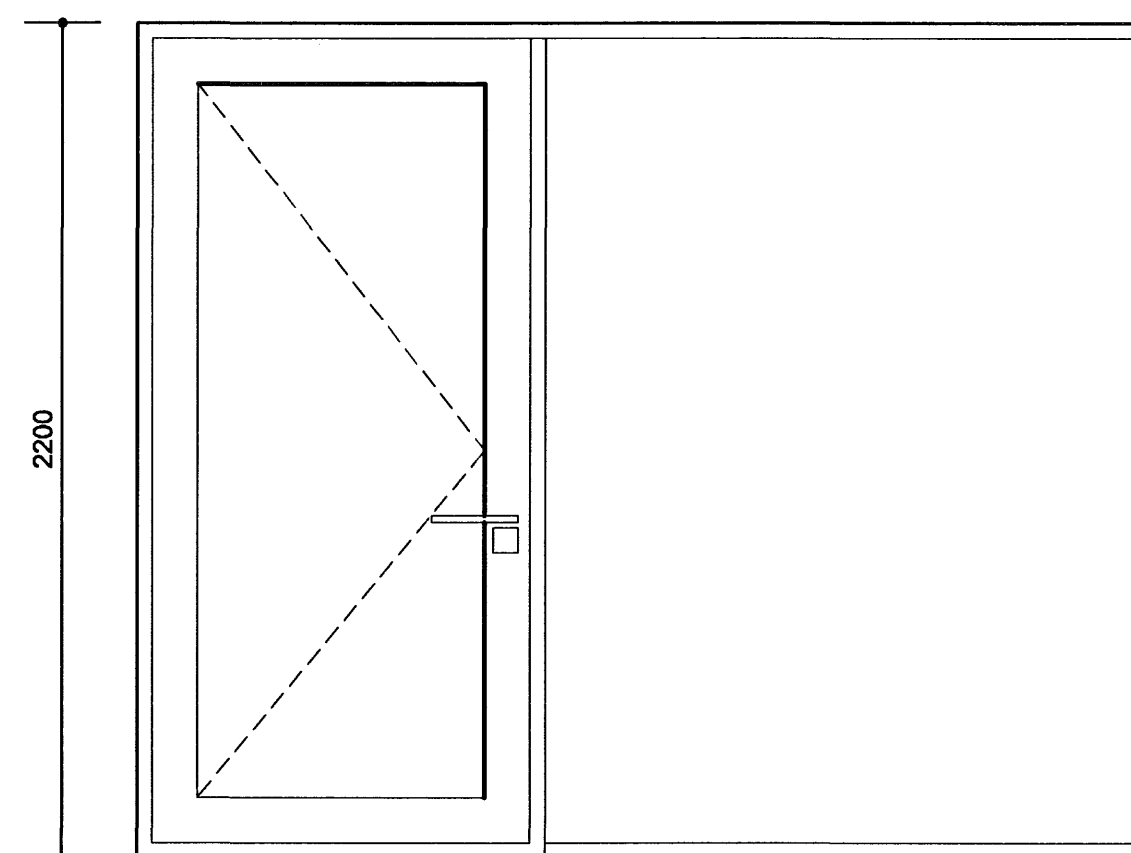
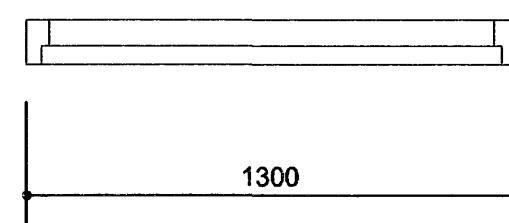

G.5
1.stk. HURÐ GLUGGI AÐALINNGANGUR

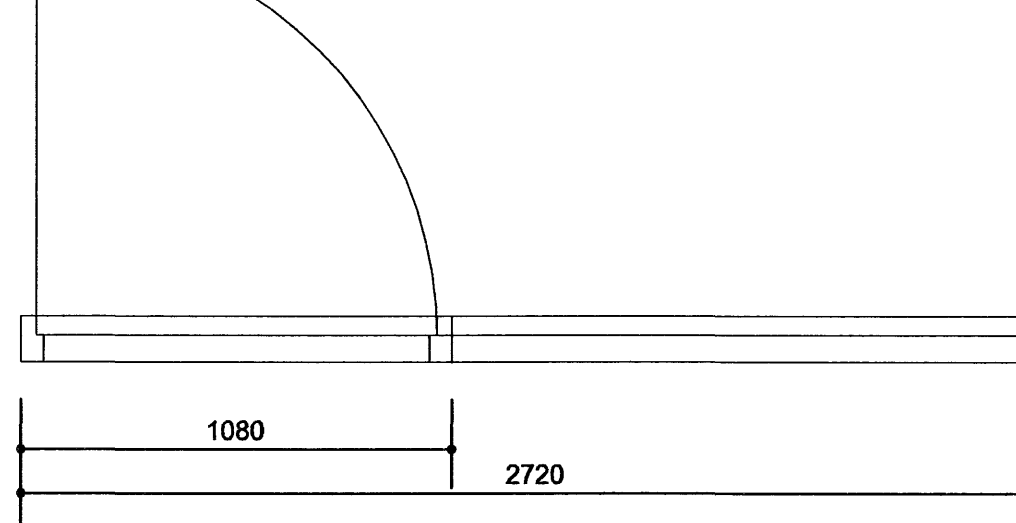

ÖLL GLUGGAMÁL Á TEIKNINGUM ERU OPMÁL.
ALLIR GLUGGAR ÁLKLEDDIR TIMBURGLUGGAR
ALLIR GLUGGAR OG HURÐIR SKULU VERA ÚR HVÍTU.
BÍLSKÚRSHURÐ PLAST EÐA ÁLKLEDD Í HVÍTU.
GLUGGAFJÖLDI SKAL YFIRFARIN AF VERKTAKA AÐUR EN SMÍÐI HEFST.

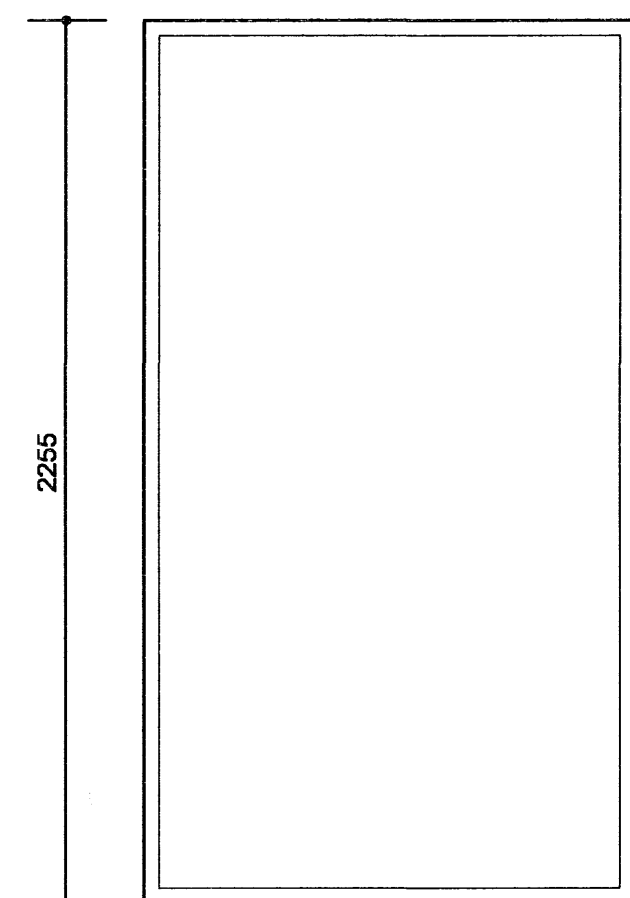

G.6
1.stk.

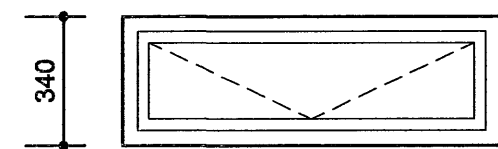
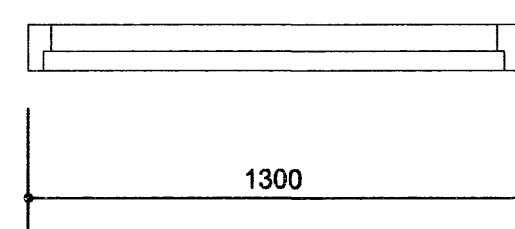

G.7
1.stk.

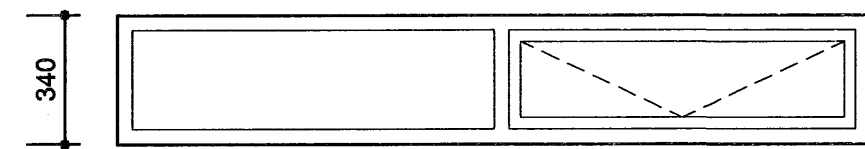
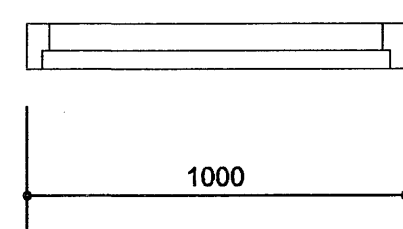

G.8
1.stk.

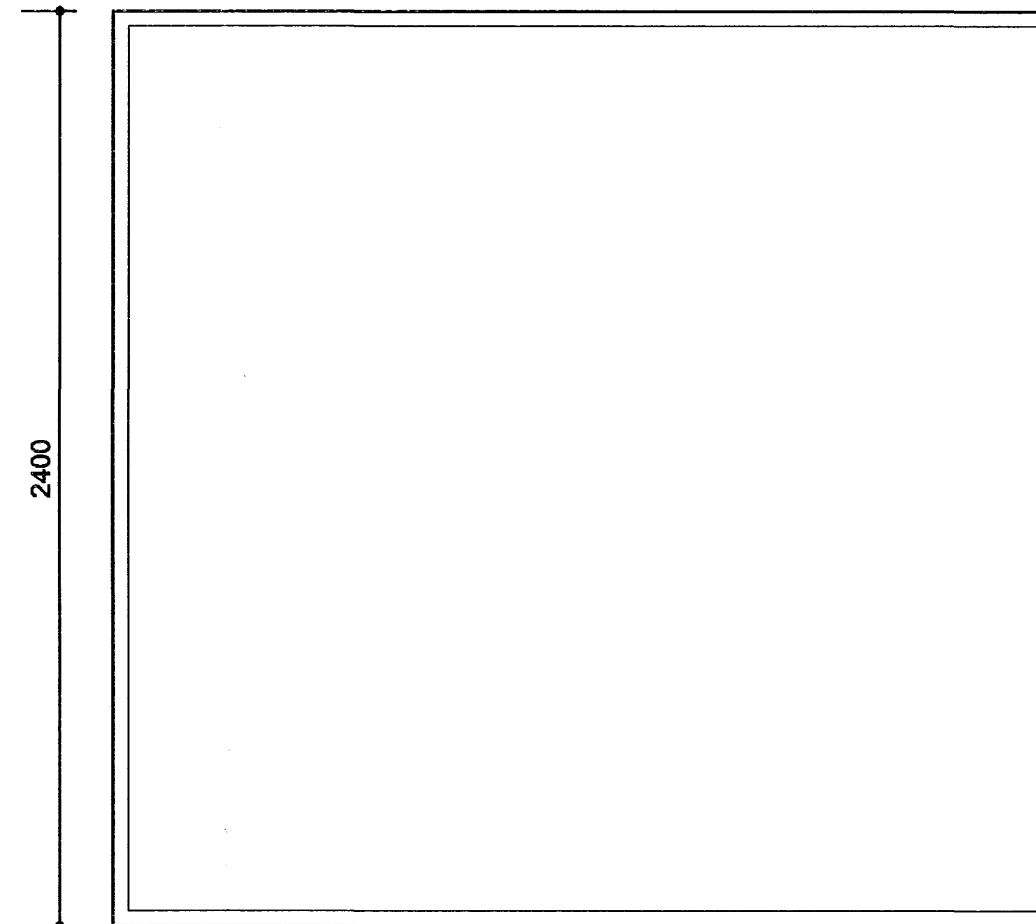
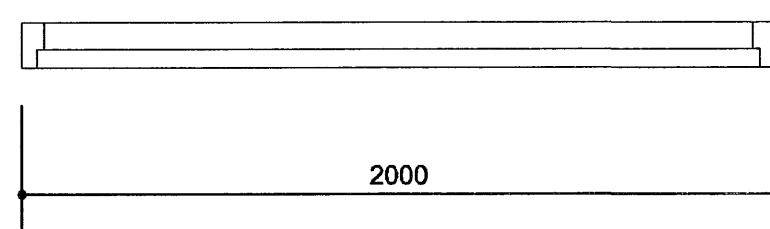

G.9
1.stk.

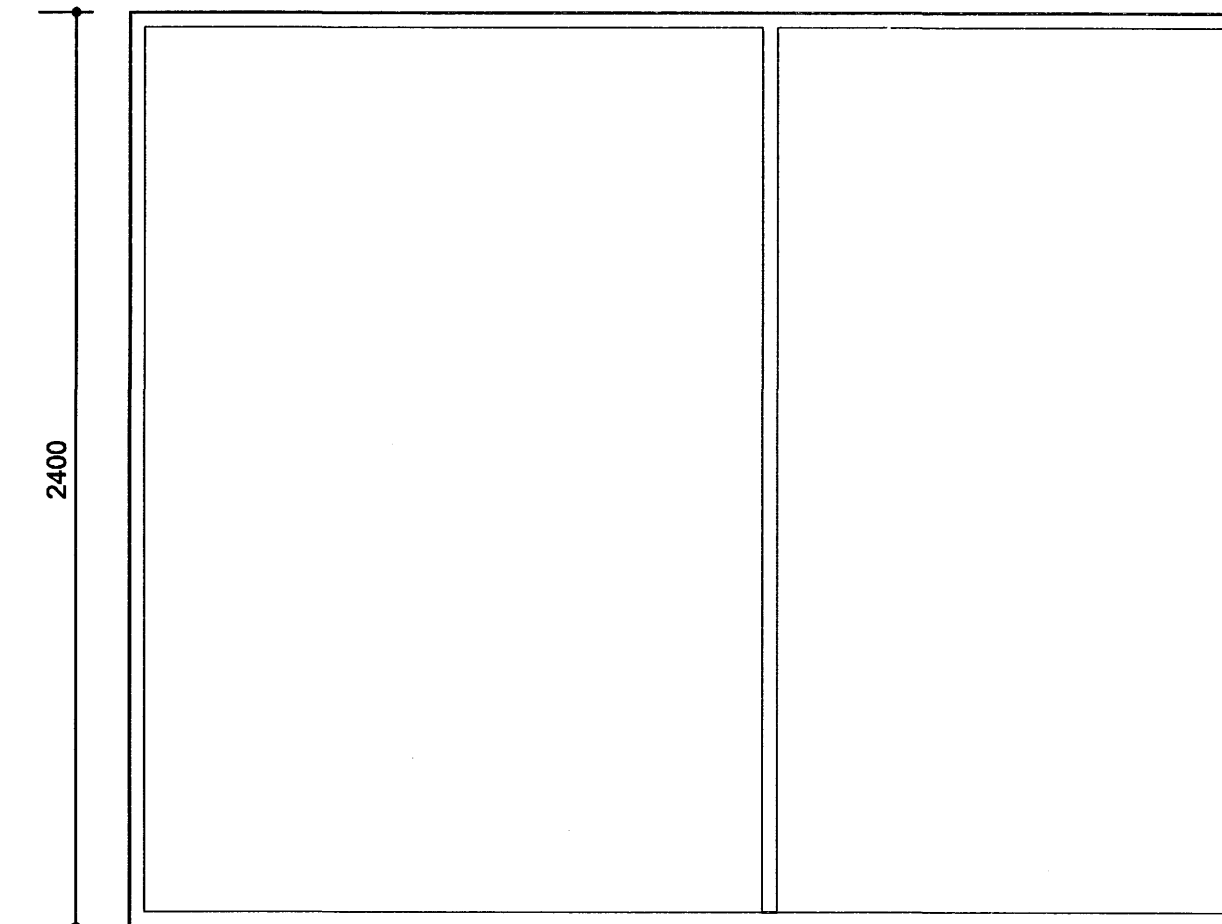
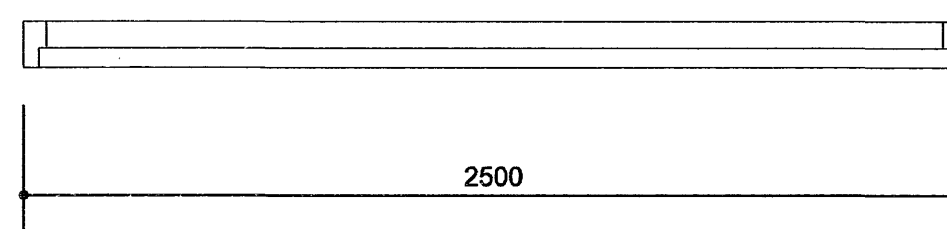

G.10
1.stk.

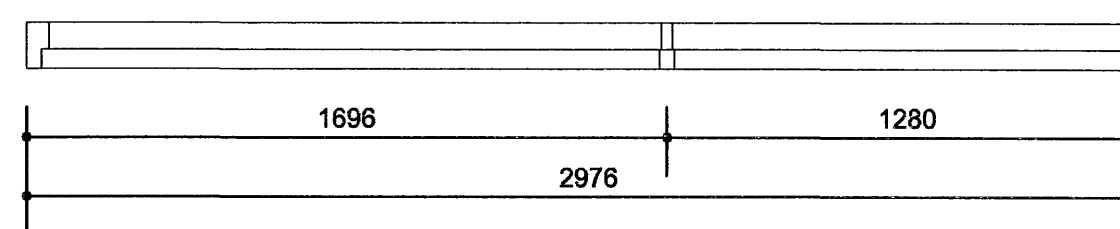

Samþykkt þann
09 JULI 2007

Byggingulfrúnn í Hafnarfirði
F.h.Sigurbjartur Halldórsson

ATELIER ARKITEKTA EHF.
Björn Skaptason, arkitekt FAI
Suðurlandsbraut 6, sími 5666680
kt.580105-1140 fax 5666640
gsm 6968977
netfang. atelier@mmedia.is



HLÍÐARÁS 22	SÉRTEIKNINGAR
HAFNARFJÖRÐUR	
mkv.1:50	tnr-10-15
dags.DESEMBER- 2006	

Öll mál staðfaerist áður en framkvæmdir hefjast,
ósamræmi í teikningum tilkynnist arkitekt strax,
öli valfaatni skal bera undir arkitekt.