

G3, G4  
X2

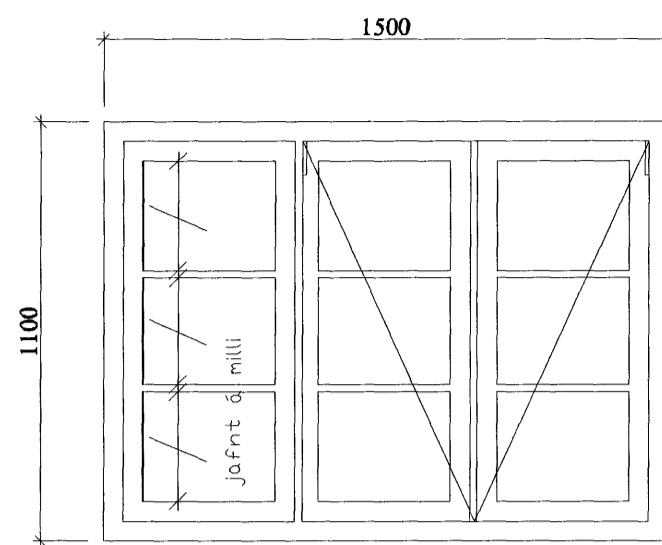

G5, G6  
X2

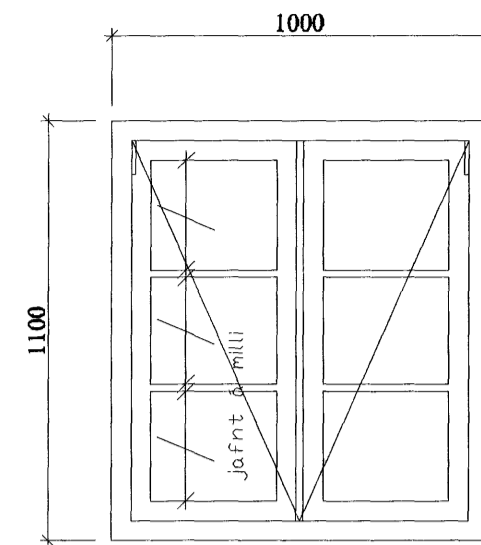

G1, G2, G7, G8, G9, G12, G13 og G14  
X8

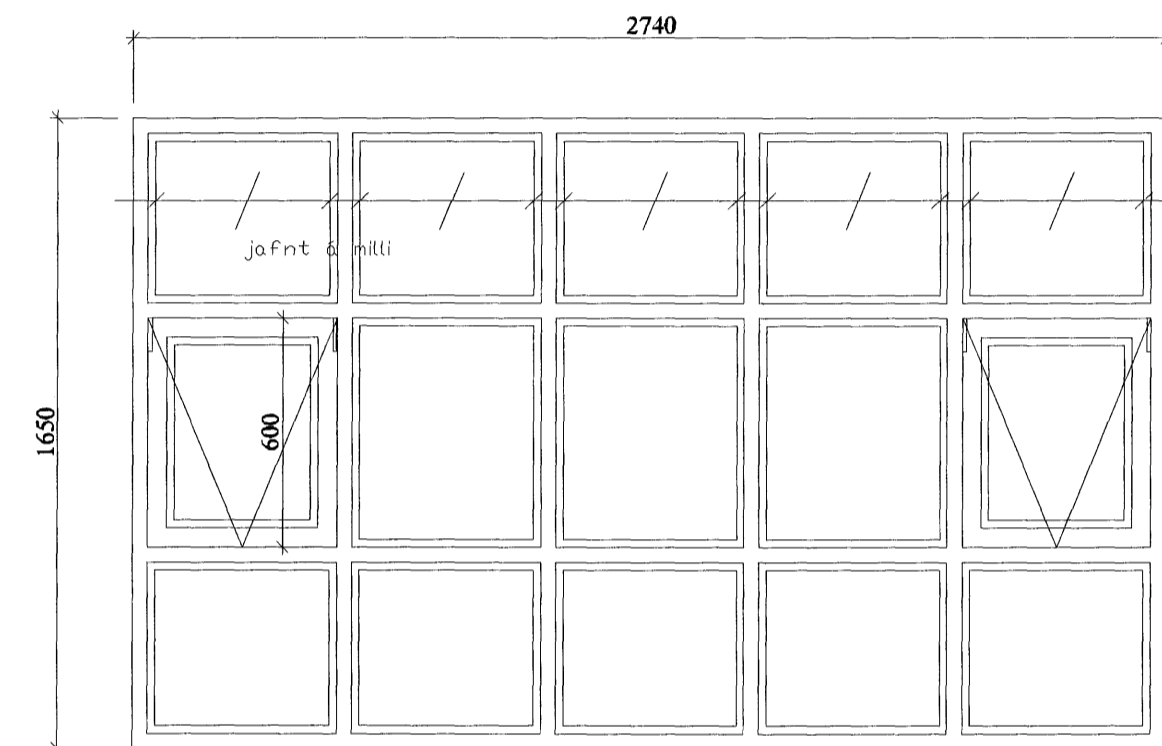

G12, G11  
X2

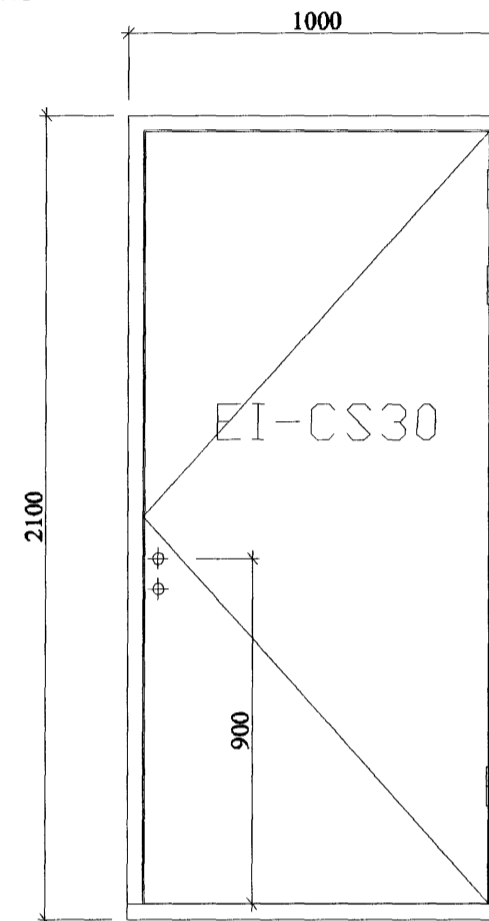

H3 og H16  
X2

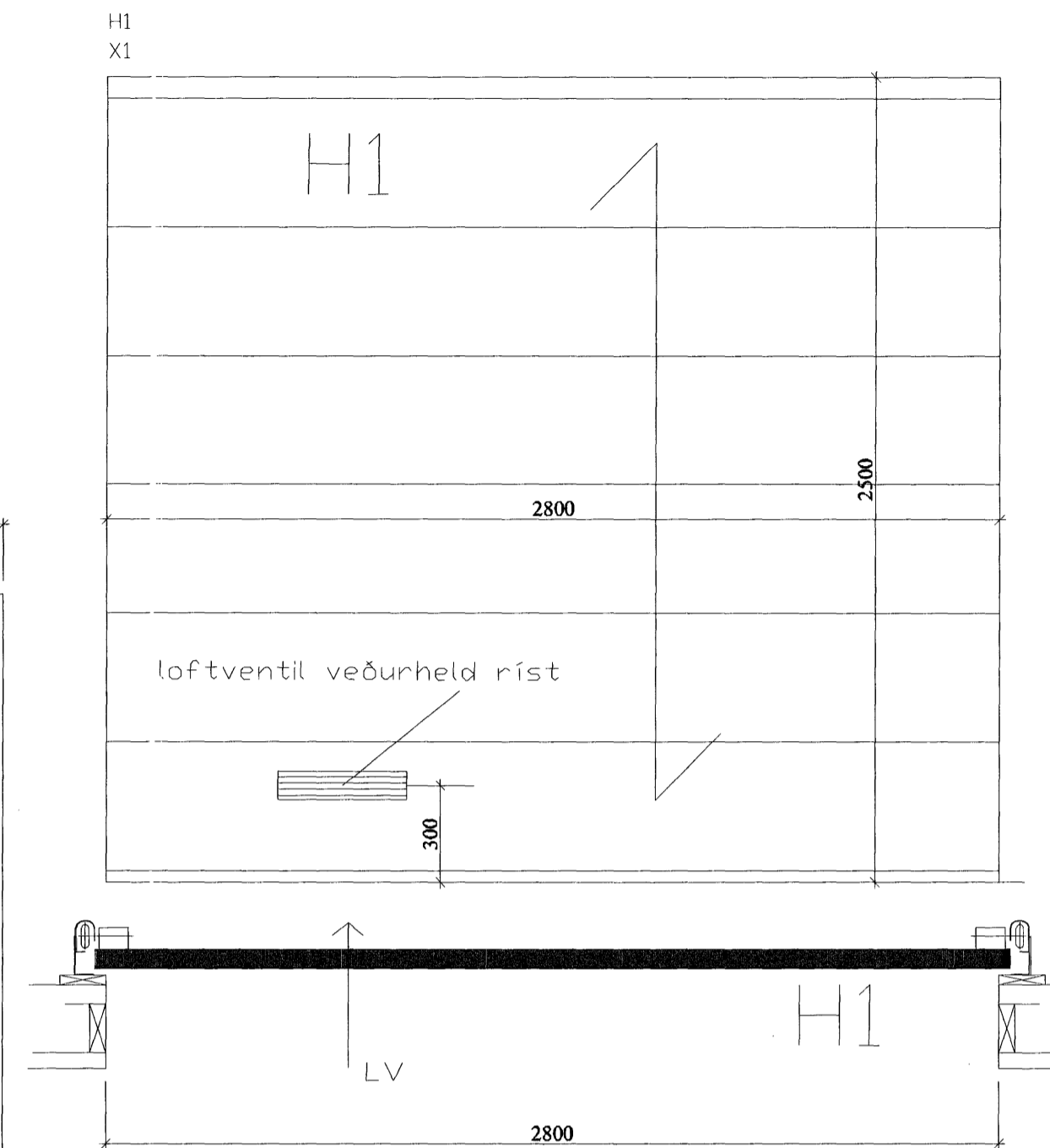

Mæla skal upp á staðnum áður en smíði hefst  
ATH: Öll mál er op-mál ekki smíða-mál

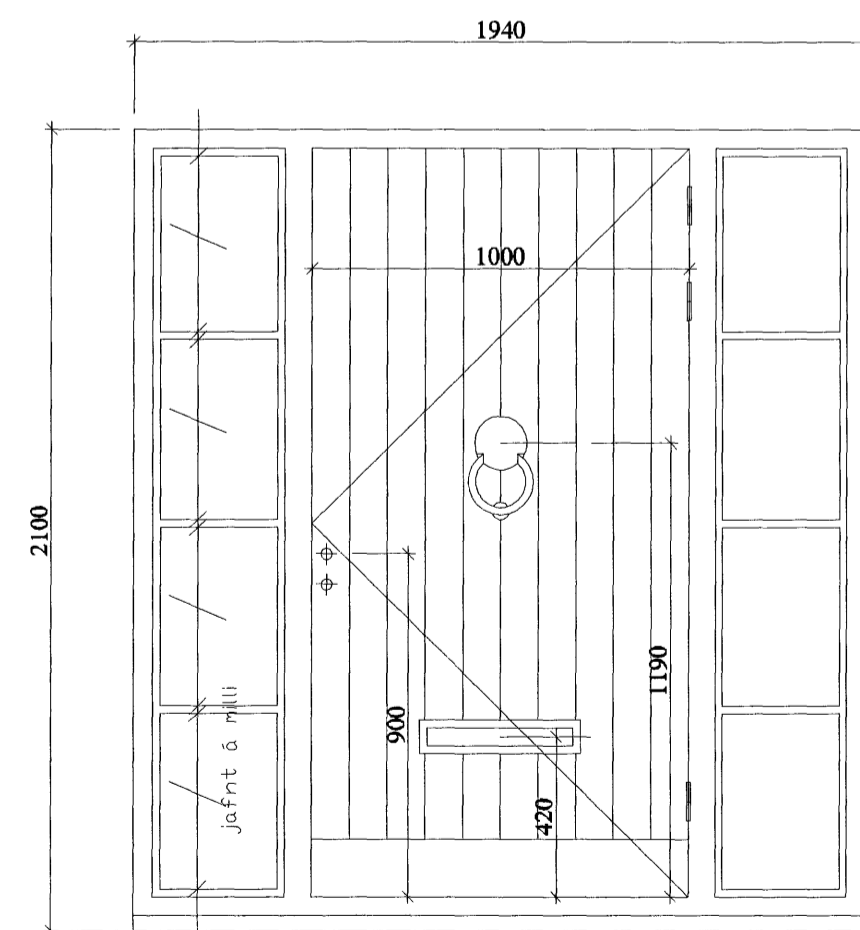

H7  
X1

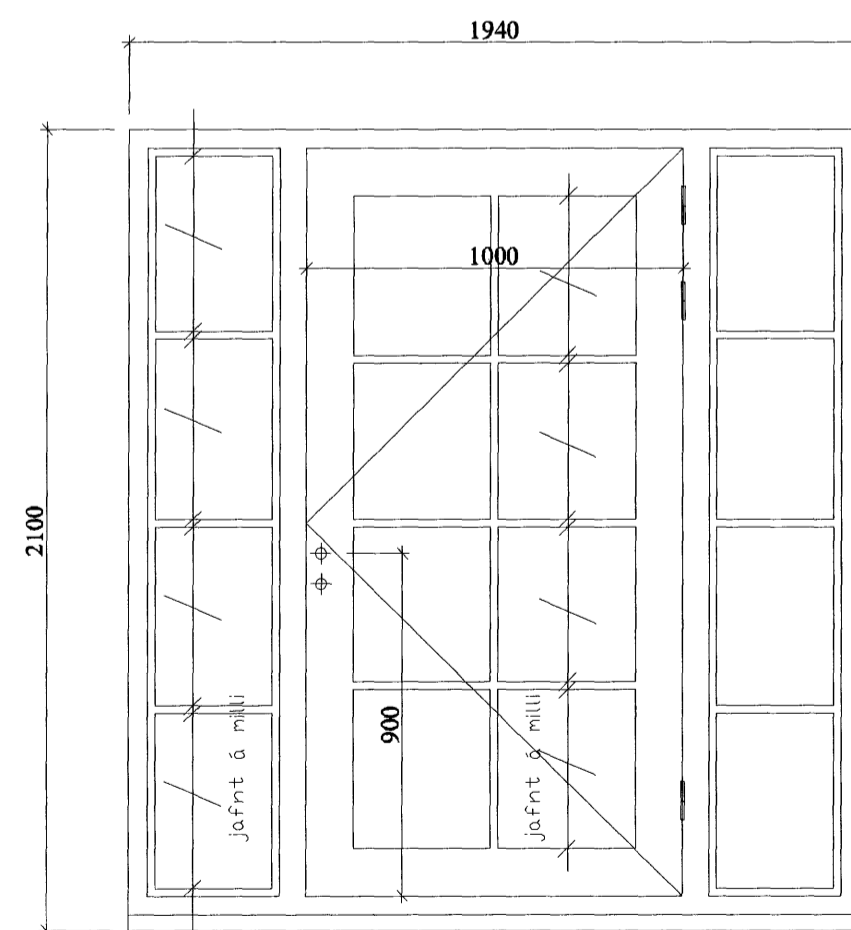

H13, H6  
X2

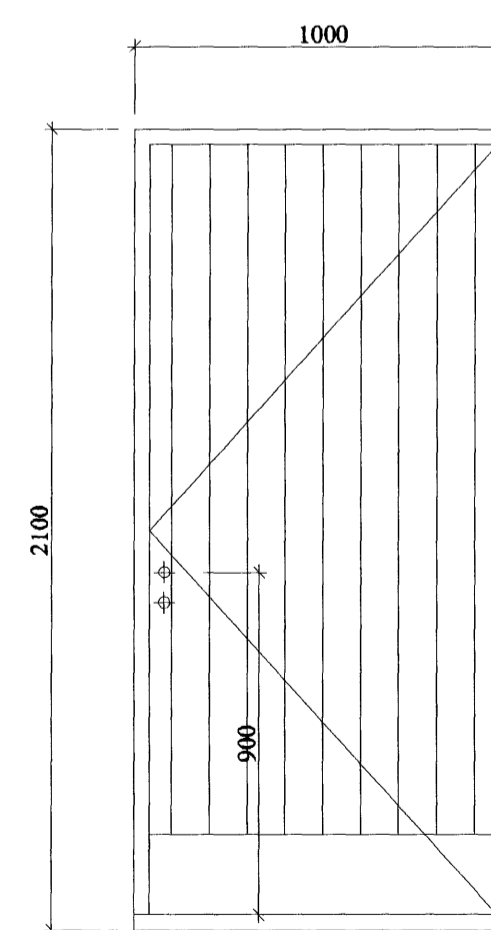

H2, H15  
X2

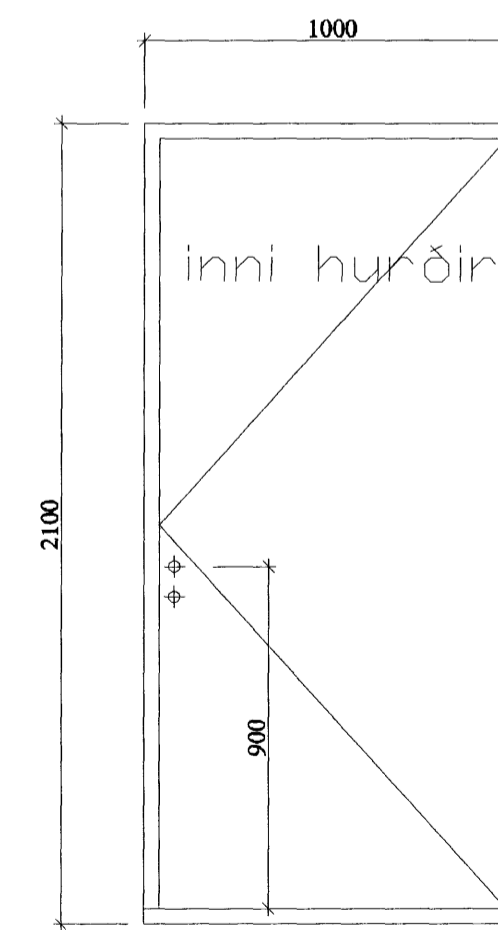

H4, H5, H8, H9, H10, H11, H12 og H14  
X8

Samþykkt þess  
13 JULI 2007

Byggingatulltrúinn í Hafnarfirði  
E.h. Sigurbjartur Halldórsson

○ sáeimur arkitektar hafnarfjörð

Yfirarið:  
Marteinn Huntingdon-Williams, RIBA; FAI  
Brattiholti 01-01 220 Hafnarfjörður  
kt: 130755-8019  
gsm: 869 7354  
© sáeimur arkitektar 2007

Drekavellir 43  
Hafnarfjörður

byggingaruppðrættir

Dags. 04.04.2007

Verknr. 157.0

Teiknr. 02-10

Efni. yfirlitsteining gluggar og hurðar

Mkv. 1:20