

20.36 120

Bending botnplötu # K12m120

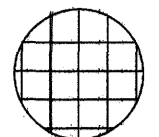

25030

20.36 120

Bending botnplötu # K12m120

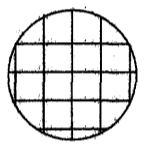

250 B 257

20.36 250

22.50 120

Bending botnplötu # K12m150

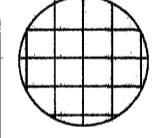

K:22.50

ATH. Nökvæm staðsetning á sprunguskilum sjá á teikningu arkitekta

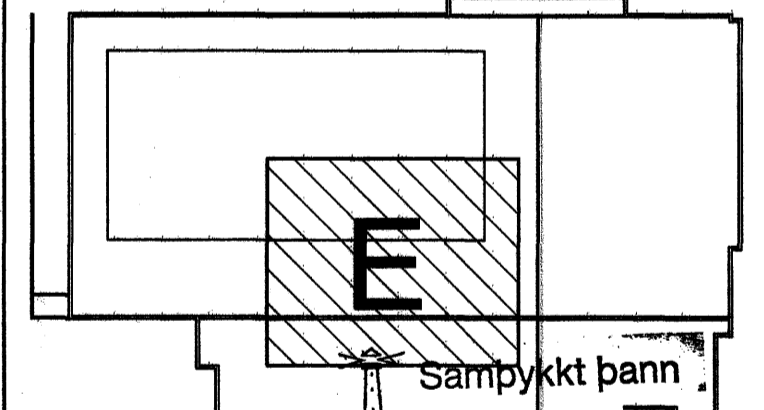

Samþykkt bann 24 JAN. 2008

Byggingulltrúinn í Hafnarfjarði F.h. Sigurbjartur Halldórsson

Skýringar sjá teikningu nr.300

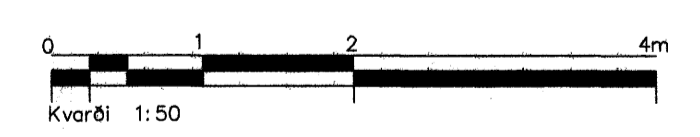

A	Sniðum brett við	SG	12.03.07
Ótg. Nr.	Breytingar	Höfundur	Daga

Verkefning

Ásvellir 2 – Sundmiðstöð Hafnarfjarðar

Strendingur ehf. Verkefniþjónusta
Fjarvegur 15-18 - 201 Hafnarfjarður
Sími 595 3444 Fax 595 3444

Burðarvirki- sökklar 1.h. og plata yfir kj. Grunnmynd – E

Daga nðv. 2006
Sökræmiþróun 191063-7599

Talman / Höfundur JW/SG

Malkvæði 1:50

Númer teikningar 214

Ölgufl. A

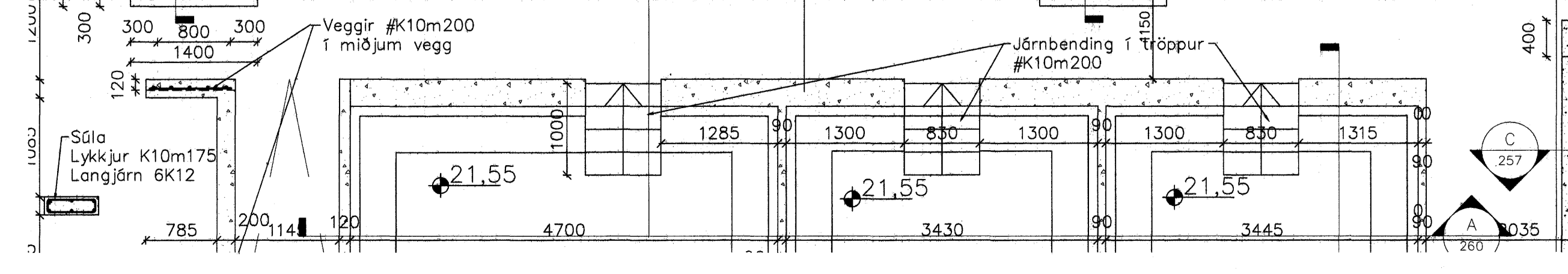
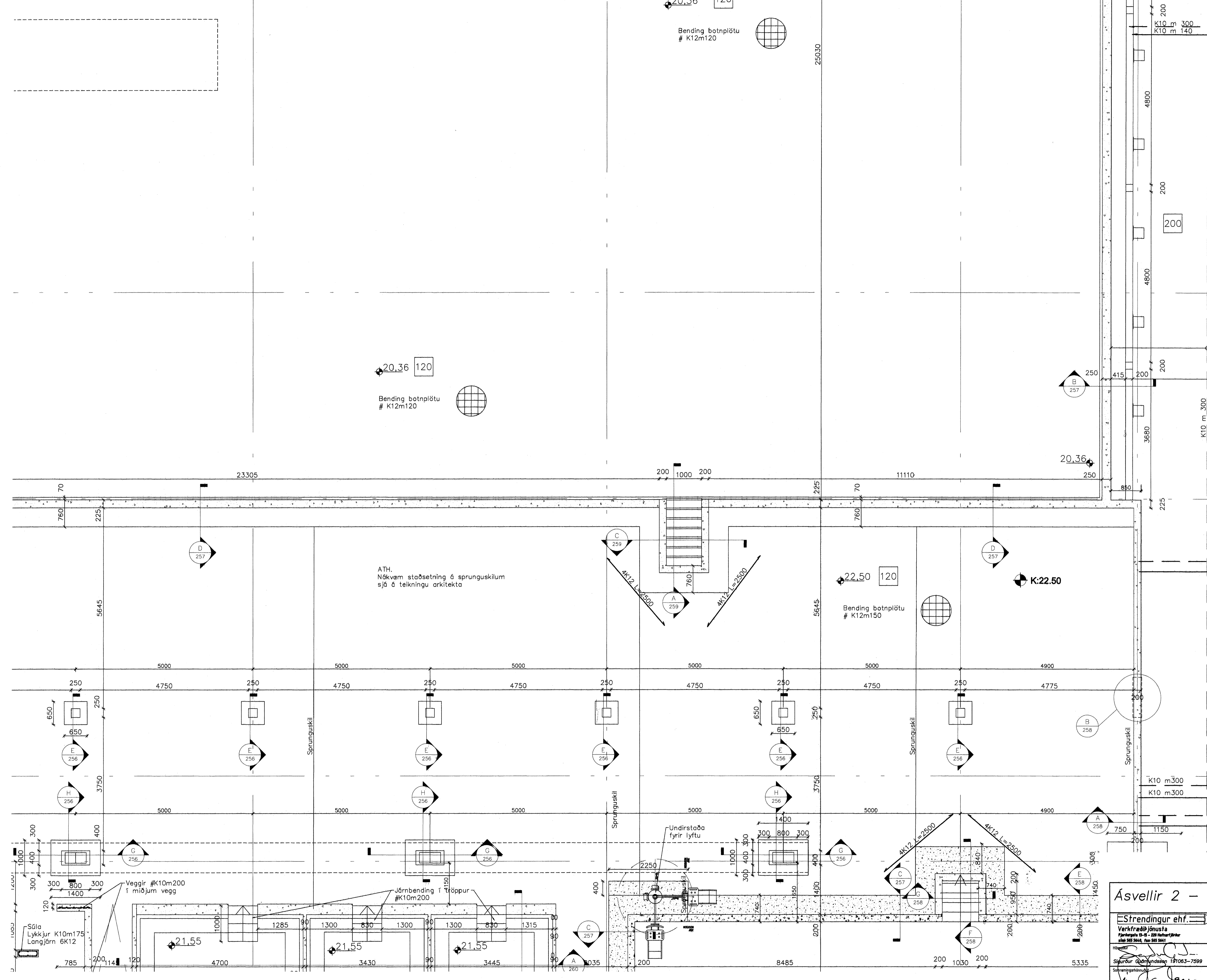

Sála Lykkjur K10m175 Langjárn 6K12

Veggir #K10m200 í miðjum vegg

Járnbinding í Tröppur #K10m200

Undirstaða fyrir lyftu

21.55

21.55

21.55

21.55

785

114

120

4700

1285

1300

830

1300

830

1315

90

3445

90

1035

200

8485

200

1030

200

5335