

AFSTÖÐUMYND, 1:500

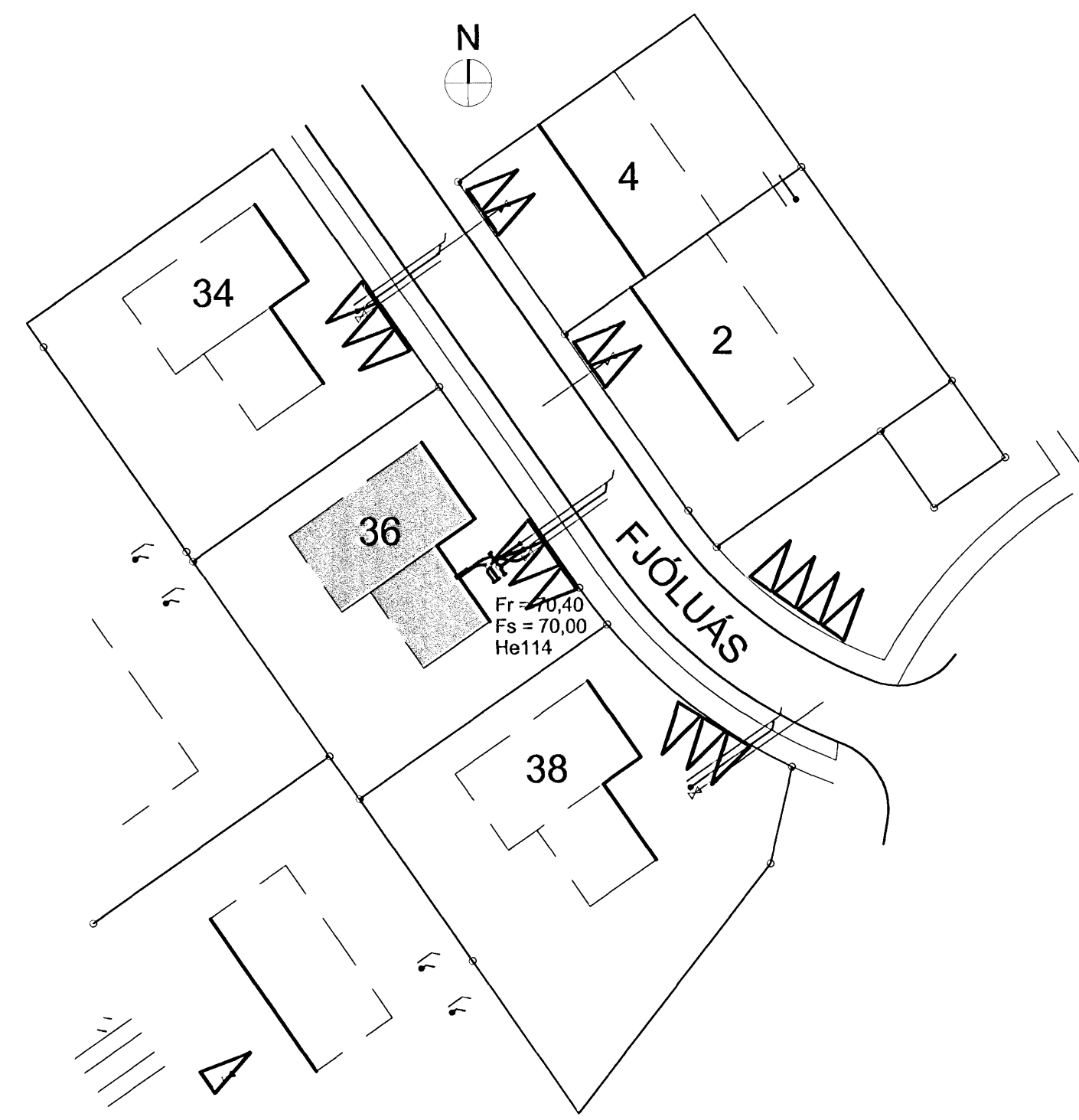

GRUNNMYND, 1:50

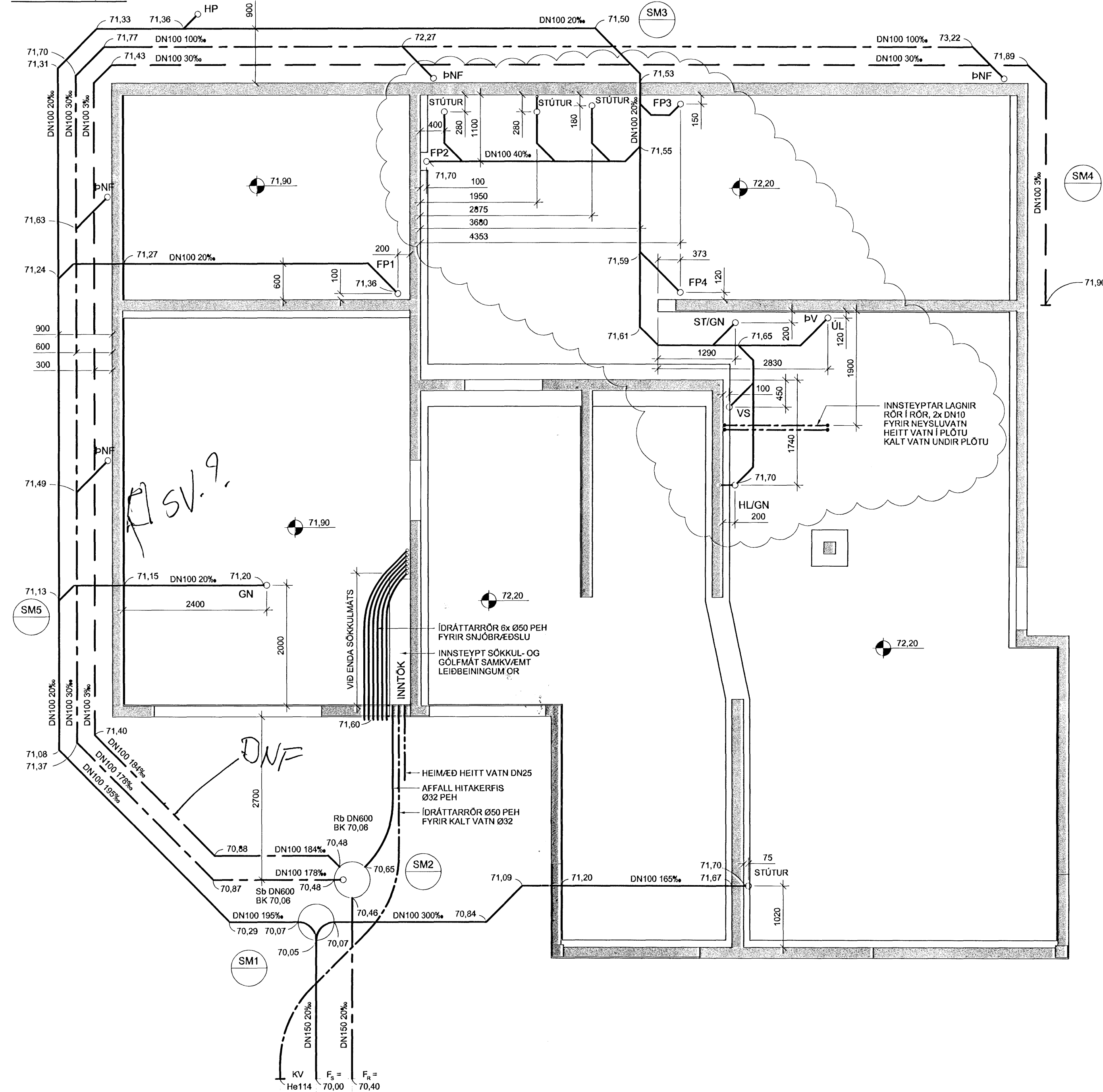

SM5 LÖGN UNDIR UNDIRSTÖÐU, 1:50
DÆMIGERT ÞVERSNIÐ

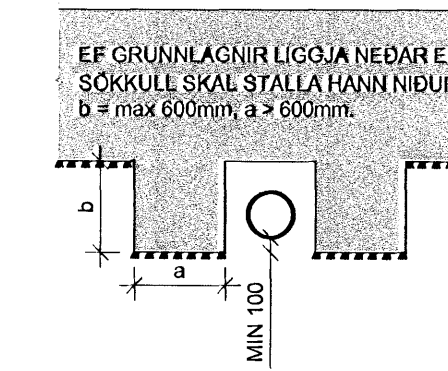

SM6 GÖT Í PLÖTU, 1:20

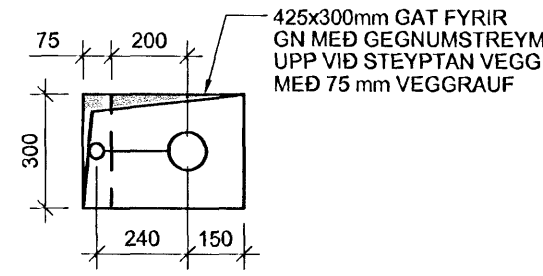
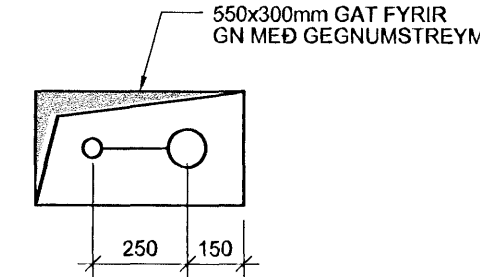
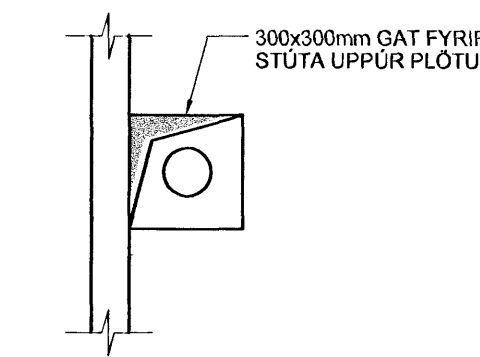

Samþykkt þann
23 OKT. 2007
Byggingulltrúinn í Hafnarfirði
F.h. Sigurbjartur Halldórsson

TILVÍSANIR:
ALMENNAR SKÝRINGAR SJÁ BL. NR. A-1
Ø = UTANMÁL PÍPU
DN = INNANMÁL PÍPU

SM1 DN600 SKÓLPBRUNNUR, 1:20
DÆMIGERT ÞVERSNIÐ

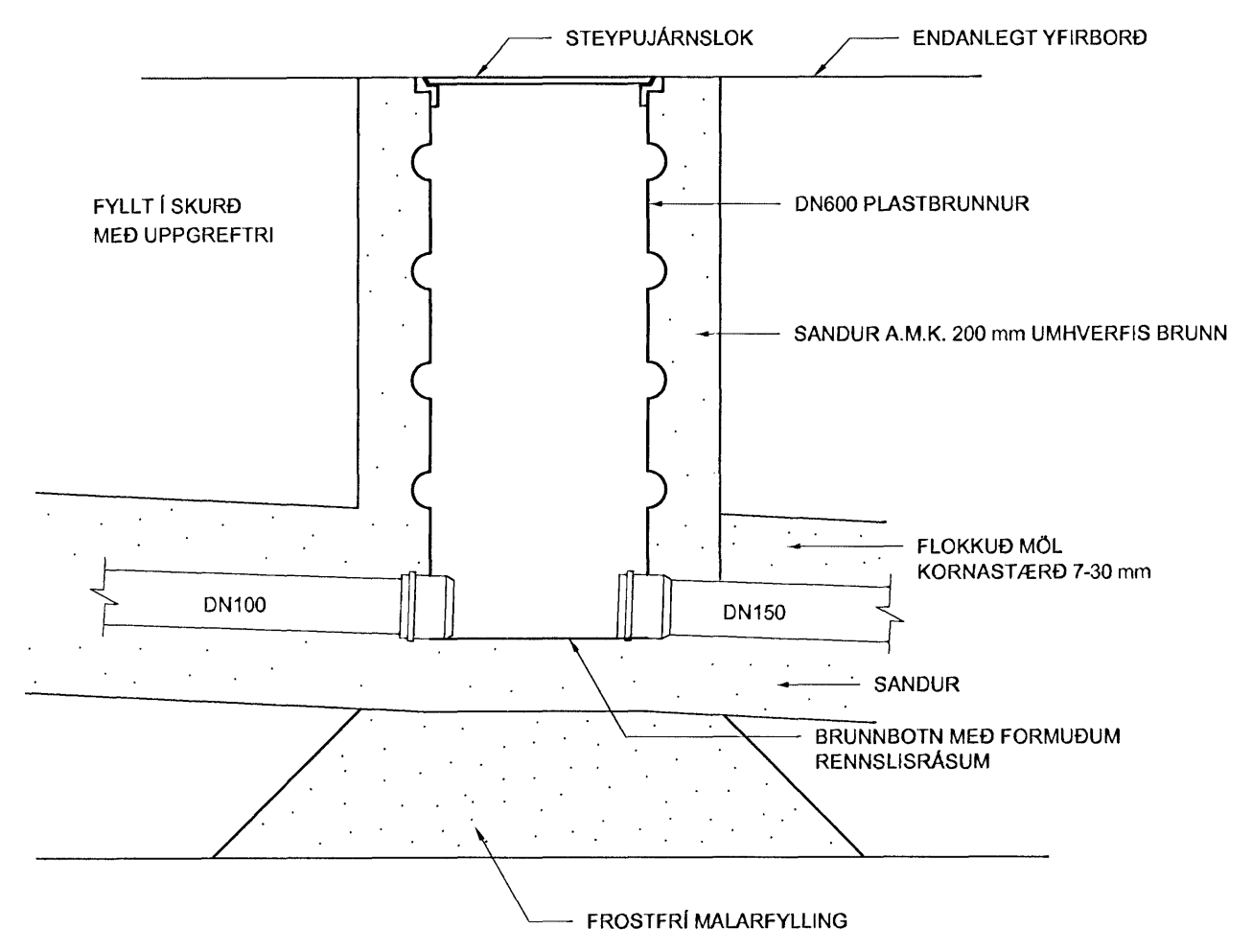

SM2 DN600 REGNVATNSBRUNNUR, 1:20
DÆMIGERT ÞVERSNIÐ

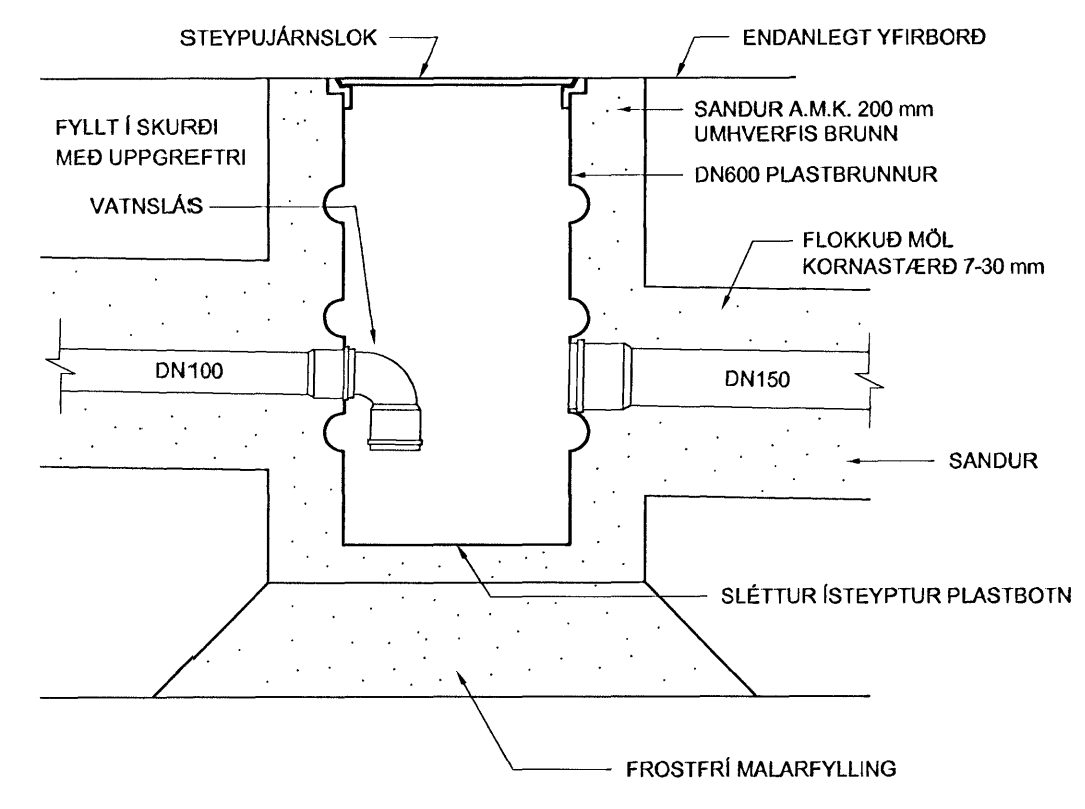

SM3 LÖGN GEGNUM UNDIRSTÖÐU, 1:20
DÆMIGERT ÞVERSNIÐ

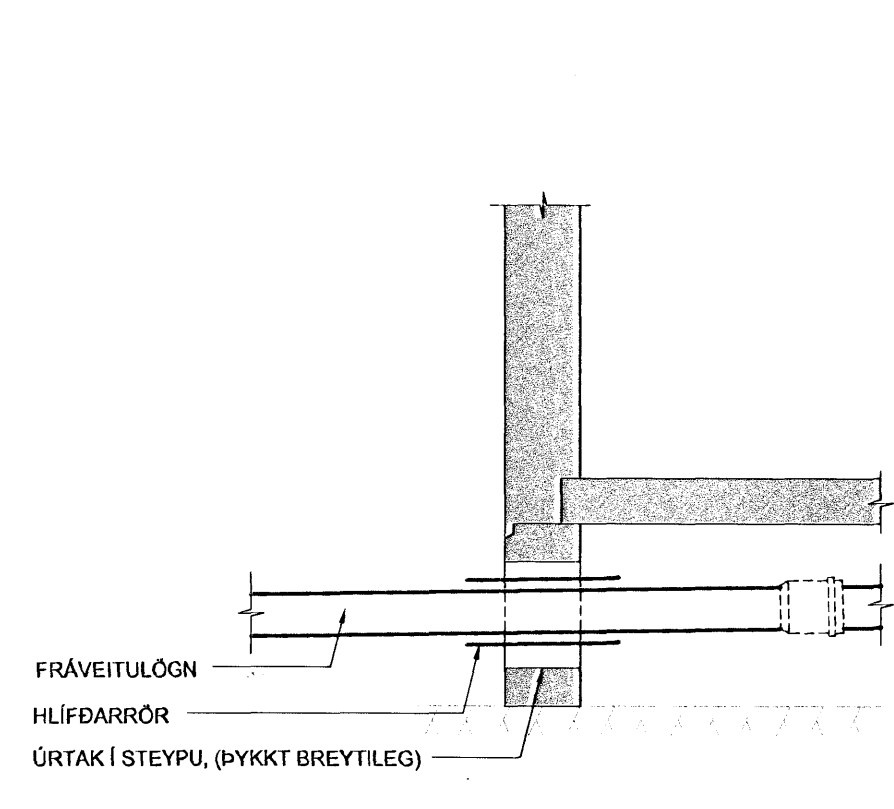

SM4 RÆSILÖGN, 1:20
DÆMIGERT ÞVERSNIÐ

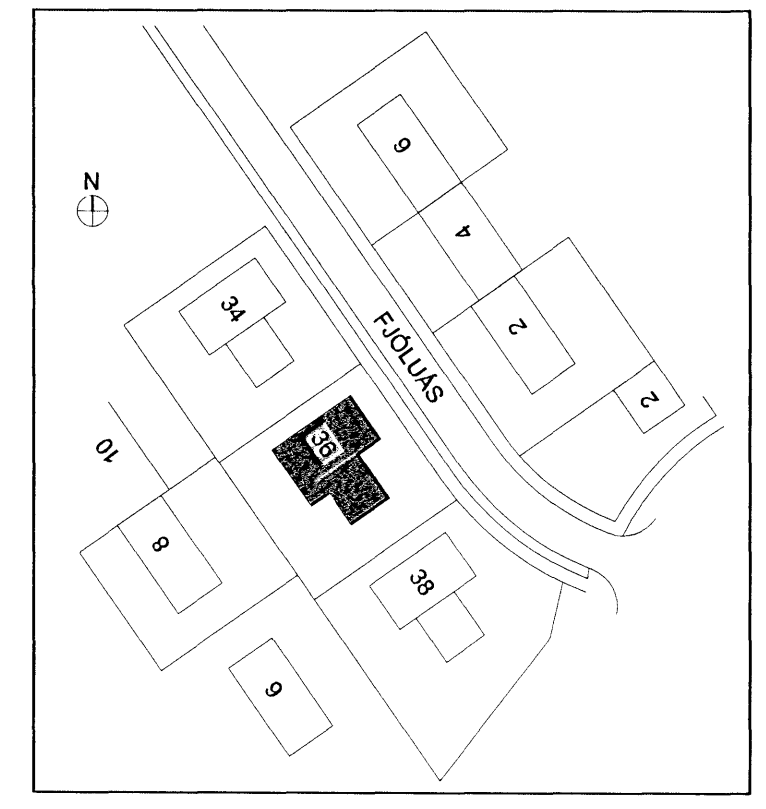
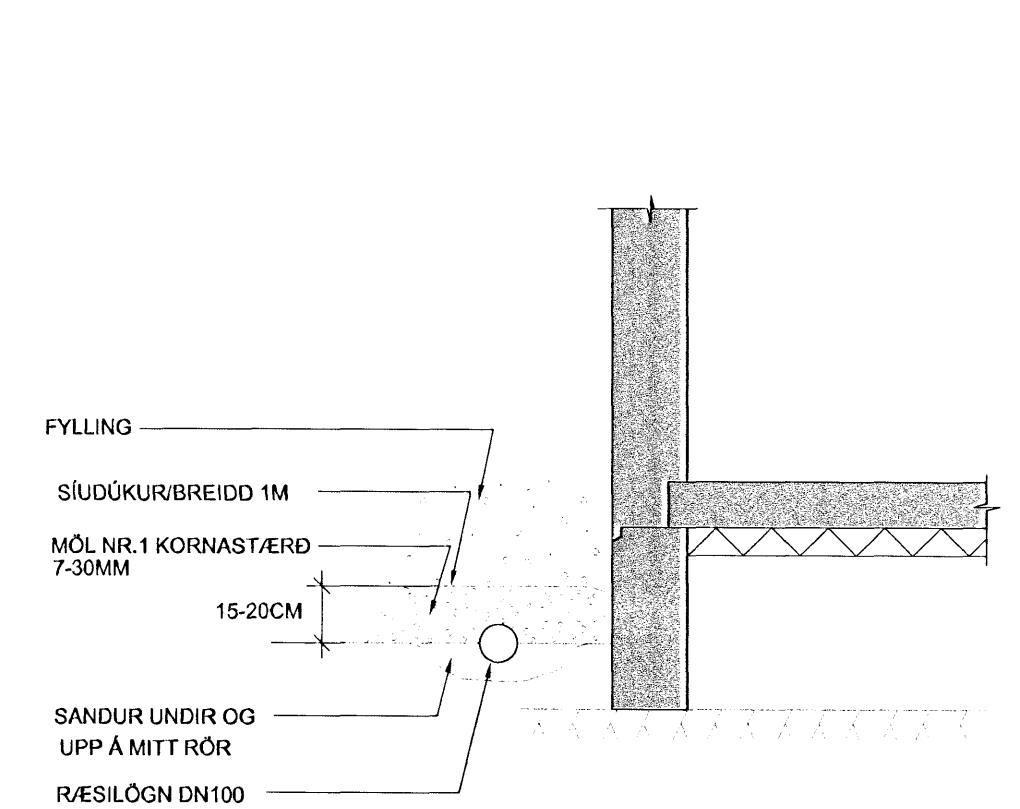

VSÓ RÁÐGJÖF
BORGARTÚN 20, 105 REYKJAVÍK, Sími 565-9000, Sími/Fax 565-9010, Netfang vs@vs.is

FJÓLUAS 36 - HAFNARFIRÐI

PRÍFAKERFI	HANNAÐIERN	Þ/Þ/Þ/Þ/Þ
LAGNIR Í GRUNNI	YFIRFARIR	Þ/Þ/Þ/Þ/Þ
GRUNNMYND, AFSTÖÐUMYND	SAMÞYKKT	Þ/Þ/Þ/Þ/Þ
SÉRMYNDIR OG SNID	KT.	300857-080
KVARDI A1/1:200, 50, 20	REYKJAVÍK	31.05.2007
VERNRN	TEKRN NR.	BR.

L1-GSUY-1

81200*0820081.agri/0nyggisbu08/Futla:arh:munuGkktar_tsk001B1L1A-1.dwg