

AFSTÖÐUMYND MKV. 2

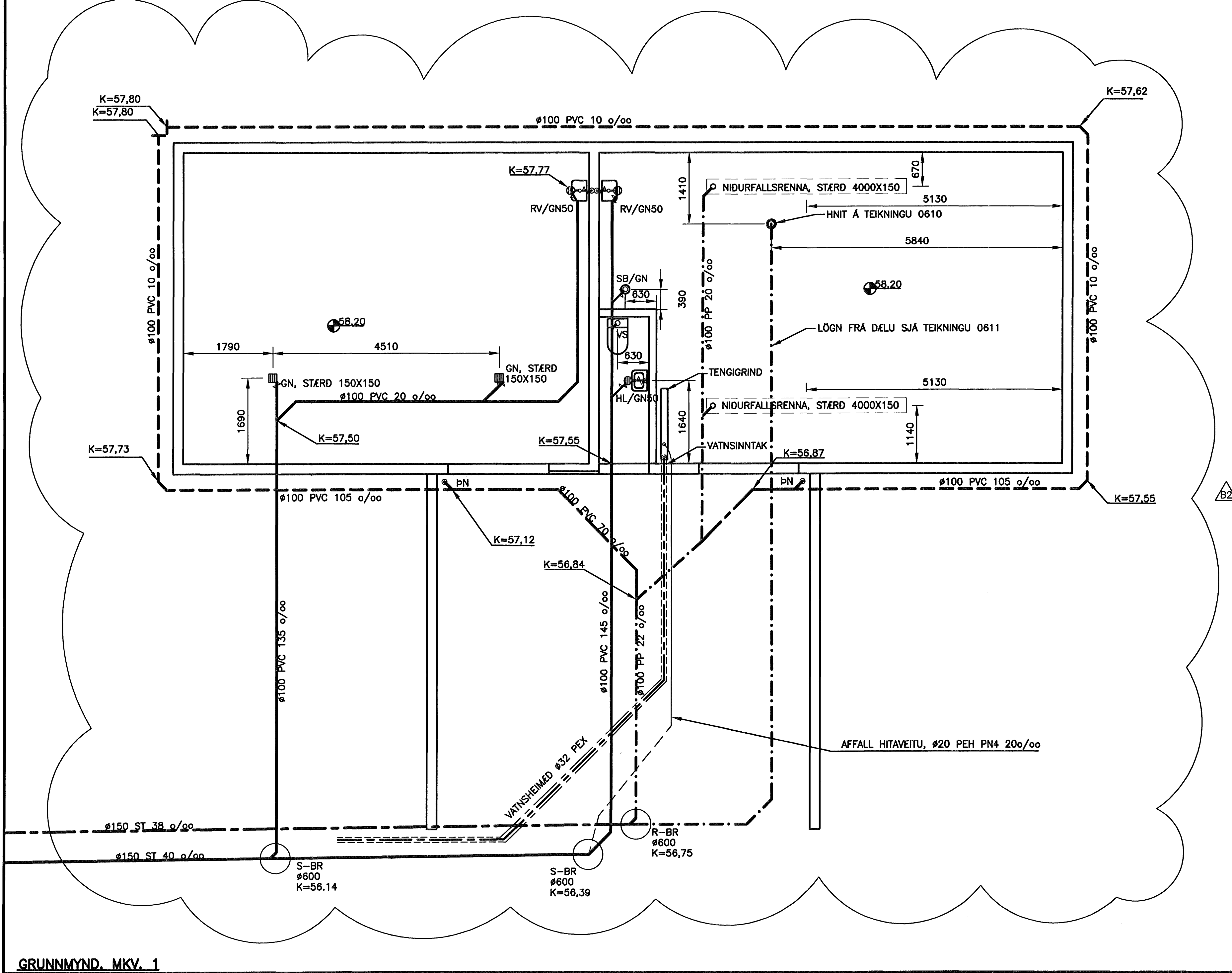

GRUNNMYND MKV. 1

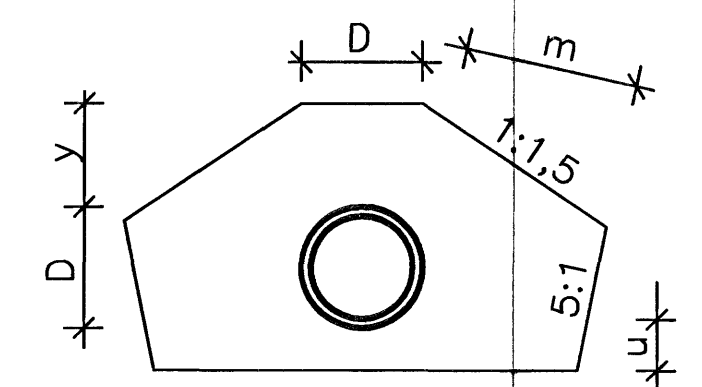
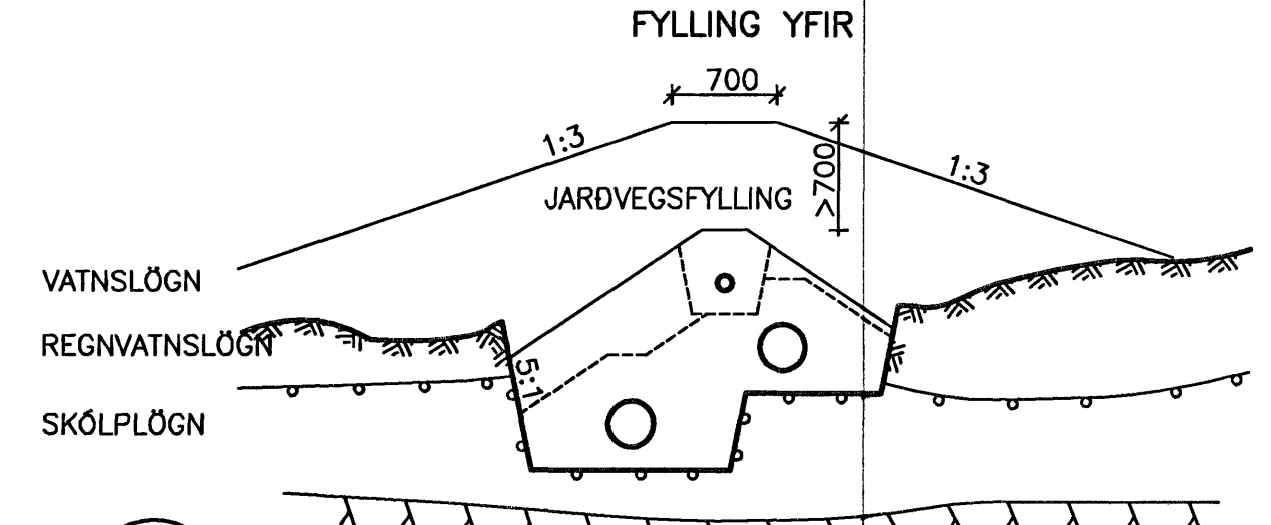
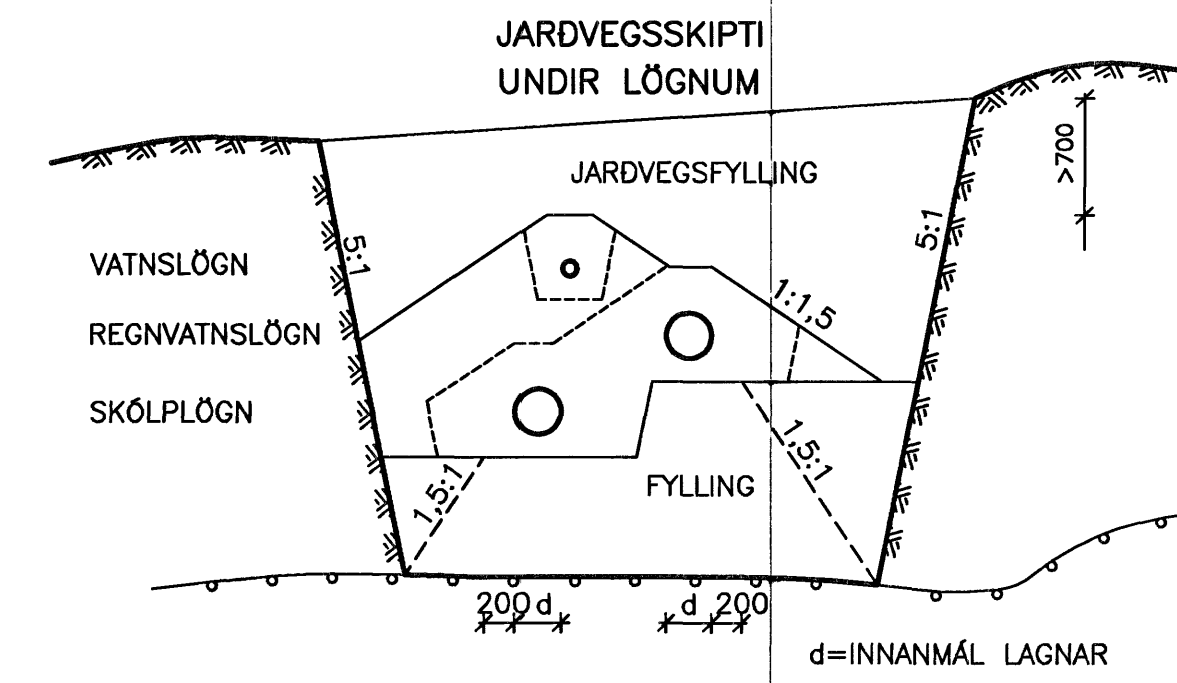
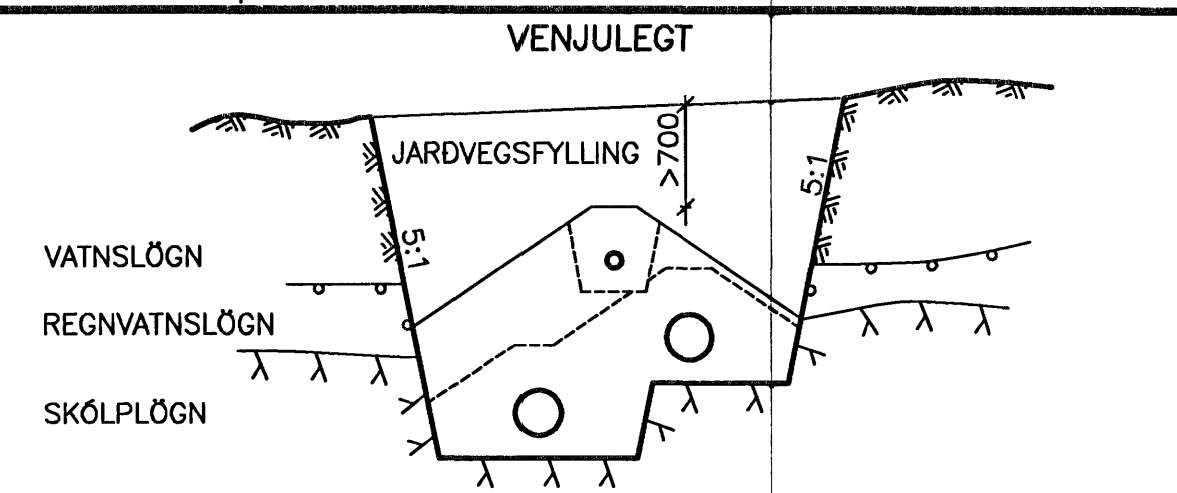

u MIDAST VÍÐ RENNSLISBOTN RÖRS.
m MIDAST VÍÐ YTRA BORD RÖRS.
y MIDAST VÍÐ YTRA BORD RÖRS.

STEYPT RÖR			SÖNDUN		
INNANMÁL d	VEGGÞYKKT t	UTANMÁL D	MEÐFRAM m	UNDIR u	YFIR y
100	24	148	200	150	300
150	33	216	200	150	300
200	37	274	200	150	300
250	42	334	500	150	300
300	54	408	500	150	300

VATNSLAGNIR			SÖNDUN		
INNANMÁL d	VEGGÞYKKT t	UTANMÁL D	MEÐFRAM m	UNDIR u	YFIR y
			200	150	300

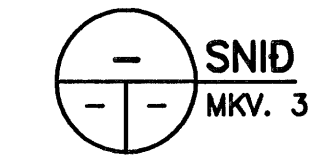
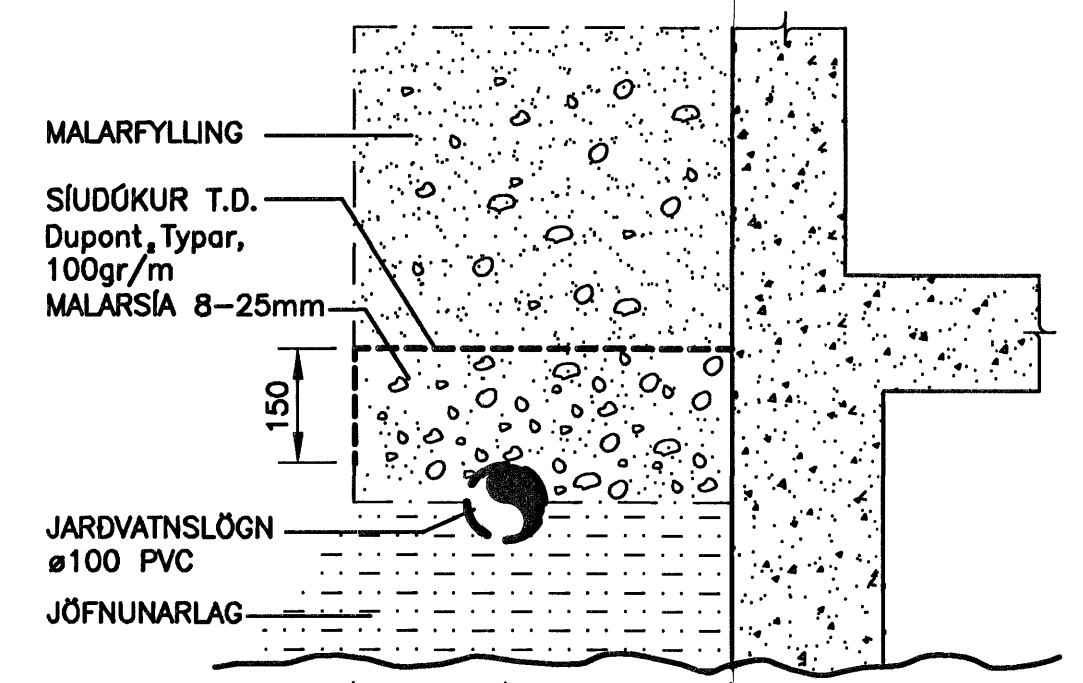

ÓTGÁFUERILL			
NÚMÉR:	DAGS:	SKÝRINGAR:	HANNAÐ:
B1	26.05.2007	BYGGINGARTEIKNING	KÁK
B2	28.08.2007	ALMENNAR BREYTINGAR Á LÖGNUM	JÞ-G

- SKÝRINGAR:**
- MERKINGAR:**
- SKÓPLÖGN
 - - - REGNVATNSLÖGN
 - - - JARDVATNSLÖGN
 - - - VATNSLÖGN
 - OG — VATNSLÁS
 - STÚTUR Í GÓLFI
 - FALLPIPA
 - LEIDSLA UPP
 - LEIDSLA NIÐUR
 - ST
 - PÍPUR ÚR STEINSTEYPU
 - PVC PÍPUR ÚR POLYVINYLKLÖRID
 - PP PÍPUR ÚR POLYPROPYLEN
 - PEH PÍPUR ÚR POLYETHYLEN
 - HL HANDLAUG
 - VS VATNSSALERNI
 - SB STEYPIBÁÐ
 - GN GÓLFNIÐURFALL
 - NF NIÐURFALL
 - ÞN ÞAKNIÐURFALL
 - SN SVALANIÐURFALL
 - VL VATNSLÁS
 - BR BRUNNUR
 - H HREINSISTÚTUR

Sampykkt þann 10 SEPT. 2007
Byggingulltrúinn í Hafnarfirði
F.Þ. Sigurbjartur Halldórsson

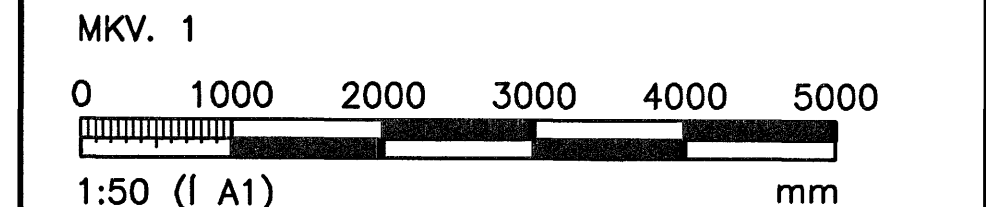
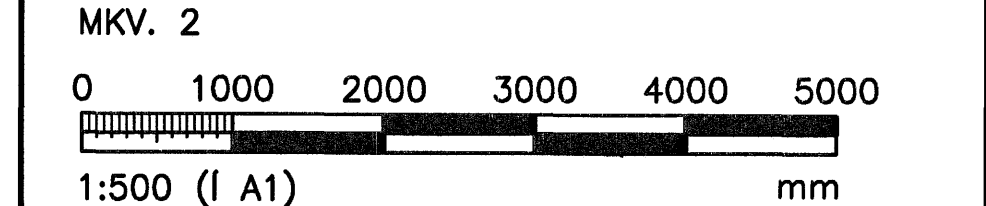
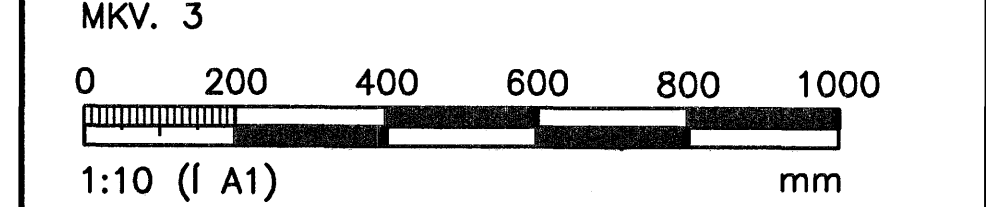

ÖLL AFNOT OG AFREITUN TEIKNINGAR, AD HILTA EDA HELD, ER HÁÐ SKRIFLEIÐU LEYFI HÖFUNGA.

VGK HÖNNUN
 GRÆNSÁVEGI 1 · 108 REYKJAVÍK · Sími: 422 3000 · Fax: 422 3001
 VEFANG: www.vgkhonnun.is · NETFANG: vgkhonnun@vgkhonnun.is

VEITUHÚS DALSAÐ 14a

FRÆVEITULÖGN: AFSTÖÐUMYND, GRUNNMYND OG SÉRMYNDIR

MELT:	TEIKNAR:	KÁK	GETMSLUNUMER:	YMR:	1.153.275
HANNAÐ:	YFIRFARID:	ÞB	MKV:	NR. TEIKNINGAR:	
DAGS. UNDRISKRIFAR:	NAFN OG KT. HÖNNUNAR:				
UNDRISKRIF HÖNNUNAR:	VGK-HÖNNUN hf	430572-0169			
		200862-5119	ÓTGÁFA:		B2