

G3,G4  
X2

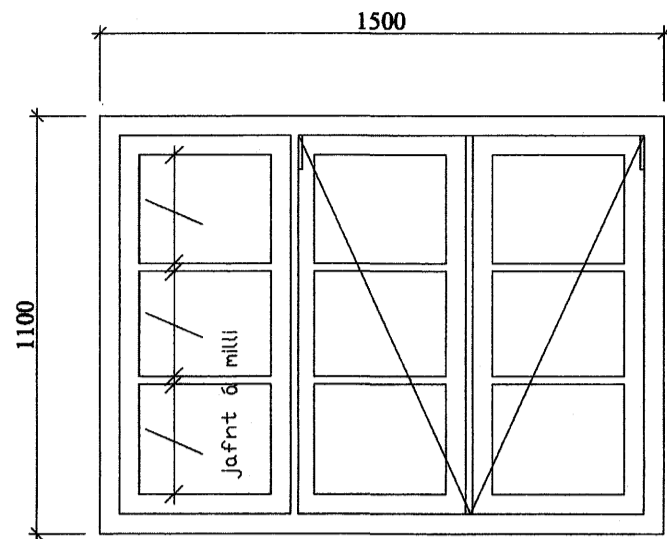

G5,G6  
X2

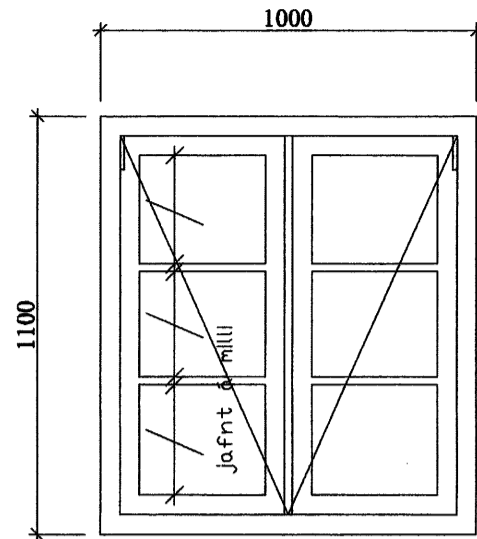

G1,G2,G7,G8,G9,G12,G13 og G14  
X8

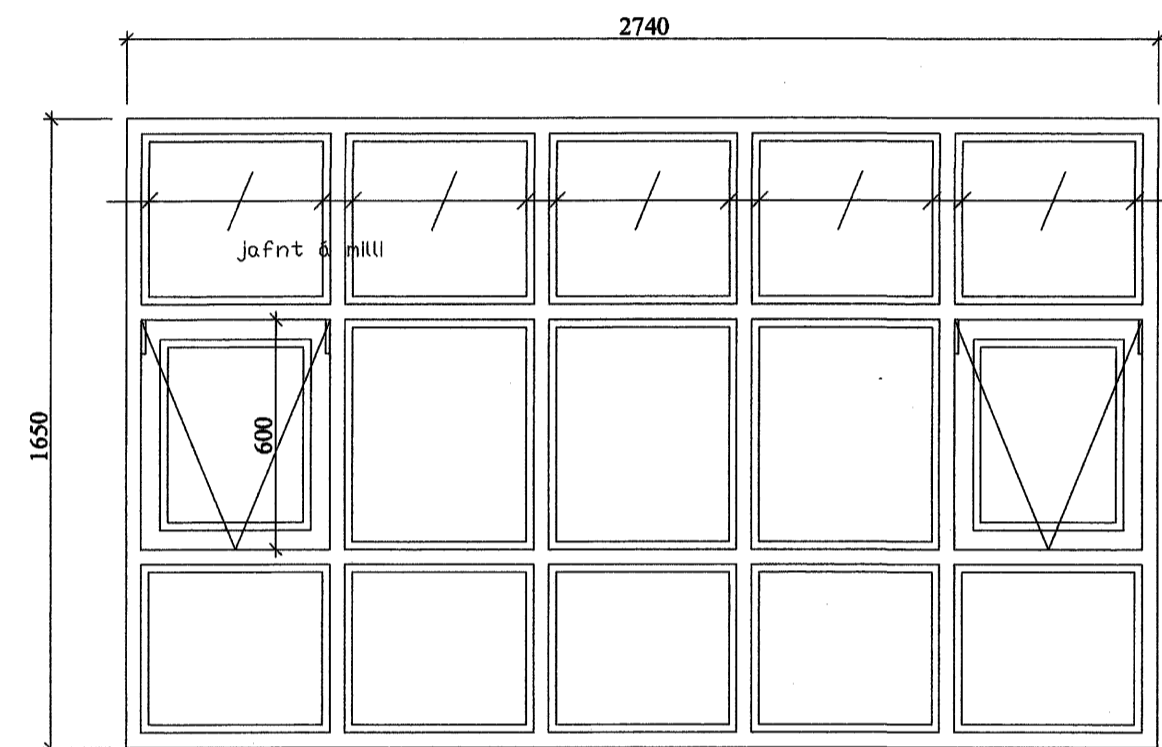

G12,G11  
X2

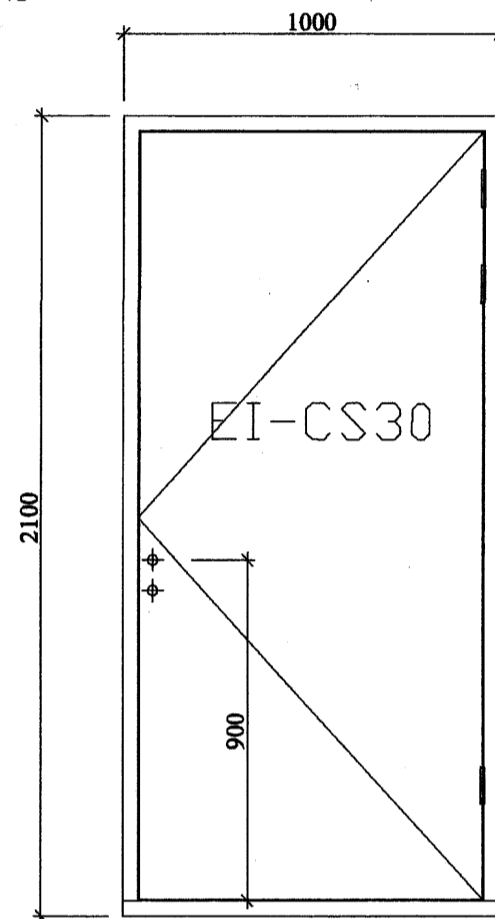

H3 og H16  
X2

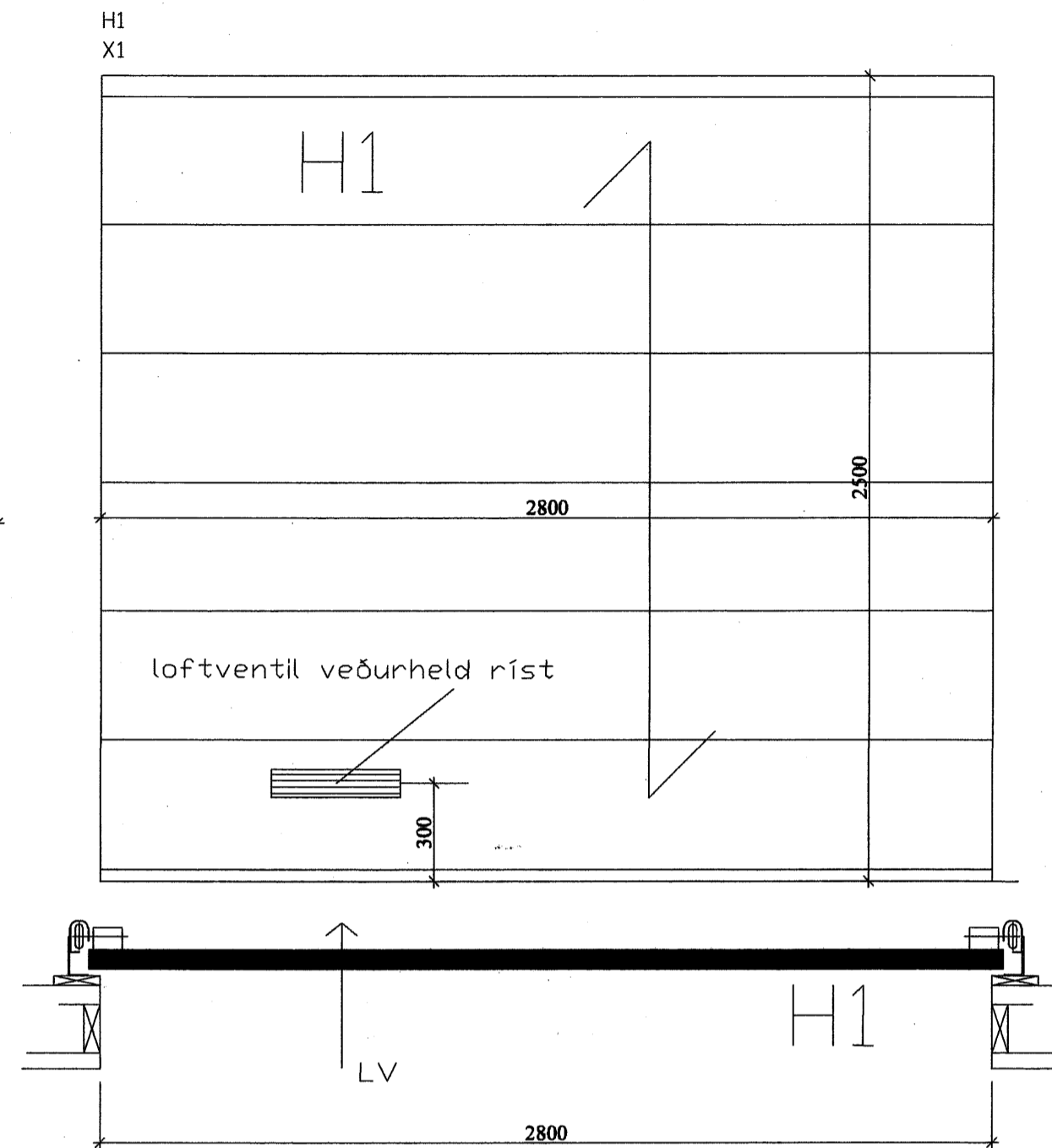

H1  
X1

Mæla skal upp á staðnum áður en sm  
ATH: Öll mál er op-mál ekki smíða-mál

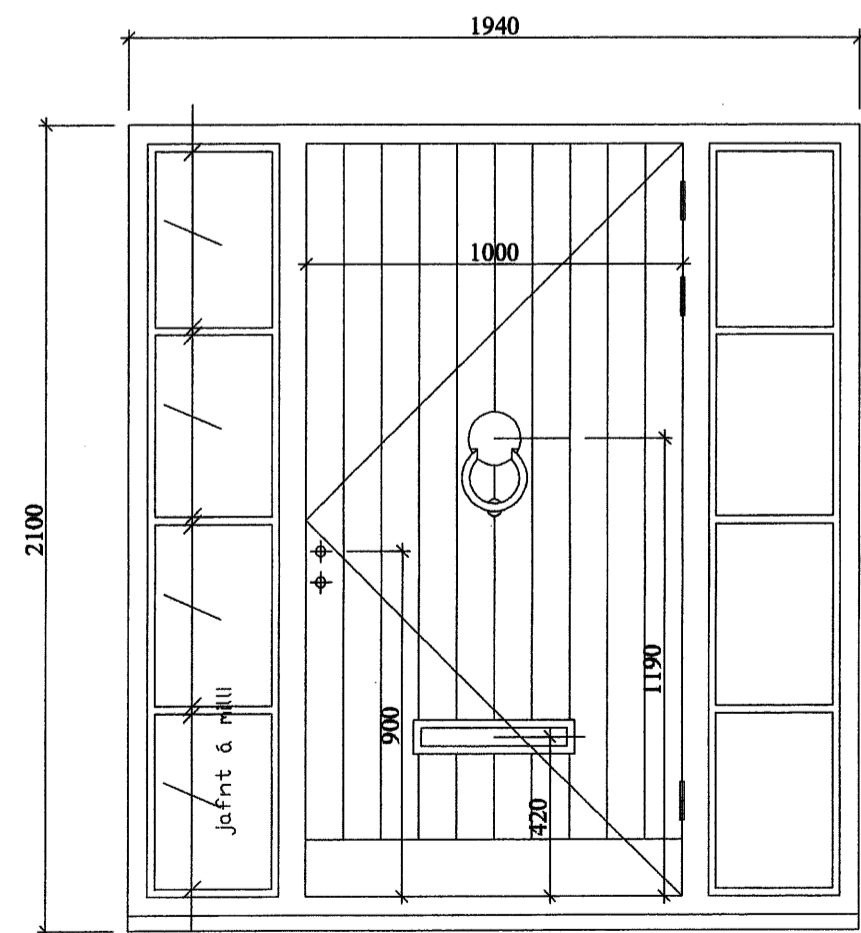

H7  
X1

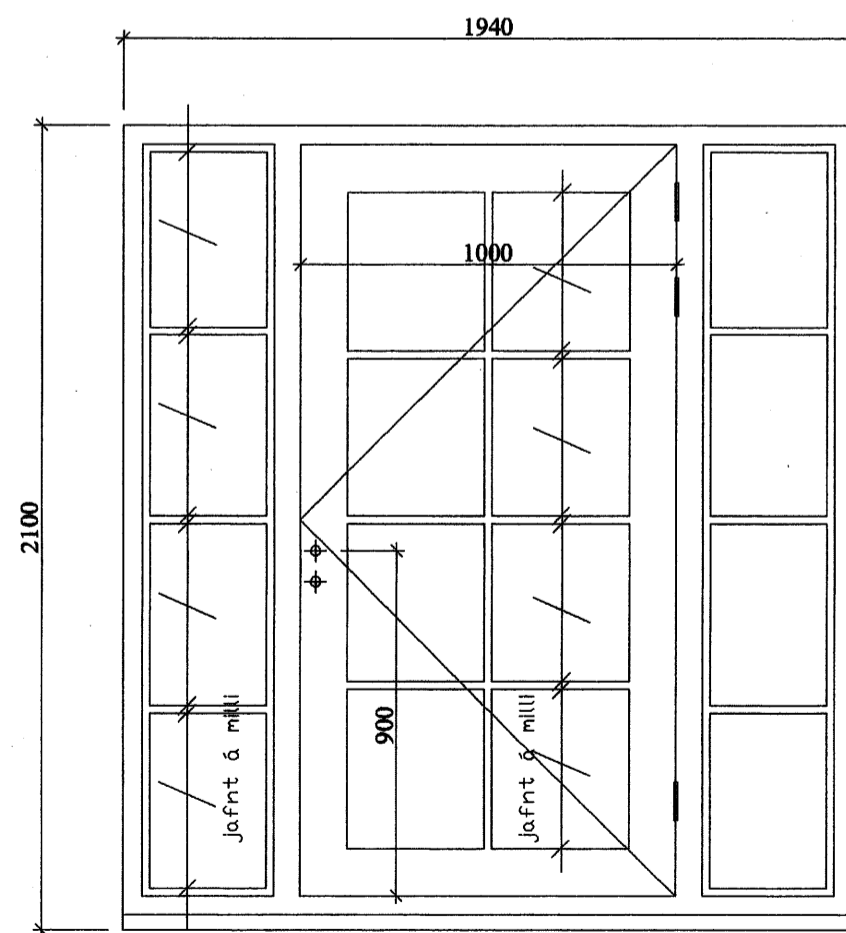

H13,H6  
X2

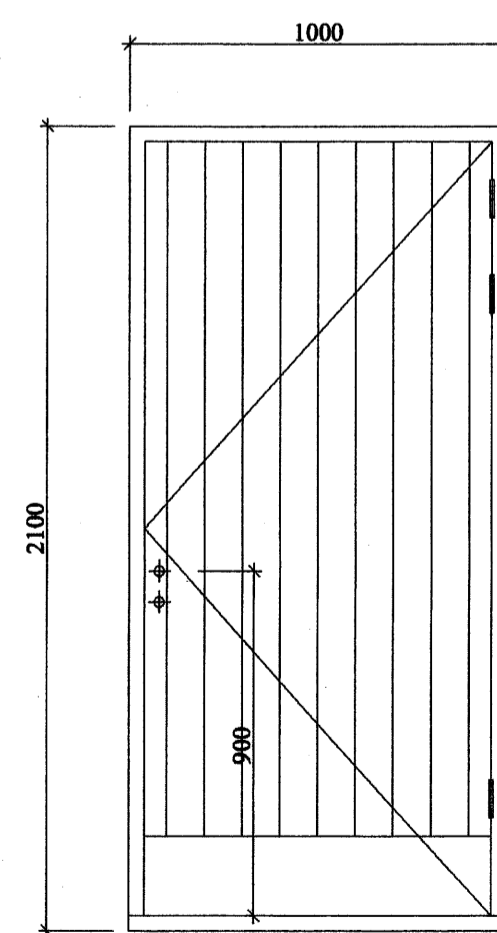

H2,H15  
X2

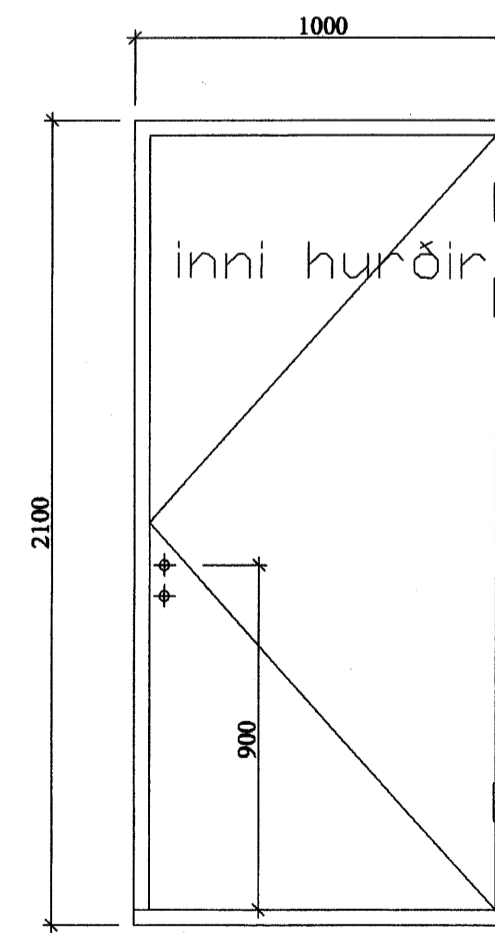

H4,H5,H8,H9,H10,H11,H12 og H14  
X8

○ sægeimur arkitektur hafnarfjörður

Yfirarið:  
Marteinn Huntingdon-Williams, RIBA; FAI  
Brattholti 01-01 220 Hafnarfjörður  
kt: 130755-8019  
gsm: 869 7354  
©sægeimur arkitektur 2007

Drekavellir 43  
Hafnarfjörður  Samþykkt þann  
28 MARS 2007

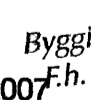
byggingaruppdrættir  Byggingafulltrúinn í Hafnarfirði  
Dags. 23.02.2007 F.h. Sigurbjartur Halldórsson

Verknr. 157.0  
Teiknnr. 02-10

Efni. yfirlitsteining gluggar og hurðar

Mkv. 1:20