

NR VEGGS	IV-101
FLATARMÁL (m ²)	8.2
RÖMMÁL (m ²)	1.6
ÞYNGD (T)	4.1
FRAGANGUR	Slettmúrað

IV-101

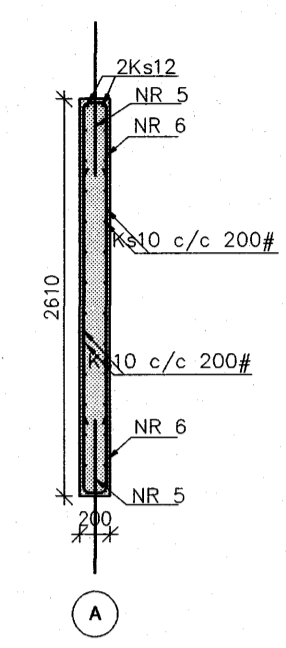
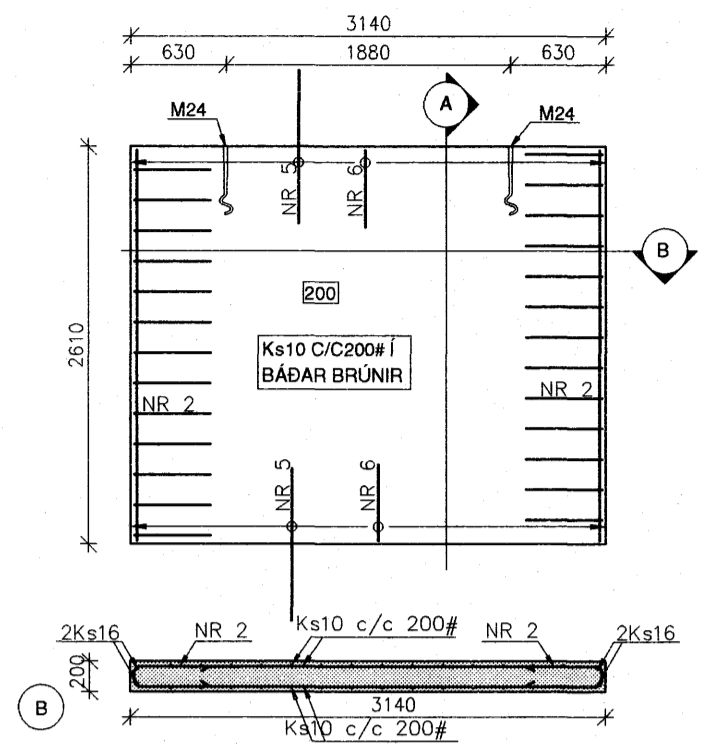

NR 6	Ks10 C/C 200	L=1150
NR 2	Ks10 C/C 200	L=1130
NR 5	Ks12 C/C 140	L=1000

NR VEGGS	IV-102
FLATARMÁL (m ²)	13.9
RÖMMÁL (m ²)	2.8
ÞYNGD (T)	7.0
FRAGANGUR	Slettmúrað

IV-102

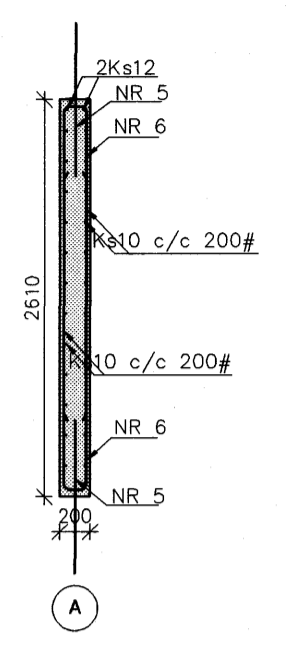
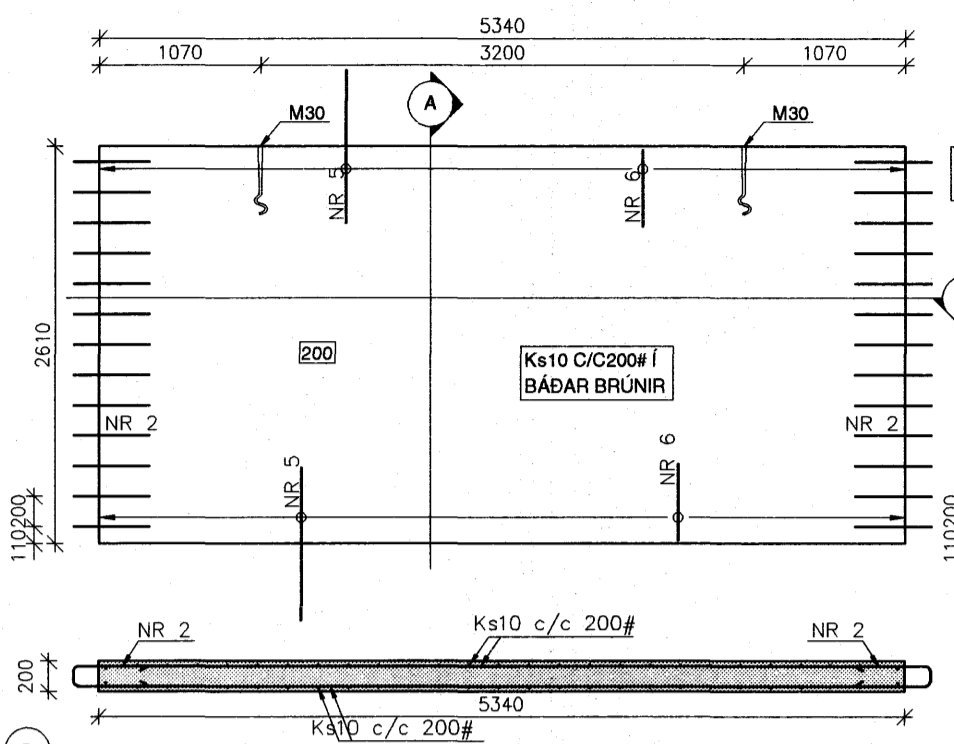

NR 6	Ks10 C/C 200	L=1150
NR 2	Ks10 C/C 200	L=1130
NR 5	Ks12 C/C 140	L=1000

NR VEGGS	IV-103
FLATARMÁL (m ²)	11.3
RÖMMÁL (m ²)	1.7
ÞYNGD (T)	4.2
FRAGANGUR	Slettmúrað

IV-103

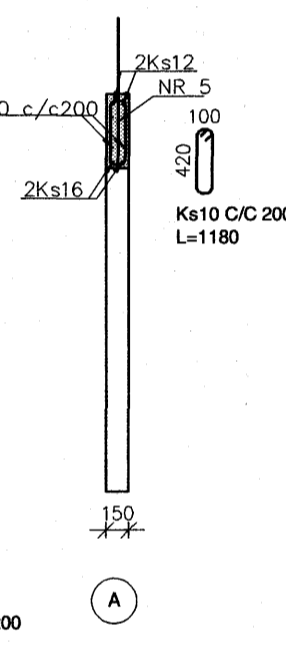
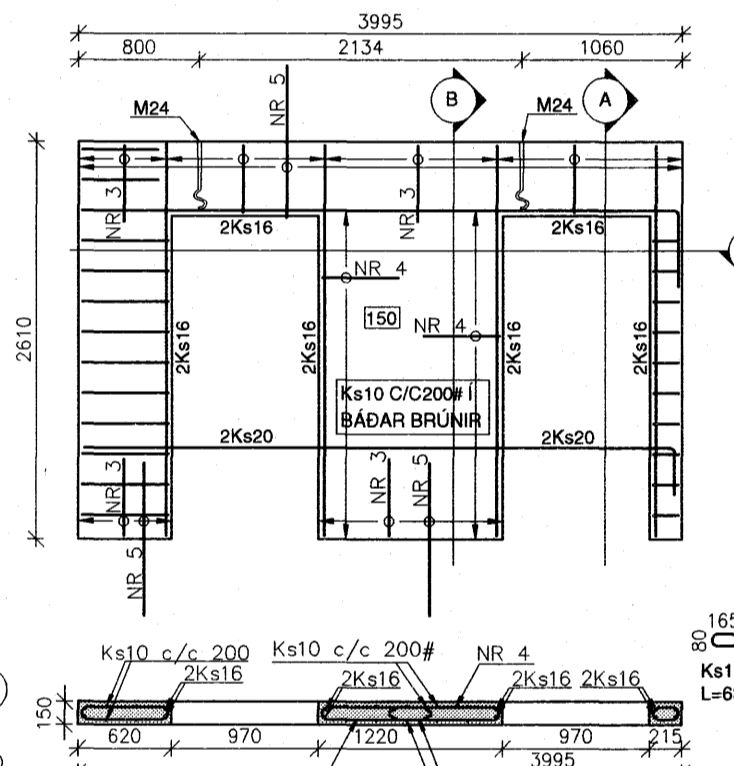

NR 3	Ks10 C/C 200	L=1100
NR 4	Ks10 C/C 200	L=1080
NR 5	Ks12 C/C 140	L=1000

NR VEGGS	IV-104
FLATARMÁL (m ²)	7.6
RÖMMÁL (m ²)	1.5
ÞYNGD (T)	3.8
FRAGANGUR	Slettmúrað

IV-104

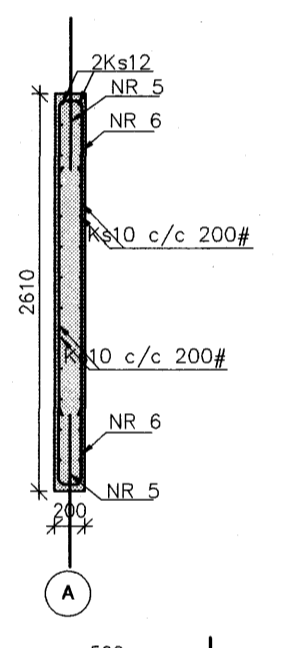
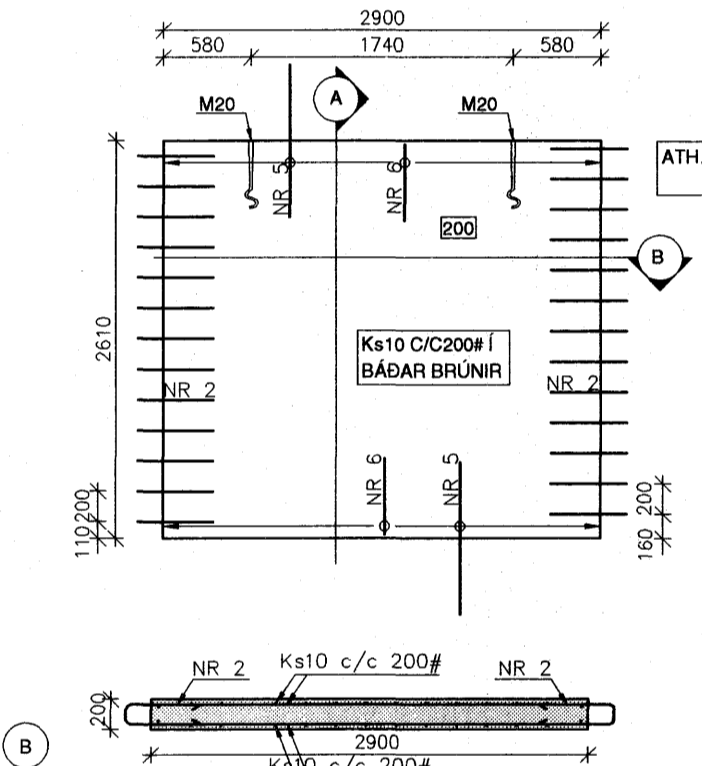

NR 6	Ks10 C/C 200	L=1150
NR 2	Ks10 C/C 200	L=1130
NR 5	Ks12 C/C 140	L=1000

NR VEGGS	IV-105
FLATARMÁL (m ²)	8.0
RÖMMÁL (m ²)	1.2
ÞYNGD (T)	3.0
FRAGANGUR	Slettmúrað

IV-105

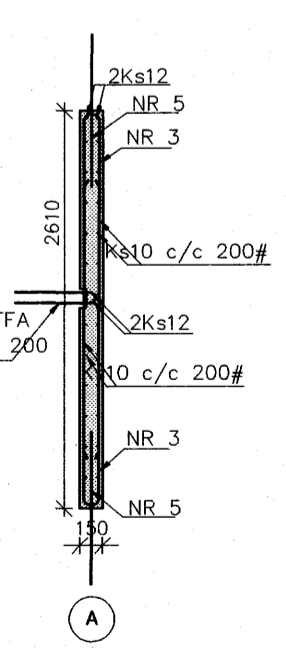
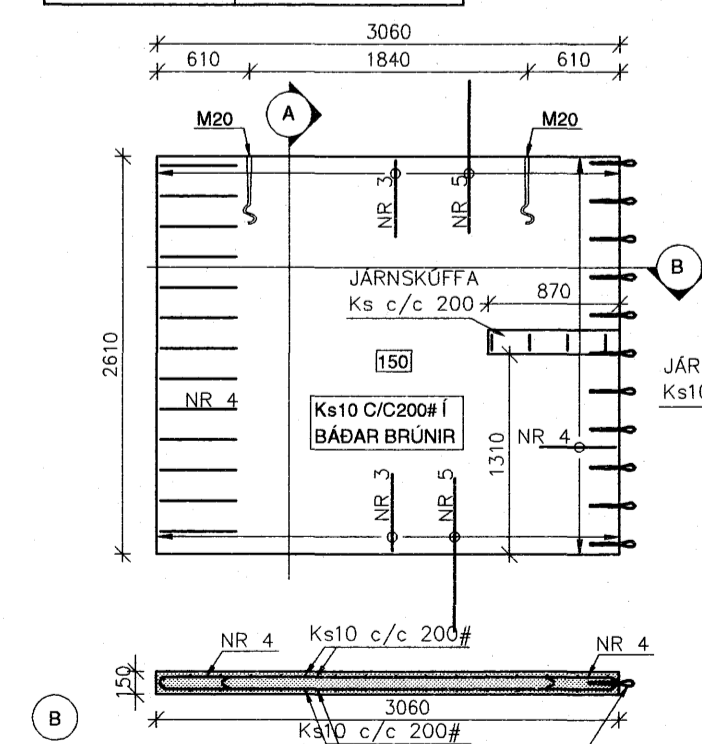

NR 3	Ks10 C/C 200	L=1100
NR 4	Ks10 C/C 200	L=1080
NR 5	Ks12 C/C 140	L=1000

NR VEGGS	IV-106
FLATARMÁL (m ²)	7.6
RÖMMÁL (m ²)	1.5
ÞYNGD (T)	3.8
FRAGANGUR	Slettmúrað

IV-106

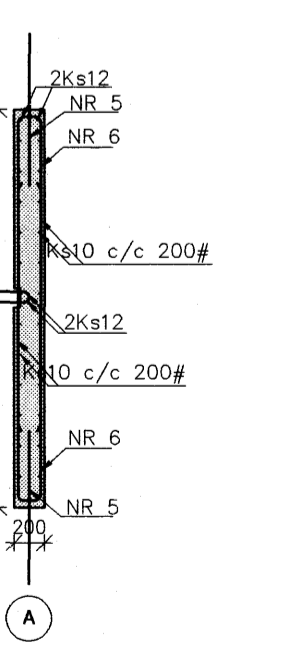
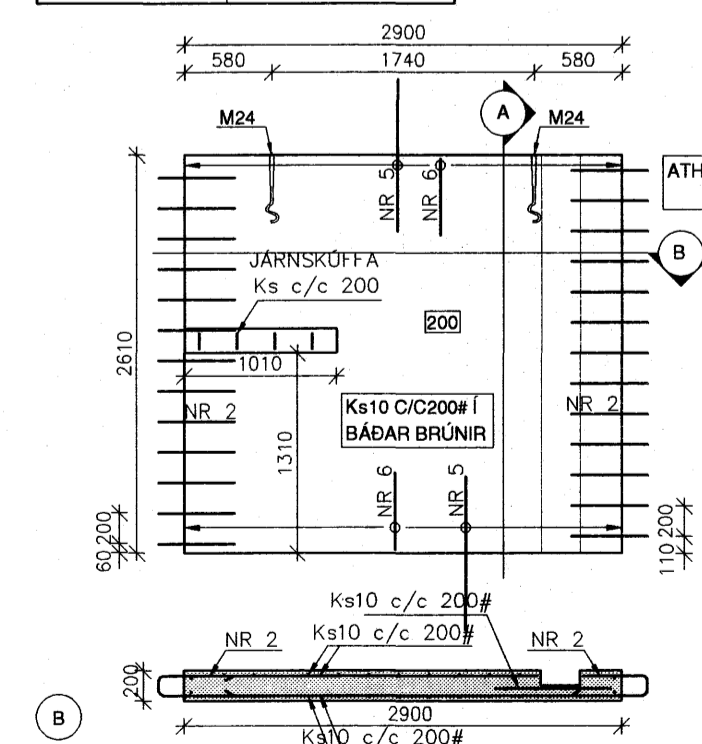

NR 6	Ks10 C/C 200	L=1150
NR 2	Ks10 C/C 200	L=1130
NR 5	Ks12 C/C 140	L=1000

SKÝRINGAR

Kótar eru í m.y.s
Málsetningar eru í mm

- Merkir hæðarkóti í sniði
 - Merkir hæðarkóti í plani
 - 150 Merkir þykkt plötu
- Sjá einnig skýringarblað

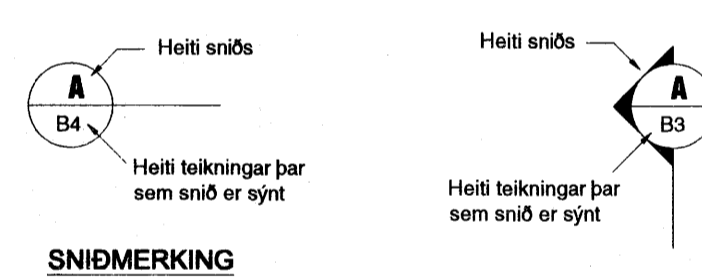
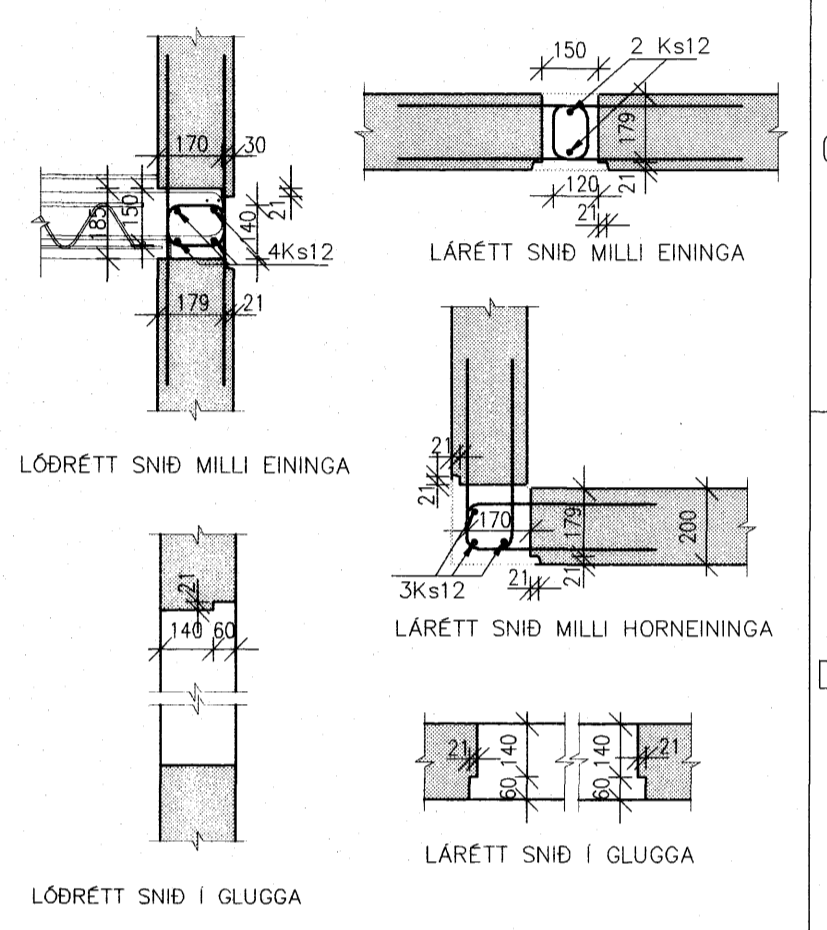

SNIÐMERKING

Samþykkt þann 16 FEB. 2007

Byggingafrúnnir í Hafnarfirði
F.h. Sigurbjartur Halldórsson

BREYTINGAR

Samþykkt Samþykki aðalhönnuðar *Þráng*

VEB Verkfæðistofa Erlends Birgissonar
Bajarind 4 201 Kópavogi
Sími 564 3322 Fax 564 3324
Netfang veb@veb.is, GSM 898 1198
Ráðgefandi verkfræðijónusta

VERKHEITI
SKIPALÓN 21
220 HAFNARFJÖRDUR

Teikning nr
B14

HEITI TEIKNINGAR
INNVEGGJAEININGAR
101-106

Dagsetning	Teiknað	Hannað	Kvarði	Töluheiti
JAN 2007	ARG	ESB	1:50/20	
		261156-2539		