

VEGGIR Í LÍNU J OG K 1:50

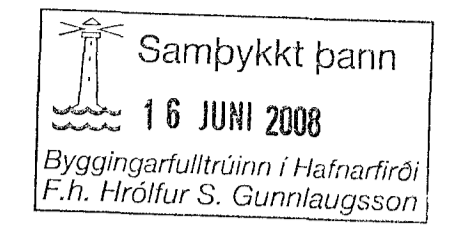
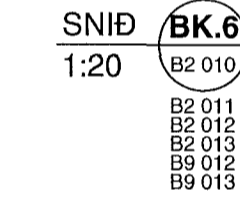
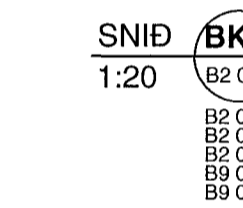
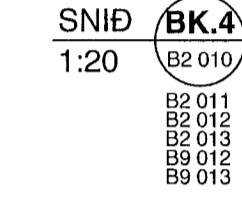
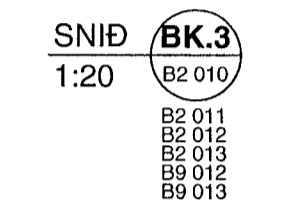
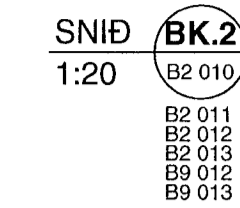
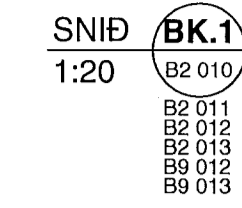
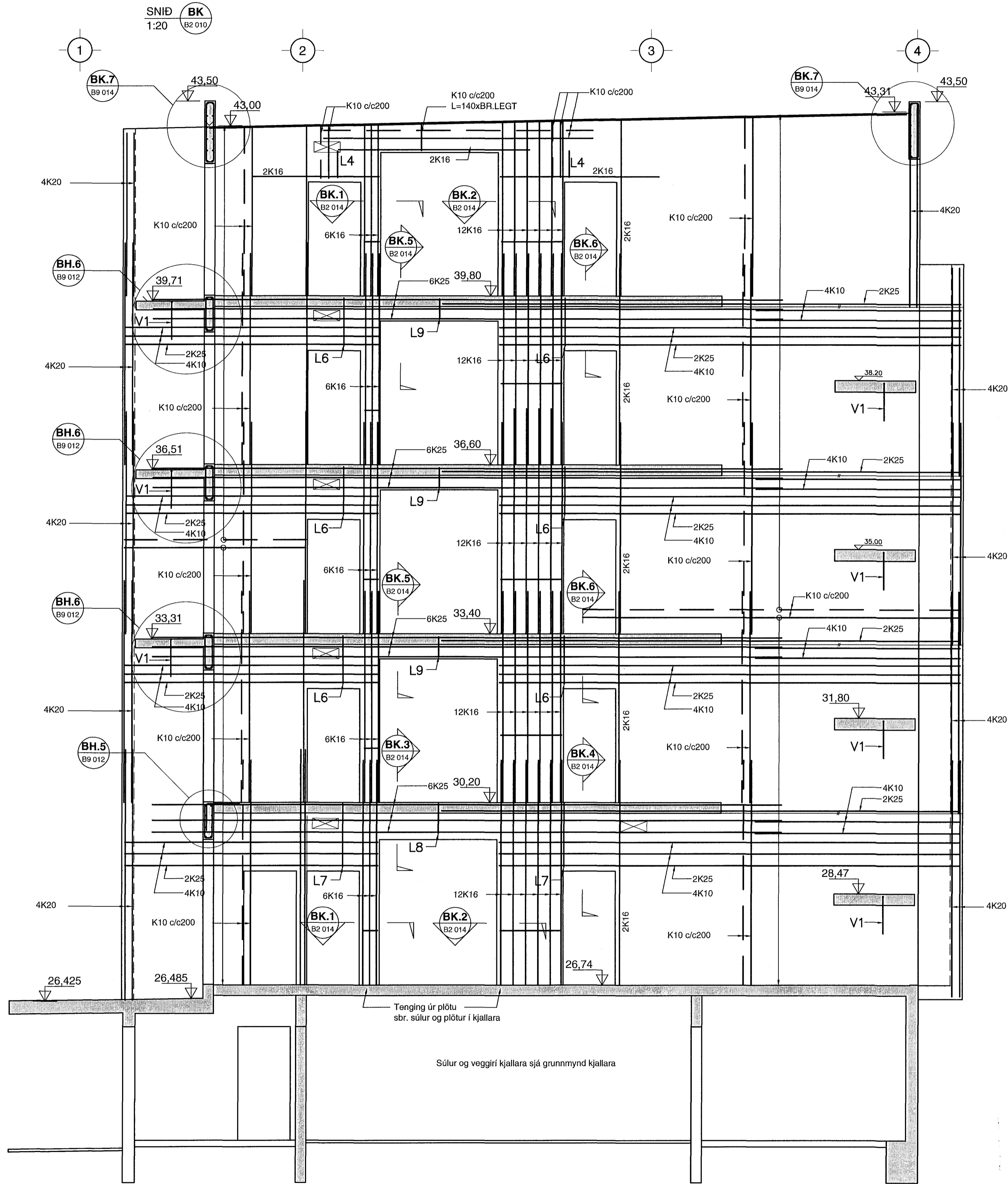

SKÝRINGAR

BENDING:
Almennt skal bending útveggja vera tvöföld grind, lóðrétt K10c/c250 og lárétt K10c/c200 nema annað sé tekið fram.

Almennt skal bending innveggja vera tvöföld grind, lóðrétt K10c/c300 og lárétt K10c/c200 nema annað sé tekið fram.

Almennt skal tengibending útveggjar og steypra plata vera tvöföldar tengjárnaskúffur með K10 c/c200 og 2 K12 í lykkjum tengjárnna.

Tengjárn upp í veggri efri hæðar standa minnst skeytilengd upp úr plötu

HK = Steypukóti

TILVÍSANIR:

Almennar skýringar: sjá bl.nr.07244-B0 000

Málsetningar á veggjum: Teikning arkitekts

Göt í plötum og veggjum: sjá gataplön hverra hæðar

BROTPOLSFLOKKUR STEYPU C25

sjá einning á bl.nr.07244-B0 000

- V1 K10 c/c200, L=700x700 VINKILL
- L4 K10 c/c200, L=140x500 OPIN LYKKJA
- L5 K10 c/c200, L=140x860 OPIN LYKKJA
- L6 K10 c/c200, L=140x920 LOKUD LYKKJA
- L7 K10 c/c200, L=140x1180 LOKUD LYKKJA
- L8 K10 c/c200, L=140x560 LOKUD LYKKJA
- L9 K10 c/c200, L=140x400 LOKUD LYKKJA

DALSHRAUN 3

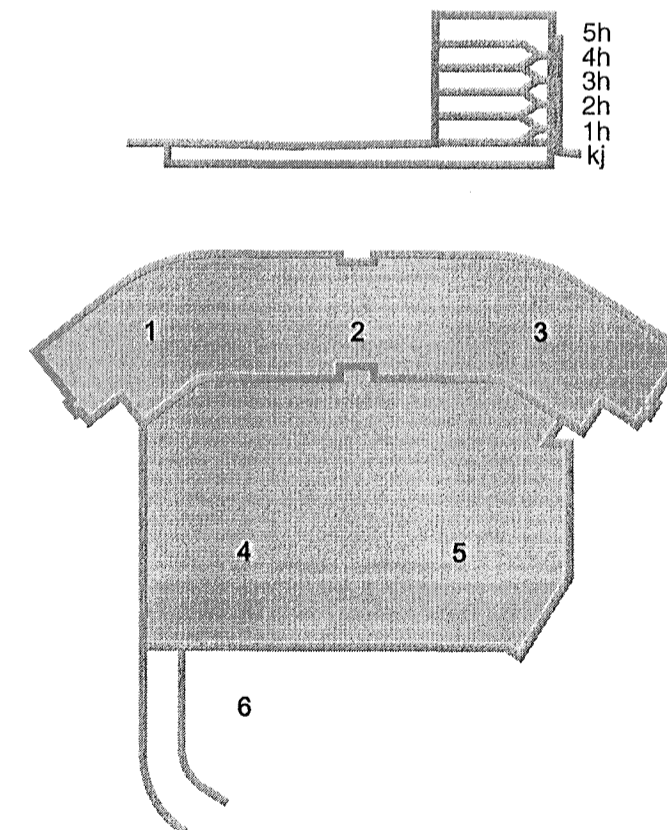

Útg. Dags. Skýring. Harnað/Yfirfarid



VERKFRÆÐISTOFA

BÆJARHRAUN 20 • 220 HAFNARFJÖRÐUR • KENNIT. 710796-2999
vsb@vsb.is • Sími 585 8600 • Fax 585 8610 • www.vsb.is

Artun sérhönnuðar
Björn Guðafsson
Kt. 190550-4989 • bjorn@vsb.is *Björn Guðafsson*

DALSHRAUN 3
HAFNARFIRÐI

Verkhliut
Búðarvirki
Plötur og veggir 1-5 hæð
Sníð og sémyndir

Harnað	Teknað	Yfirfarid	Kvarði	Síða
SJ	SJ	BG	1:50 / 1:20	A1
Dags.	Verkefni	Teikning	Útgáfa	
21.05.2008	07244	B9 014		

ÚTI
ARKITEKTAR
Jón Þór Þorvaldsson AÍ, FSSA
Kt. 021256 7579